



**25
GTV**

**KATALOG
PRODUKTÓW**

PRODUCT CATALOGUE

КАТАЛОГ ПРОДУКЦИИ

PL

GTV to międzynarodowy producent akcesoriów meblowych i oświetlenia. Jest jedną z najdynamiczniej rozwijających się firm w Polsce. Spółka obecna jest na kilkudziesięciu rynkach w Europie, Azji i Ameryce, a produkty z logo GTV znajdują się w milionach domów i biur na całym świecie. GTV jest firmą w 100% z polskim kapitałem. Spółka dysponuje własnym zapleczem techniczno-logistycznym umożliwiającym swobodne prowadzenie działalności o ogólnoświatowym zasięgu. Siedziba firmy to nowoczesne, w pełni zinformatywowane centrum logistyczne w Pruszkowie, w pobliżu autostrady A2. Na jego terenie znajduje się biurowiec oraz dwa magazyny o powierzchni 27 000 m kw. z wydzielonymi składami celnymi, mieszczące 35 000 europalet. Portfolio GTV to jedna z najbardziej kompletnych ofert na rynku. Obejmuje kilka tysięcy produktów, w kilkudziesięciu grupach produktowych, w tym m.in.: zawiasy, prowadnice, podnośniki, uchwyty, wyposażenie garderoby i kuchni oraz oświetlenie LED.

EN

GTV is an international producer of furniture accessories and LED lighting. GTV has over 20 years of experience in cooperation with the largest furniture manufacturers in the world and millions of customers using the company's products. Today GTV is one of the international leaders in distribution of furniture accessories and LED lighting, present on dozens of markets worldwide. GTV's headquarter is a modern logistics center, located 25 km from the center of the Polish capital, Warsaw. GTV's head office is a four-story office building and two warehouses on an area of 27000 square meters with storage capacity of over 35,000 euro pallets. With its modern infrastructure, the company is able to fulfill orders from all over the world at the time indicated by the customer. GTV implementing its long-term business strategy, actively promotes its products by participating in the world's most prestigious trade fairs e.g. in Russia, Germany, Italy, Poland, Brazil. Professional service, competent team of specialists and transparent procedures allow us to effectively meet the needs of business partners.

RU

GTV – это международный производитель мебельной фурнитуры и освещения. Мы работаем в десятках стран Европы, Азии и Америки, а продукция с логотипом GTV известна во всем мире. GTV – это современный, полностью информатизированный логистический центр возле Варшавы. На его территории находится офисное здание и два склада площадью 27 000 м2 с отдельными таможенными складами вместимостью 35 000 европаллет. Дополнительно фирма располагает складскими помещениями площадью почти 5000 квадратных метров. Ассортимент компании GTV включает несколько тысяч наименований продукции: петли, направляющие, подъемники, ручки, оснащение для гардероба и кухни, светодиодное освещение.





GTV

FURNITURE
ACCESSORIES

- PL** GTV Furniture Accessories, marka obecna na rynku od ponad dwadzieścia lat to niekwestionowany lider dostarczający najbardziej kompletne portfolio akcesoriów dla branży meblarskiej. Dzięki przemyślanej strategii rozwoju, marka oferuje nieosiągalną dla innych firm relację ceny do jakości, dostarczając funkcjonalne oraz zaprojektowane zgodnie z najnowszymi trendami produkty w przystępnych cenach.
- EN** GTV Furniture Accessories brand is present on the market for over 20 years, building its position as one of the international leaders. The company is present in Europe, Asia and America, whereas products with the GTV logo are to be found in millions of households and offices worldwide. Thanks to carefully planned strategy and logistics, GTV can offer products with an unreachable for other companies price to quality ratio.
- RU** Мебельная фурнитура с логотипом GTV известна на рынке уже более двадцати лет, а портфолио компании является одним из наиболее полных предложений на мебельном рынке. Благодаря продуманной стратегии развития, эффективному управлению и открытости к новым идеям, компания GTV быстро стала лидером в дистрибуции мебельной фурнитуры. Секрет успеха компании заключается в предоставлении продукции высокого качества по приемлемой цене.

GTV

SLIDING DOOR
SYSTEMS

- PL** GTV Sliding Door Systems, to marka która powstała w 2014 r. z myślą o profesjonalistach poszukujących rozwiązań ułatwiających i przyspieszających montaż drzwi przesuwanych. Systemy przesuwne zostały zaprojektowane przez naszych konstruktorów, dla których inspiracją były opinie polskich stolarzy. Dzięki tej owocnej współpracy powstał produkt, który nie tylko przekonuje praktycznymi, konstrukcyjnymi ulepszeniami. Są to również szczególnie decydujące o przewadze produktu jak unikatowy materiał, z którego wykonane zostały kółka w systemach jezdnych.
- EN** GTV Sliding Door Systems is a brand developed in 2014, for professionals seeking reliability and highest quality. Our systems have been created to meet the needs, of the most demanding customers. The idea behind the systems was inspired by carpenters, who tend to look for solutions, that will make their work more effective. GTV Sliding Door Systems offer not only practical constructional improvements. But also highest quality of components. The whole system is based on reliable elements, especially rollers thanks to which this system stands out of the competition. All of the functional accessories have been carefully selected and underwent thorough strict quality control.
- RU** Раздвижные системы GTV - бренд, созданный в 2014 году с мыслью о профессионалах, ищущих новые возможности, позволяющие ускорить процесс установки раздвижных дверей. Раздвижные системы GTV были zaprojektowane по инициативе производителей мебели и являются авторской разработкой инженеров компании GTV. В результате плодотворной работы был создан продукт, интересный не только своими техническими решениями, но и отличающийся качеством используемого материала в нижних ходовых элементах.

GTV

LIGHTING

- PL** Marka GTV Lighting została wprowadzona na rynek 2007 r. oferując rozwiązania oświetleniowe przeznaczone do biur, budynków przemysłowych, magazynowych i użyteczności publicznej opartych na technologii LED. Portfolio zawiera również produkty LED dla klientów indywidualnych – źródła LED, oświetlenie meblowe. GTV Lighting to szeroka i kompletna oferta, elastyczność w podejściu do partnerów biznesowych a także serwis.
- EN** The GTV Lighting brand was launched in 2007, it has been created, to provide professional lighting solutions for offices, industrial buildings and warehouses - based on LED technology. The portfolio also includes LED solutions for private consumers – home and garden lighting, furniture lighting. GTV Lighting offers also a wide and complete portfolio of services, such as lighting planning consulting.
- RU** Товарная группа GTV освещение появилась в ассортименте компании в 2007 году и представляет собой подборку интересных световых решений для офисов, промышленных зданий, складских помещений, общественных зданий, а также решений подходящих индивидуальным клиентам – источники светодиодного освещения и освещение для мебели. GTV освещение предлагает широкий спектр продукции и гибкость в подходе к бизнес-партнёрам и услугам, которые мы предоставляем.

GTV

decor

- PL** GTV Decor to marka oświetlenia dekoracyjnego, która została stworzona w zgodzie z najnowszymi trendami w światowym designie. Naszym celem jest dotarcie do Klientów o różnorodnych preferencjach i wspieranie ich w indywidualnych projektach mieszkaniowych. Dostarczamy oświetlenie dekoracyjne, które zapewni jakościowe korzystanie z przestrzeni. Śledzimy bieżące trendy we wzornictwie, w których indywidualny styl wnętrza odzwierciedla tożsamość Klienta. Bogactwo wzorów i modna, stonowana kolorystyka sprawiają, że w portfolio GTV DECOR każdy znajdzie coś dla siebie. Odcienie bieli, szarości, czerni, przemyślane detale oraz różnorodność lamp – to wszystko można odnaleźć w naszych produktach, które liczą ponad 70 wzorów opraw.
- EN** GTV Decor is a brand of decorative lighting created in accordance with the latest trends in global design. Our aim is to reach out to customers with diverse preferences and support them in their individual home projects. We provide decorative lighting that ensures quality use of the space. We follow current trends in design, in which the individual style of the interior reflects the identity of the client. With the abundance of designs and fashionable, subdued colours, the GTV DECOR portfolio has a lot to offer to everyone. Shades of white, grey, black, well thought-out details and a variety of lamps - all this can be found in our products, including more than 70 luminaire designs.
- RU** GTV Decor — бренд декоративного освещения, созданный в соответствии с последними тенденциями мирового дизайна. Наша цель – найти клиентов с различными предпочтениями и поддержать их в реализации индивидуальных жилых проектов. Мы создаем декоративное освещение, которое обеспечит качественное использование пространства. Следим за современными тенденциями в дизайне, в которых стиль интерьера отражает индивидуальность заказчика. Богатство решений и модные цвета означают, что каждый найдет что-то для себя в ассортименте GTV DECOR. Оттенки белого, серого, черного, продуманные детали и разнообразие форм ламп – все это можно найти в нашей продукции, которая включает в себя более 70 дизайнов светильников.

AKCESORIA FUNKCYJNE FUNCTIONAL ACCESSORIES ФУНКЦИОНАЛЬНАЯ ФУРНИТУРА

Zawiasy Hinges Петли	67 – 103
Amortyzatory Buffers Амортизаторы	104 – 109 120 – 123
Podnośniki Lifts Подъёмники	110 – 119
Prowadnice Slides Направляющие	124 – 161
Systemy szuflad Drawer systems Выдвижные ящики	162 – 199
Elementy łączeniowe Brackets and fittings Соединительные элементы	203 – 232
Listwy Work top strip Планки для столешниц	233 – 235
Mocowania do rur Rails accessories and fittings Крепления для труб	236 – 255
Wyposażenie garderoby Wardrobe accessories Наполнение для шкафов-купе	256 – 279
Akcesoria kuchenne Kitchen accessories Кухонные аксессуары	200 – 202 280 – 301
Akcesoria biurowe Office accessories Аксессуары для офиса	302 – 314
Inne Other Другие	315 – 319

AKCESORIA DEKORACYJNE DECORATIVE ACCESSORIES ЛИЦЕВАЯ ФУРНИТУРА

Uchwyty Handles Ручки	322 – 411
Wieszaki Hooks Крючки	412 – 429

Wsporniki Shelf supports Полкодержатели	430 – 437
Nóżki meblowe Furniture legs Мебельные ножки	438 – 458
Nogi meblowe Furniture legs Мебельные опоры	459 – 475
Rotki meblowe Furniture castors Мебельные колёсики	476 – 481

SYSTEMY PRZESUWNE SLIDING DOOR SYSTEMS РАЗДВИЖНЫЕ СИСТЕМЫ

Dolny układ jezdny Bottom-running systems Нижняя ходовая система	486 – 516
Górny układ jezdny Top-running systems Верхняя ходовая система	517 – 521

OŚWIETLENIE MEBLOWE FURNITURE LIGHTING МЕБЕЛЬНОЕ ОСВЕЩЕНИЕ

Taśmy LED LED strips Светодиодные ленты	526 – 531
Profile LED LED profiles Профили LED	532 – 563
Oprawy LED LED fittings Светодиодные светильники	563 – 573
Akcesoria Accessories Аксессуары	574 – 601
Przedłużacze biurkowe Desk power sockets Выдвижные удлинители	602 – 623

AKCESORIA FUNKCYJNE
FUNCTIONAL ACCESSORIES
ФУНКЦИОНАЛЬНАЯ ФУРНИТУРА



67

ZM-OT-STANDARD



67

ZM-HCPR09H04-BE-2BAG



68

ZM-HCPR08H04-BE-2BAG



68

ZM-HCPR07H04-BE-2BAG



69

ZM-DHC09-3DBE0



69

ZM-DHC08-3DBE0



70

ZM-DHC07-3DBE0



70

ZM-EHC09BE0



72

ZM-EHC08BE0



72

ZM-EHC07BE0



73

ZM-EHC09H04-BE



73

ZM-EHC08H04-BE



74

ZM-EHC07H04-BE



74

ZM-EHC09-3DBE0



75

ZM-EHC08-3DBE0



75

ZM-EHC07-3DBE0



76

ZM-CNHC09BR2



77

ZM-CNHC08BR2



77

ZM-CNHC07BR2

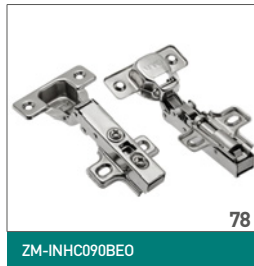

78

ZM-INHC090BE0

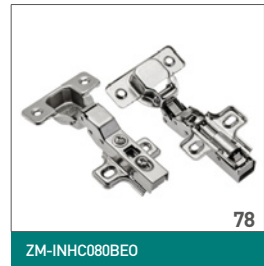

78

ZM-INHC080BE0



79

ZM-INHC070BE0



79

ZM-HCKT30-BE-S



80

ZM-HCKT45-BE-S



80

ZM-HCKT45-3DBE0-S



81

ZM-HCKT90-BE-S



81

ZM-HCKT90-3DBE0-S

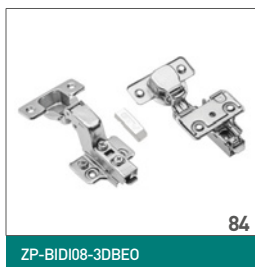

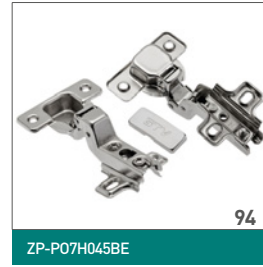

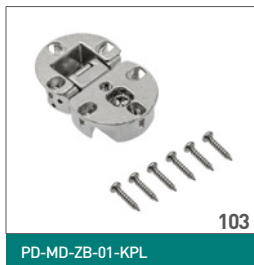

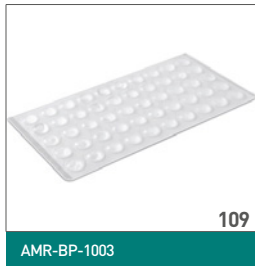
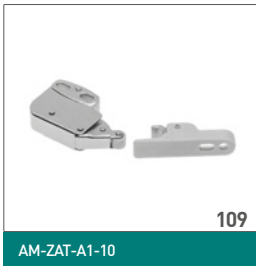
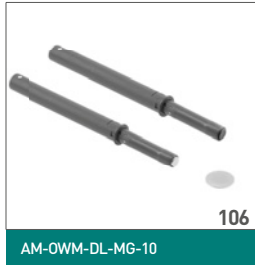

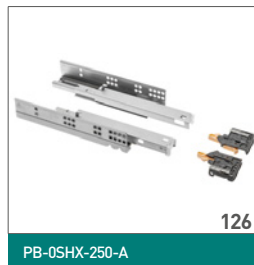
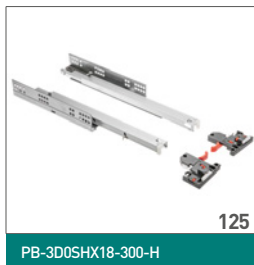







164

PB-AXISPRO-KPL300D



165

PB-AXISPRO-KPL69-450-60



165

PB-AXISPRO-WEWMOCA



166

PB-AXISPRO-WEWMOCB



166

PB-AXISPRO-WEWMOCC



167

PB-AXISPRO-WEWMOCD



167

PB-AXISPRO-ZESWEW-A AXISPRO



168

PB-AXISPRO-ZESWEW-B AXISPRO



168

PB-AXISPRO-ZESWEW-C AXISPRO



169

PB-AXISPRO-ZESWEW-D AXISPRO



169

PB-AXISPRO-RELKW300



169

PB-AXISPRO-ZNACZ-FRONT



171

PB-KW-KPL250A



171

PB-KW-KPL250B



172

PB-KW-KPL250C



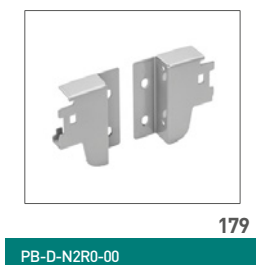
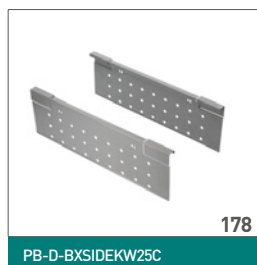
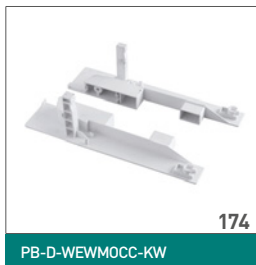



180

PB-D-MHG04-KW



181

PB-D-MATRYCA



181

PB-D-ZNACZ-0



183

PB-D-KPL300A



184

PB-D-KPL300B



184

PB-D-KPL300C



185

PB-D-REL2500



185

PB-D-WEWMOCA

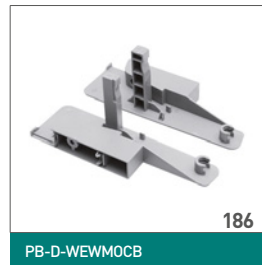

186

PB-D-WEWMOCB



186

PB-D-WEWSZKLC



187

PB-D-WEWMOCC



187

PB-D-ZESWEW-C



188

PB-D-WEWORC-A

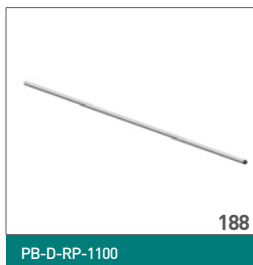

188

PB-D-RP-1100



189

PB-D-ZR-00-0

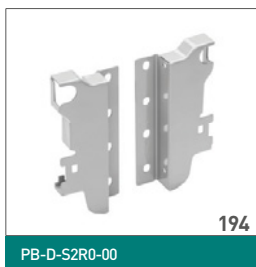
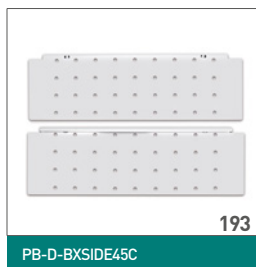
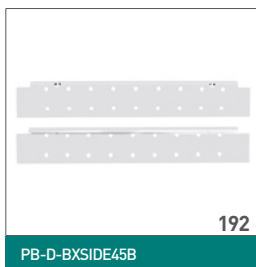

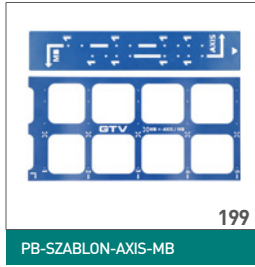
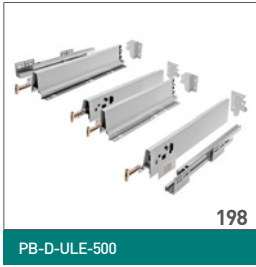





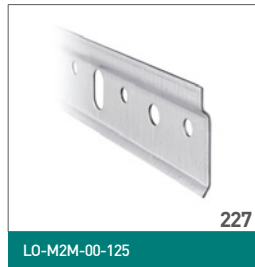

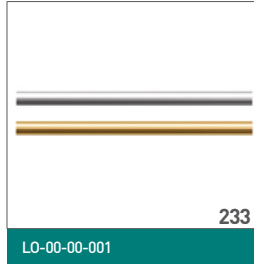









261

WG-PRZEG60-10



262

WG-WSPOD60-10



262

WG-WSPOD60



263

WG-RRPSET-A-10

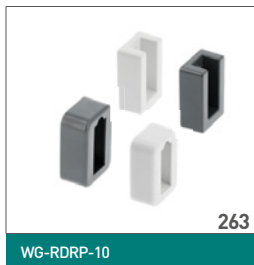

263

WG-RDRP-10



264

PG-ST83115-10A



266

W-WOBU60-BP-60



268

W-WSPD60-BP-60



270

W-WKO60-BP-60



272

W-WKRP-BP-60



273

KO-SR100-30-10



274

WW-WSP00-01



274

WW-WSP00-01



275

WW-WUBR00-01



275

WW-WSL250-01



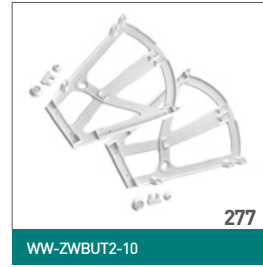



289

PB-91024160V



290

PB-93004162601



292

KO-WMC450-60



293

KO-UMC450-60



294

KO-150B0-60



296

KO-300B0-60



297

KO-B0150TD-OC



298

OC-A0150-06



298

OC-A0660-06



299

OC-2PV340-02-18



300

OC-A0450-06



300

OC-A0350K-06



301

OC-A0460D-06

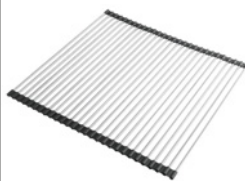

301

OC-E0707D-CZ



302

PU-KEY027-20



302

PU-KEYM27-20

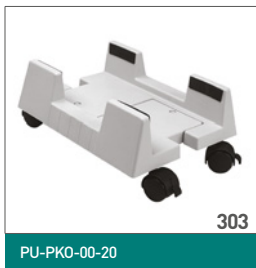

303

PU-PK0-00-20



303

HB-USB-4X-60



304

LB-K80X80-05



304

LB-80X100-05



305

LB-80X160-05



305

LB-80X280-05



306

LB-80X500-05



306

PM-LBF160-01



307

PM-PLF160-05



308

ZZ-KM-138-01

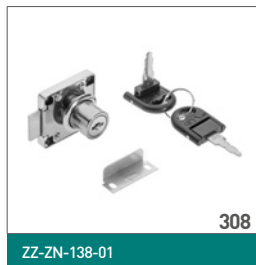

308

ZZ-ZN-138-01



309

ZZ-CF-138-01



309

ZZ-KLMASTER



310

ZZ-ZN-338-01-S



AKCESORIA DEKORACYJNE
DECORATIVE ACCESSORIES
ЛИЦЕВАЯ ФУРНИТУРА



322

UZ-MONZA160-06



322

UZ-MONA-128-01-10



323

UA-ARS096-20



324

UZ-G2-160-01



324

UZ-TIVOL-192-01



325

UZ-BAGIO-128-01

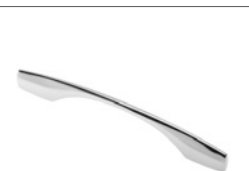

326

UZ-ANCON-128-01

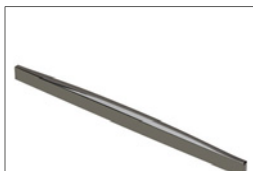

326

UZ-KATAN-320-01



327

UZ-40-032-01



327

UZ-55-025-05

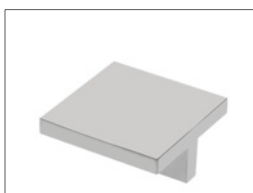

328

UZ-60-032-01



328

UZ-133128-01

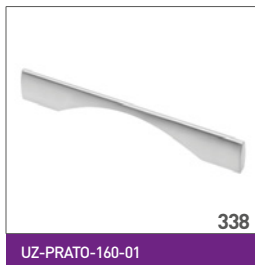

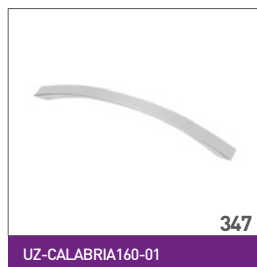
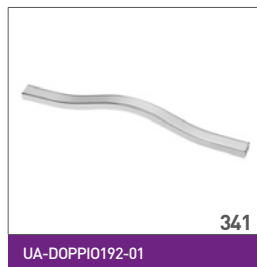
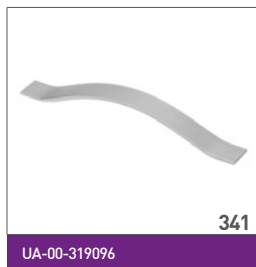

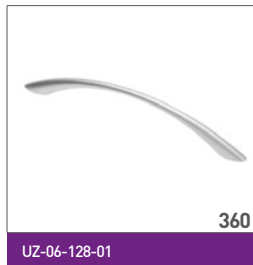
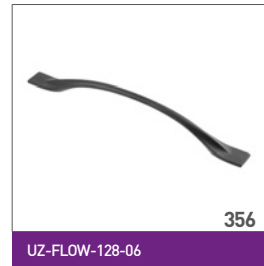







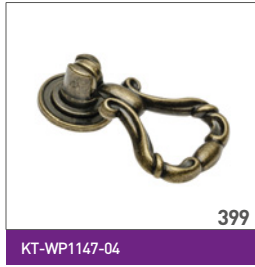
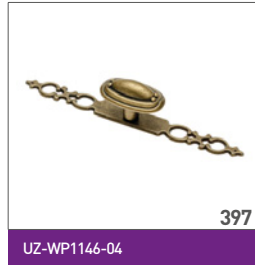



405

UZ-LUCCA128-01



405

GZ-CRPA20-01



406

GZ-CRPB20-01



406

GZ-CRPC30-01



407

ID-GZ-CRPJ30-01



408

UM-BLOCK-ZL



408

UM-CLOUD-NB



408

UM-STAR-NB



408

UM-BUTTON-NB



408

UM-FLAMING-SZ



408

UM-HEART-RZ



408

UM-CROWN-RZ



408

UM-TWITT-ZL

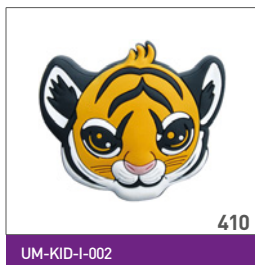

410

UM-KID-I-002



410

UM-KID-P-001

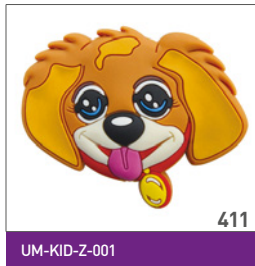
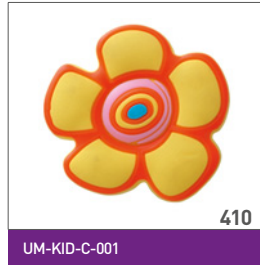



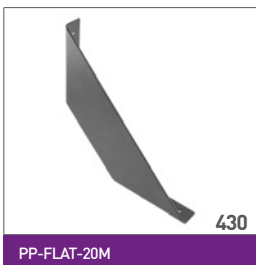
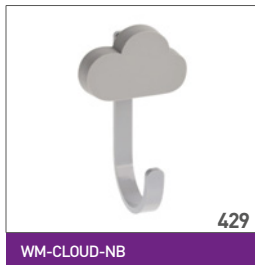
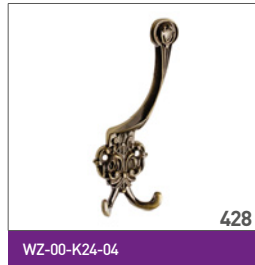











**SYSTEMY PRZESUWNE
SLIDING DOOR SYSTEMS
РАЗДВИЖНЫЕ СИСТЕМЫ**



A-R18ERG-270-05



A-R16ERG-220-05



A-R18GE02-270-05



A-RNOV2-270-05



A-R18NOVS-270-05



A-R19NOVS-300-05



A-R18CARO-270-05



A-R18VIS-270-05



A-R18NERO-270-05



A-R19NERO-300-05



A-R18COTE-270-05



A-R18LOCA-305-05

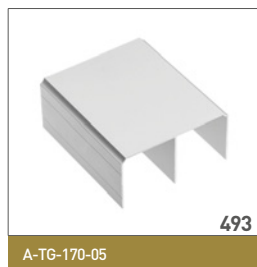
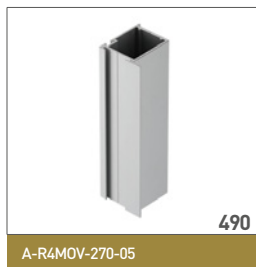

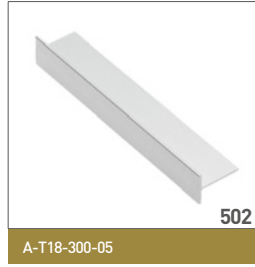
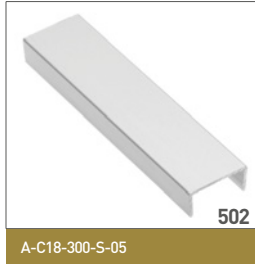
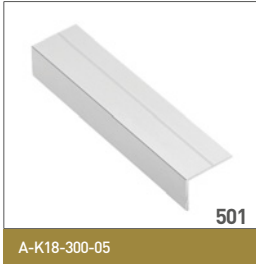

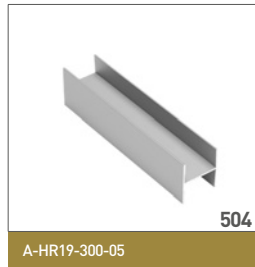
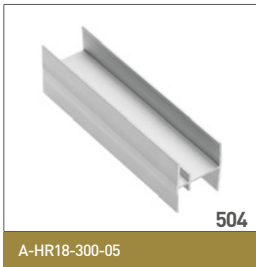

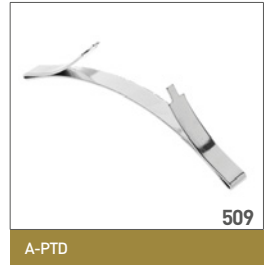



514

A-B63-32



514

A-SOFT-30



514

A-MSOFT-RAMA



514

A-SOFT-30Z



515

A-MSOFT-ADAPT



515

ZZ-SP-105-05



515

A-PW-RC-D0C



516

A-TMITO-200-00



516

A-MITO-PLUS



517

A-SN-FSET



518

A-SN-HSET1



519

A-SN-SDP-TU

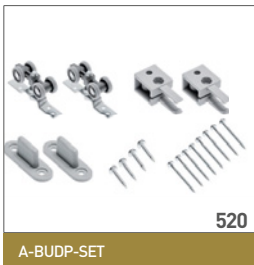

520

A-BUDP-SET



521

A-SN-LOFT-200-20MN

**OŚWIETLENIE MEBLOWE
FURNITURE LIGHTING
МЕБЕЛЬНОЕ ОСВЕЩЕНИЕ**



526

LD-3528-300-20-ZB



528

LD-3528-300-20-ZB-50



528

LD-2835-24V-300-20-ZB



529

LD-ZL5RGB150-00



530

LD-COB12V-20-ZB



531

LD-NF-12V6x12-65-ZB

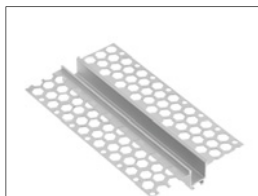

532

PA-GLAXGKL3M-00C

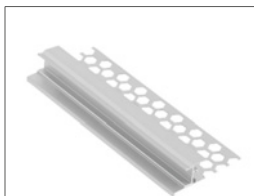

534

PA-GLAXGKS3M-00C

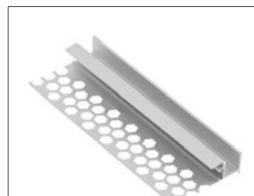

536

PA-GLAXGKW3M-00C



538

PA-GLAXGKWK3M-00C



540

PA-GLAXGKZK3M-00C

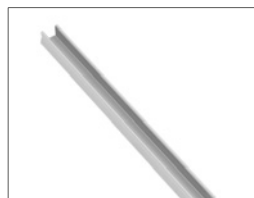

541

PA-GLAXMICNK-AL







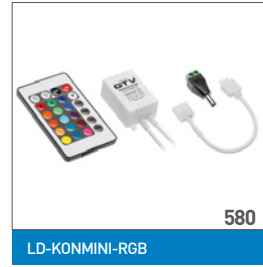



584

LD-KONML-WIFI



584

LD-KONML-AD



586

AE-WDBP1-10N



586

AE-WDBP2CCT-10N



588

AE-WBEZDC-10S



588

AE-WBEZDK15-10



589

AE-WBEZDPIR-10



589

AE-WBEZDPIR2-20



590

AE-WBBUNI-10DIM



590

AE-WDSB-10DIM



591

AE-WBEZD-NB



591

AE-WPDRW-00



592

AE-WLPR-60



592

AE-WLB01-10



593

AE-WLIP44-15



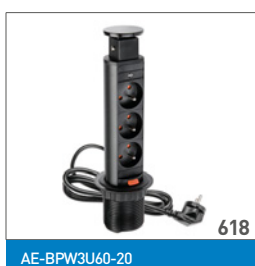



**AKCESORIA FUNKCYJNE
FUNCTIONAL ACCESSORIES
ФУНКЦИОНАЛЬНАЯ ФУРНИТУРА**

Zawiasy Hinges Петли	67 – 103
Amortyzatory Buffers Амортизаторы	104 – 109 120 – 123
Podnośniki Lifts Подъёмники	110 – 119
Prowadnice Slides Направляющие	124 – 161
Systemy szuflad Drawer systems Выдвижные ящики	162 – 199
Elementy łączeniowe Brackets and fittings Соединительные элементы	203 – 232
Listwy Work top strip Планки для столешниц	233 – 235
Mocowania do rur Rails accessories and fittings Крепление для труб	236 – 255
Wyposażenie garderoby Wardrobe accessories Наполнение для шкафов-купе	256 – 279
Akcesoria kuchenne Kitchen accessories Кухонные аксессуары	200 – 202 280 – 301
Akcesoria biurowe Office accessories Аксессуары для офиса	302 – 314
Inne Other Другие	315 – 319





MB

MODERN BOX

Orientacyjna ilość zawiasów puszkowych Ø35*

* Nie dotyczy modeli specjalnych o szerokim kącie otwarcia

Approximate amount of hinges Ø35*

* Not applicable for special hinges with wide opening angle

Приблизительное количество шарнирных петель Ø35*

* Не касается специальных моделей с широким углом открывания

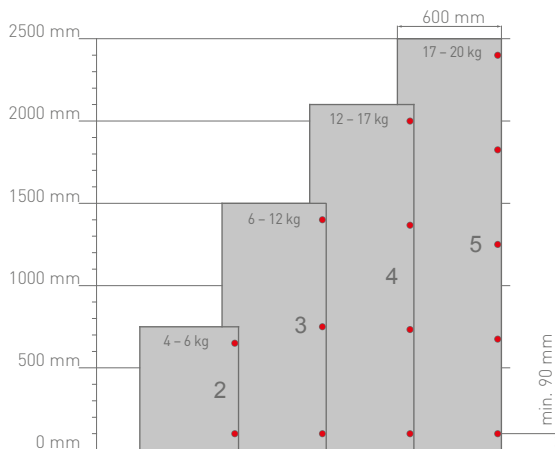

Orientacyjna ilość zawiasów puszkowych Ø26 oraz Ø35*

* Dotyczy modeli specjalnych o szerokim kącie otwarcia

Approximate amount of hinges Ø26 and Ø35*

* Applicable for special hinges with wide opening angle

Приблизительное количество шарнирных петель Ø26 и Ø35*

* Касается специальных моделей с широким углом открывания

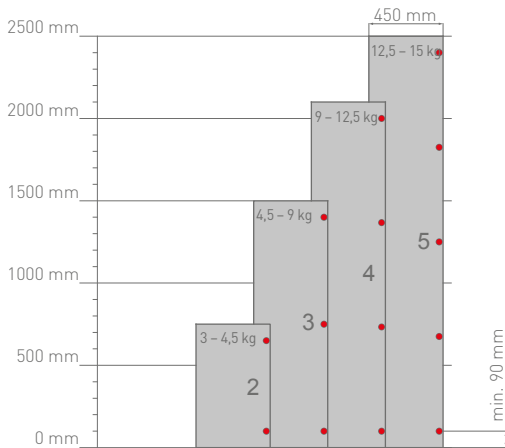

- Ilość użytych zawiasów jest zależna od wysokości, szerokości i ciężaru frontu.
- W celu zapewnienia stabilności odległość między zawiasami powinna być jak największa.
- Przed przystąpieniem do seryjnej produkcji należy przeprowadzić próbę montażu i sprawdzić poprawność funkcjonowania.
- Number of hinges that should be used, depends on the height, width and weight of the front.
- To ensure stability, the distance between the hinges should be as big as possible.
- Before starting mass production, mounting tests should be performed in order to ensure proper functioning.
- Количество использованных петель зависит от высоты, ширины и веса фасада.
- Для обеспечения стабильности, расстояние между петлями должно быть как можно больше.
- Перед началом серийного производства необходимо провести пробу монтажа и проверить исправность функциональности петель.

Mechanizm SoftMove
SoftMove mechanism
Механизм SoftMove

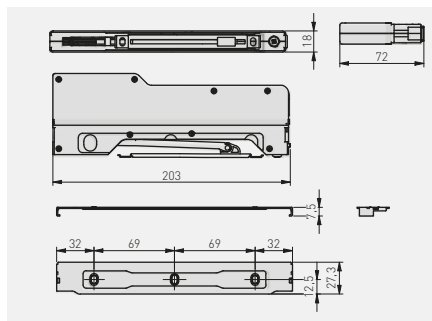

ZM-OT-STANDARD	stal, tworzywo
ZN-OT-HEAVY*	steel, plastic
	сталь, пластмасса



*Produkt dostępny na indywidualne zamówienie / Available for special orders / Товар доступен под заказ

Zawias puszkowy hydrauliczny ZM-HCPRO TWO WAY, nakładany
Cup hydraulic hinge ZM-HCPRO TWO WAY, overlay door
Петля скрытая гидравлическая ZM-HCPRO TWO WAY, накладная

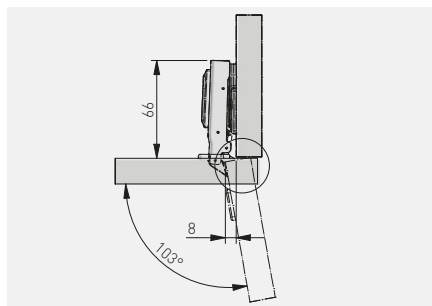

ZM-HCPRO09H04-BE-2BAG	H = 0	—	—	nikiel	stal
ZM-HCPRO09H04-ZE-2BAG		—	x 2	nickel ниль	steel сталь



Zawias puszkowy hydrauliczny ZM-HCPRO TWO WAY, bliźniaczy
 Cup hydraulic hinge ZM-HCPRO TWO WAY, twin overlay door
 Петля скрытая гидравлическая ZM-HCPRO TWO WAY, полунакладная

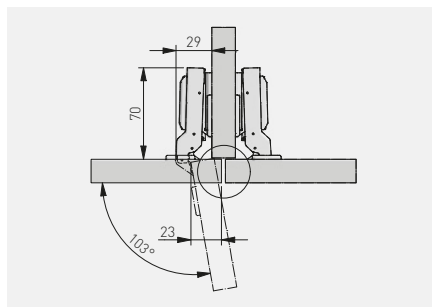

ZM-HCPR008H04-BE-2BAG	H = 0	—	—	nikiel	stal
ZM-HCPR008H04-ZE-2BAG		—	x 2	nickel	steel

Zawias puszkowy hydrauliczny ZM-HCPRO TWO WAY, wpuszczany
 Cup hydraulic hinge ZM-HCPRO TWO WAY, inset door
 Петля скрытая гидравлическая ZM-HCPRO TWO WAY, внутренняя

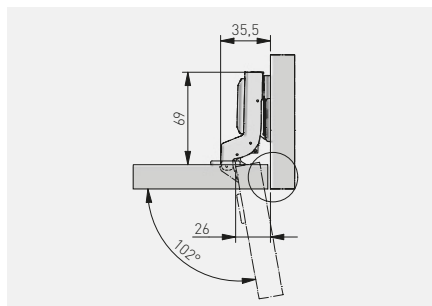

ZM-HCPR007H04-BE-2BAG	H = 0	—	—	nikiel	stal
ZM-HCPR007H04-ZE-2BAG		—	x 2	nickel	steel

Zawias hydrauliczny SOLID PLUS, nakładany
 Hydraulic cup hinge SOLID PLUS, overlay door
 Гидравлическая петля SOLID PLUS, накладная

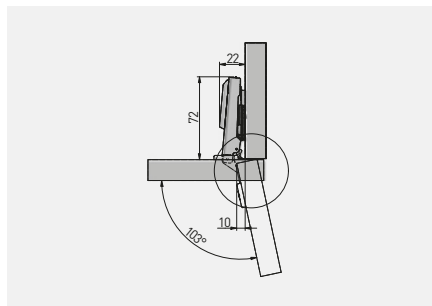

ZM-DCHC09-3DBEO	H = 0	—	—	nikiel nickel ннкель	stal steel сталь
ZM-DCHC09-3DZEO		—	x 2		



*Produkt dostępny na indywidualne zamówienie / Available for special orders / Товар доступен под заказ

Zawias hydrauliczny SOLID PLUS, bliźniaczy
 Hydraulic cup hinge SOLID PLUS, twin overlay door
 Гидравлическая петля SOLID PLUS, полунакладная

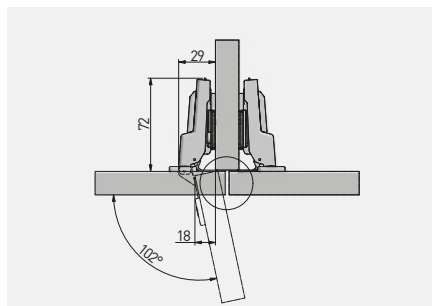

ZM-DCHC08-3DBEO	H = 0	—	—	nikiel nickel ннкель	stal steel сталь
ZM-DCHC08-3DZEO		—	x 2		



*Produkt dostępny na indywidualne zamówienie / Available for special orders / Товар доступен под заказ

Zawias hydrauliczny SOLID PLUS, wpuszczany
 Hydraulic cup hinge SOLID PLUS, inset door
 Гидравлическая петля SOLID PLUS, внутренняя

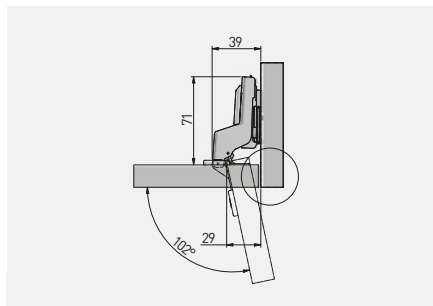

ZM-DCHC07-3DBEO	H = 0	—	—	nikiel nickel	stal steel
ZM-DCHC07-3DZEO		—	x 2	nikiel nickel	stal steel



*Produkt dostępny na indywidualne zamówienie / Available for special orders / Товар доступен под заказ

Zawias hydrauliczny ECHC, nakładany
 Hydraulic cup hinge ECHC, overlay door
 Гидравлическая петля ECHC, накладная

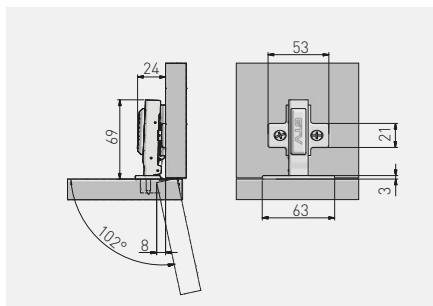

ZM-ECHC09BEO	H = 0	x 4	—	nikiel nickel	stal steel
ZM-ECHC09ZEO		x 2	x 2	nikiel nickel	stal steel



*Produkt dostępny na indywidualne zamówienie / Available for special orders / Товар доступен под заказ



Zawias hydrauliczny ECHC, bliźniaczy
 Hydraulic cup hinge ECHC, twin overlay door
 Гидравлическая петля ECHC, полунакладная

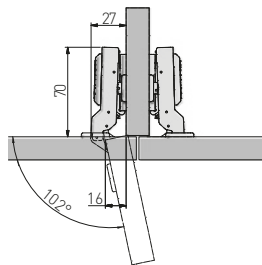

ZM-ECHC08BEO	H = 0	x 4	—	nikiel nickel	stal steel
ZM-ECHC08ZEO		x 2	x 2	nikiel nickel	stal steel



*Produkt dostępny na indywidualne zamówienie / Available for special orders / Товар доступен под заказ

Zawias hydrauliczny ECHC, wpuszczany
 Hydraulic cup hinge ECHC, inset door
 Гидравлическая петля ECHC, внутренняя

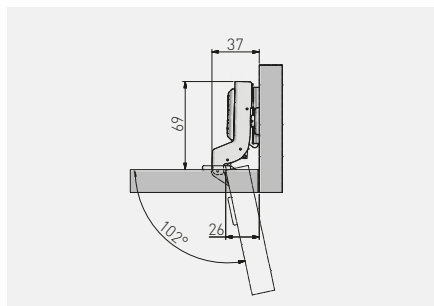

ZM-ECHC07BEO	H = 0	x 4	—	nikiel nickel	stal steel
ZM-ECHC07ZEO		x 2	x 2	nikiel nickel	stal steel



*Produkt dostępny na indywidualne zamówienie / Available for special orders / Товар доступен под заказ

Zawias hydrauliczny ECHC, nakładany
 Hydraulic cup hinge ECHC, overlay door
 Гидравлическая петля ECHC, накладная

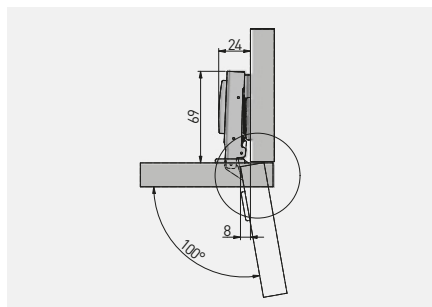

ZM-ECHC09H04-BE	H = 0	x 6	—	nikiel nickel никель	stal steel сталь



*Produkt dostępny na indywidualne zamówienie / Available for special orders / Товар доступен под заказ

Zawias hydrauliczny ECHC, bliźniaczy
 Hydraulic cup hinge ECHC, twin overlay door
 Гидравлическая петля ECHC, полунакладная

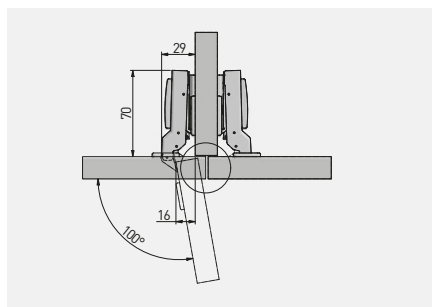

ZM-ECHC08H04-BE	H = 0	x 6	—	nikiel nickel никель	stal steel сталь



*Produkt dostępny na indywidualne zamówienie / Available for special orders / Товар доступен под заказ

Zawias hydrauliczny ECHC, wpuszczany
 Hydraulic cup hinge ECHC, inset door
 Гидравлическая петля ECHC, внутренняя

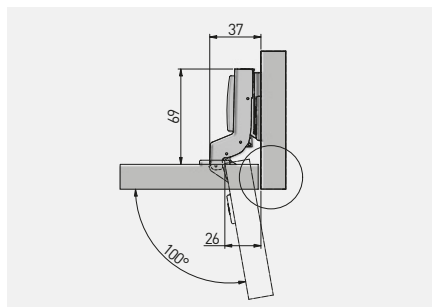

ZM-ECHC07H04-BE	H = 0	x 6	—	nikiel nickel НИКЕЛЬ	stal steel СТАЛЬ



*Produkt dostępny na indywidualne zamówienie / Available for special orders / Товар доступен под заказ

Zawias hydrauliczny ECHC3D prosty, z regulacją mimośrodową
 Hydraulic cup hinge ECHC3D with eccentric adjustment, straight
 Гидравлический шарнир ECHC3D прямой

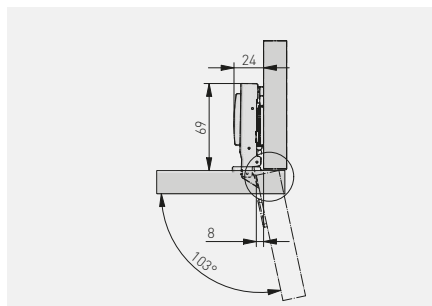

ZM-ECHC09-3DBE0	H = 0	x 4	—	nikiel nickel НИКЕЛЬ	stal steel СТАЛЬ



*Produkt dostępny na indywidualne zamówienie / Available for special orders / Товар доступен под заказ

Zawias hydrauliczny ECHC3D półwpuszczany z regulacją mimośrodową
 Hydraulic cup hinge ECHC with eccentric adjustment, half-overlay door
 Полууглубленный гидравлический шарнир ECHC3D

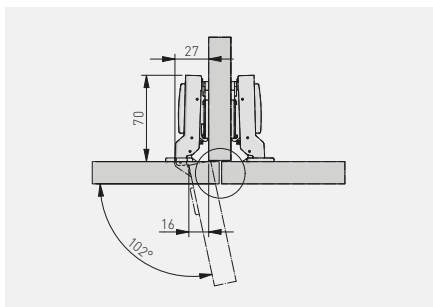

ZM-ECHC08-3DBE0	H = 0	x 4	—	nikiel nickel ннкель	stal steel сталь



*Produkt dostępny na indywidualne zamówienie / Available for special orders / Товар доступен под заказ

Zawias hydrauliczny ECHC3D wpuszczany, z regulacją mimośrodową
 Hydraulic cup hinge ECHC with eccentric adjustment, inset door
 Гидравлический шарнир ECHC3D

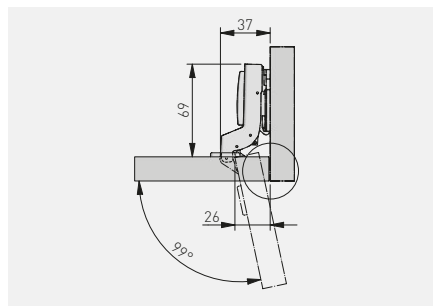

ZM-ECHC07-3DBE0	H = 0	x 4	—	nikiel nickel ннкель	stal steel сталь



*Produkt dostępny na indywidualne zamówienie / Available for special orders / Товар доступен под заказ

Zawias hydrauliczny CNHC z regulacją mimośrodową, nakładany
 Hydraulic cup hinge CNHC with eccentric adjustment, overlay door
 Гидравлическая петля CNHC с эксцентриком, накладная

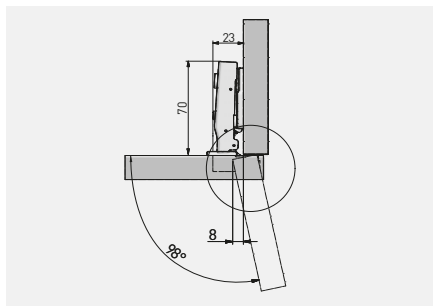

ZM-CNHC09BR2	H = 0	-	-	nikiel nickel нیکель	stal steel сталь



Zawias hydrauliczny CNHC z regulacją mimośrodową, bliźniaczy
 Hydraulic cup hinge CNHC with eccentric adjustment, twin overlay door
 Гидравлическая петля CNHC с эксцентриком, полунакладная

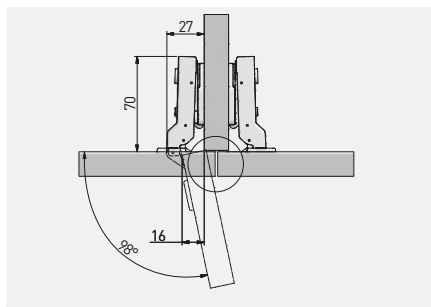

ZM-CNHC08BR2	H = 0	-	-	nikiel nickel никель	stal steel сталь



Zawias hydrauliczny CNHC z regulacją mimośrodową, wpuszczany
 Hydraulic cup hinge CNHC with eccentric adjustment, inset door
 Гидравлическая петля CNHC с эксцентриком, внутренняя

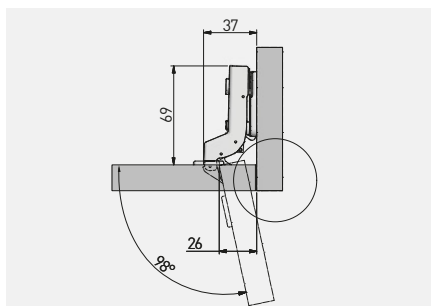

ZM-CNHC07BR2	H = 0	-	-	nikiel nickel никель	stal steel сталь



Zawias hydrauliczny INHC, nakładany
 Hydraulic cup hinge INHC, overlay door
 Гидравлическая петля INHC, накладная

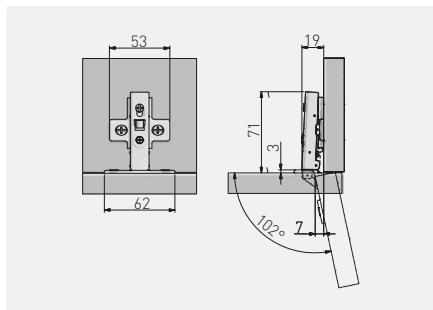

ZM-INHC090BEO	H = 0	—	—	nikiel nickel	stal steel
ZM-INHC090ZEO		—	x 2	никель	сталь



*Produkt dostępny na indywidualne zamówienie / Available for special orders / Товар доступен под заказ

Zawias hydrauliczny INHC, bliźniaczy
 Hydraulic cup hinge INHC, twin overlay door
 Гидравлическая петля INHC, полунакладная

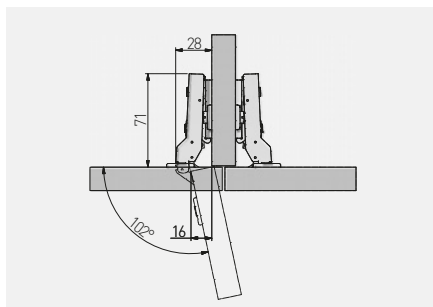

ZM-INHC080BEO	H = 0	—	—	nikiel nickel	stal steel
ZM-INHC080ZEO		—	x 2	никель	сталь



*Produkt dostępny na indywidualne zamówienie / Available for special orders / Товар доступен под заказ

Zawias hydrauliczny INHC, wpuszczany
 Hydraulic cup hinge INHC, inset door
 Гидравлическая петля INHC, внутренняя

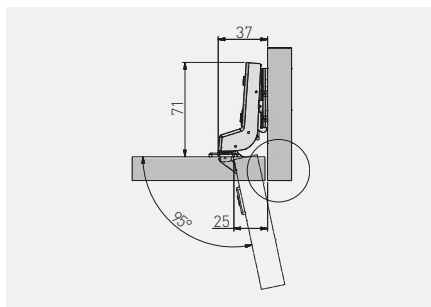

ZM-INHC070BEO	H = 0	—	—	nikiel nickel	stal steel
ZM-INHC070ZEO		—	x 2	никель nickel	сталь steel



*Produkt dostępny na indywidualne zamówienie / Available for special orders / Товар доступен под заказ

Zawias kątowy 30°, hydrauliczny HCKT
 Hydraulic corner cup hinge 30° HCKT
 Угловая петля 30°, гидравлическая HCKT

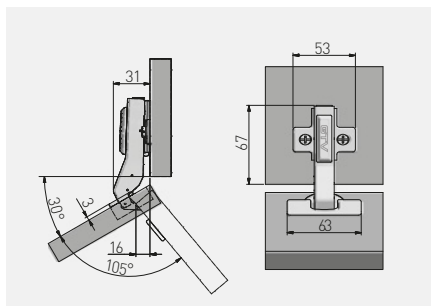

ZM-HCKT30-BE-S	H = 0	x 4	—	nikiel nickel	stal steel
ZM-HCKT30-ZE-S		x 2	x 2	никель nickel	сталь steel



*Produkt dostępny na indywidualne zamówienie / Available for special orders / Товар доступен под заказ

Zawias kątowy 45° hydrauliczny HCKT
 Hydraulic corner cup hinge 45° HCKT
 Угловая петля 45°, гидравлическая HCKT

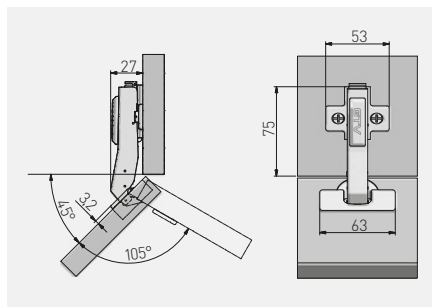

ZM-HCKT45-BE-S	H = 0	x 4	—	nikiel nickel нیکель	stal steel сталь
ZM-HCKT45-ZE-S		x 2	x 2		



*Produkt dostępny na indywidualne zamówienie / Available for special orders / Товар доступен под заказ

Zawias kątowy 45° HCKT z regulacją mimośrodową
 Corner hinge 45° HCKT with eccentric adjustment
 Угловая петля 45° HCKT с эксцентриком

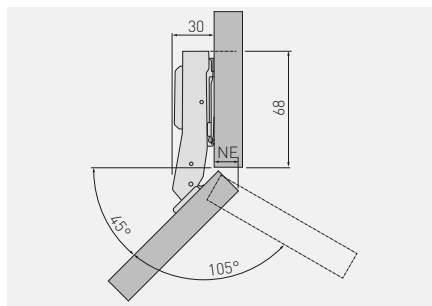

ZM-HCKT45-3DBE0-S	H = 0	x 4	—	nikiel nickel нیکель	stal steel сталь



*Produkt dostępny na indywidualne zamówienie / Available for special orders / Товар доступен под заказ

Zawias równoległy hydrauliczny HCKT
 Parallel hydraulic hinge HCKT
 Гидравлическая петля под фальшпанель HCKT

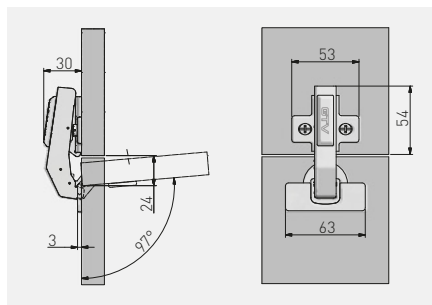

ZM-HCKT90-BE-S	H = 0	x 4	—	nikiel nickel	stal steel
ZM-HCKT90-ZE-S		x 2	x 2	никель	сталь



*Produkt dostępny na indywidualne zamówienie / Available for special orders / Товар доступен под заказ

Zawias równoległy HCKT z regulacją mimośrodową
 Parallel hinge HCKT with eccentric adjustment
 Петля под фальшпанель HCKT с эксцентриком

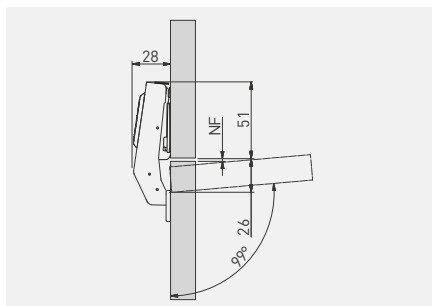
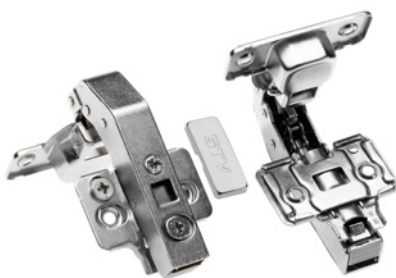

ZM-HCKT90-3DBE0-S	H = 0	x 4	—	nikiel nickel	stal steel



*Produkt dostępny na indywidualne zamówienie / Available for special orders / Товар доступен под заказ

Zawias z ujemnym uskokiem 155° hydrauliczny HCKT
 Hydraulic set-off hinge 155° HCKT
 Гидравлическая петля 155° HCKT

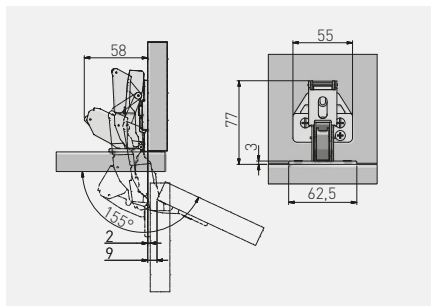

ZM-HCKT155BE	H = 0	—	—	nikiel nickel	stal, ZnAl steel, ZnAl
ZM-HCKT155ZE		—	x 2	никель	сталь, ZnAl



*Produkt dostępny na indywidualne zamówienie / Available for special orders / Товар доступен под заказ

Zawias 165° hydrauliczny HCKT
 Hydraulic hinge 165° HCKT
 Гидравлическая петля 165° HCKT

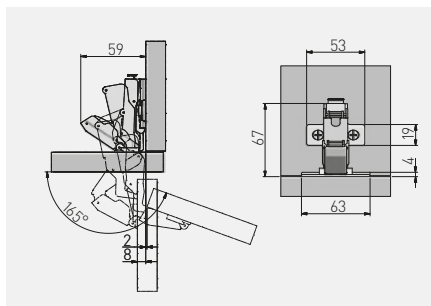

ZM-HCKT165BE-S	H = 0	—	—	nikiel nickel	stal steel
ZM-HCKT165ZE-S		—	x 2	никель	сталь



*Produkt dostępny na indywidualne zamówienie / Available for special orders / Товар доступен под заказ

Zawias 165° hydrauliczny HCKT z regulacją mimośrodową
 Hydraulic hinge 165° HCKT with eccentric adjustment
 Гидравлическая петля 165° HCKT с эксцентриком

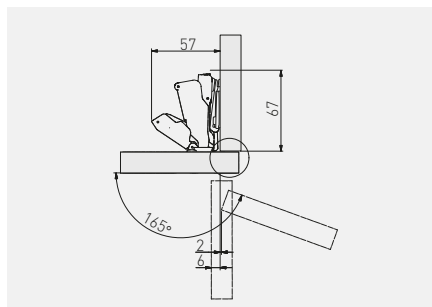

ZM-HCKT165-3DBEO-S	H = 0	—	—	nikiel nickel никель	stal steel сталь



*Produkt dostępny na indywidualne zamówienie / Available for special orders / Товар доступен под заказ

Zawias SOLID, nakładany
 Hinge SOLID, overlay door
 Петля SOLID, накладная

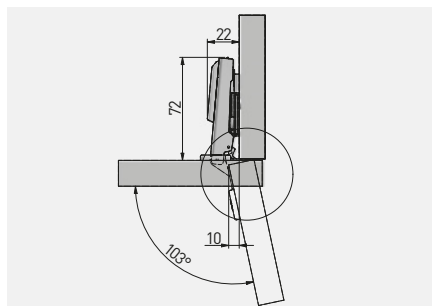

ZP-BIDI09-3DBEO	H = 0	—	—	nikiel nickel никель	stal steel сталь



*Produkt dostępny na indywidualne zamówienie / Available for special orders / Товар доступен под заказ

Zawias SOLID, bliźniaczy
Hinge SOLID, twin overlay door
Петля SOLID, полукладная

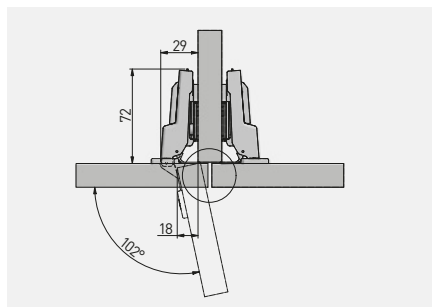

ZP-BIDI08-3DBEO	H = 0	—	—	nikiel nickel никель	stal steel сталь



*Produkt dostępny na indywidualne zamówienie / Available for special orders / Товар доступен под заказ

Zawias SOLID, wpuszczany
Hinge SOLID, inset door
Петля SOLID, внутренняя

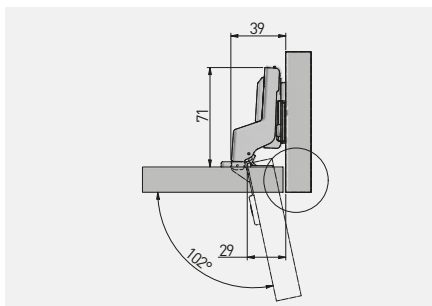

ZP-BIDI07-3DBEO	H = 0	—	—	nikiel nickel никель	stal steel сталь



*Produkt dostępny na indywidualne zamówienie / Available for special orders / Товар доступен под заказ

Zawias CONL, nakładany
Hinge CONL, overlay door
Петля CONL, накладная

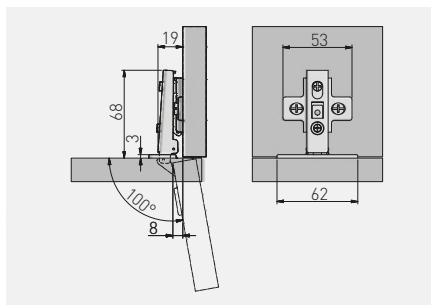

ZP-CONL09-BE	H = 0	—	—	nikiel nickel никель	stal steel сталь	
ZP-CONL09-ZE		—	x 2			



*Produkt dostępny na indywidualne zamówienie / Available for special orders / Товар доступен под заказ

Zawias CONL, bliźniaczy
Hinge CONL, twin overlay door
Петля CONL, полунакладная

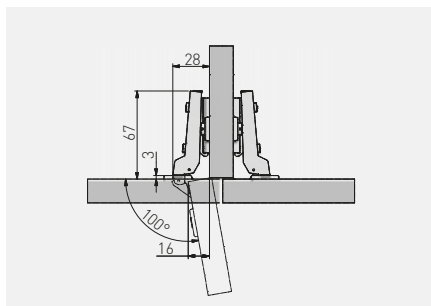

ZP-CONL08-BE	H = 0	—	—	nikiel nickel никель	stal steel сталь	
ZP-CONL08-ZE		—	x 2			



*Produkt dostępny na indywidualne zamówienie / Available for special orders / Товар доступен под заказ

Zawias CONL, wpuszczany
Hinge CONL, inset door
Петля CONL, внутренняя

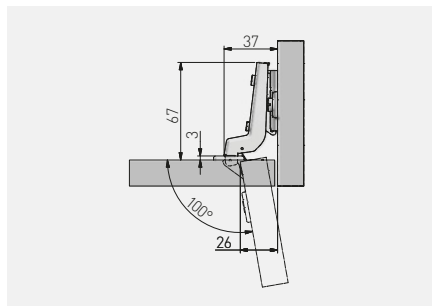

ZP-CONL07-BE	H = 0	—	—	nikiel nickel никель	stal steel сталь	
ZP-CONL07-ZE		—	x 2			



*Produkt dostępny na indywidualne zamówienie / Available for special orders / Товар доступен под заказ

Zawias BICN, nakładany
Hinge BICN, overlay door
Петля BICN, накладная

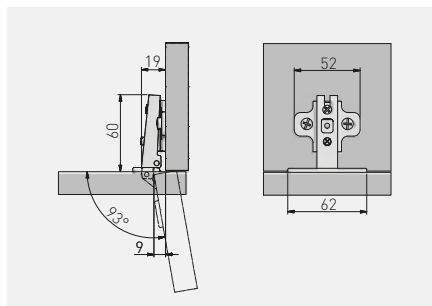

ZP-BICN090BE	H = 0	—	—	nikiel nickel никель	stal steel сталь	
ZP-BICN090ZE		—	x 2			
ZP-BICN092BE	H = 2	—	—			
ZP-BICN092ZE		—	x 2			



*Produkt dostępny na indywidualne zamówienie / Available for special orders / Товар доступен под заказ

Zawias BICN, bliźniaczy
Hinge BICN, twin overlay door
Петля BICN, полунакладная

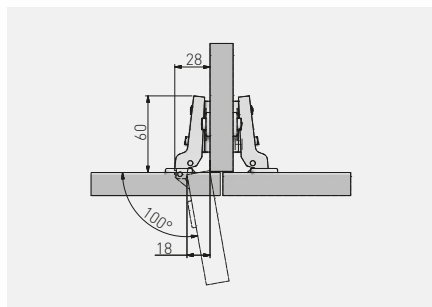

ZP-BICN080BE	H = 0	—	—	nikiel nickel никель	stal steel сталь	
ZP-BICN080ZE		—	x 2			
ZP-BICN082BE	H = 2	—	—	nikiel nickel никель	stal steel сталь	
ZP-BICN082ZE		—	x 2			



*Produkt dostępny na indywidualne zamówienie / Available for special orders / Товар доступен под заказ

Zawias BICN, wpuszczany
Hinge BICN, inset door
Петля BICN, внутренняя

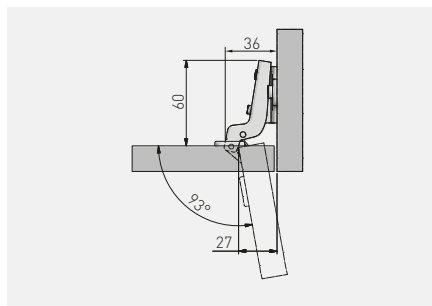

ZP-BICN070BE	H = 0	—	—	nikiel nickel никель	stal steel сталь	
ZP-BICN070ZE		—	x 2			
ZP-BICN072BE	H = 2	—	—	nikiel nickel никель	stal steel сталь	
ZP-BICN072ZE		—	x 2			



*Produkt dostępny na indywidualne zamówienie / Available for special orders / Товар доступен под заказ

Zawias kątowy 30° KT
 Corner hinge 30° KT
 Угловая петля 30° KT

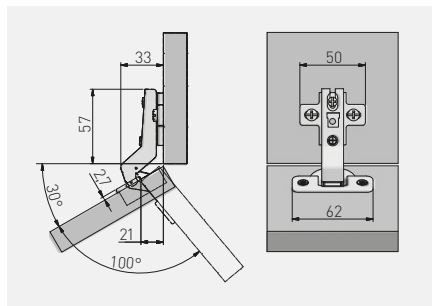

ZP-KT30H2-BE	H = 2	—	—	nikiel nickel никель	stal steel сталь



Zawias kątowy 45° KT
 Corner hinge 45° KT
 Угловая петля 45° KT

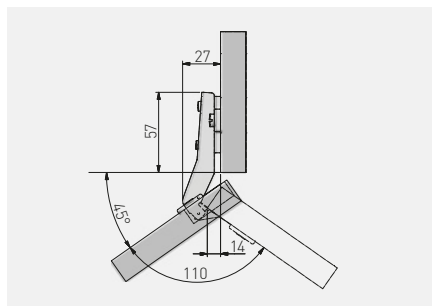

ZP-KT45H2-BE	H = 2	—	—	nikiel nickel никель	stal steel сталь
ZP-KT45H2-ZE		—	x 2	—	



Zawias 165° KT
Hinge 165° KT
Петля 165° KT

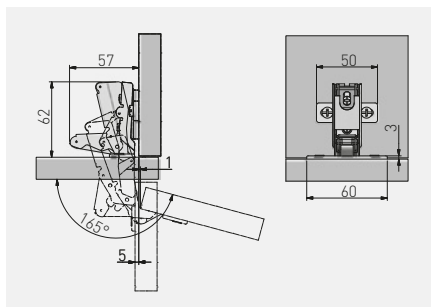

ZP-KT165H2BE	H = 2	—	—	nikiel nickel	stal steel
ZP-KT165H2ZE		—	x 2	nikiel nickel	stal steel



Zawias uzupełniający 135° KT
Complementary hinge 135° KT
Петля для складных дверей 135° KT

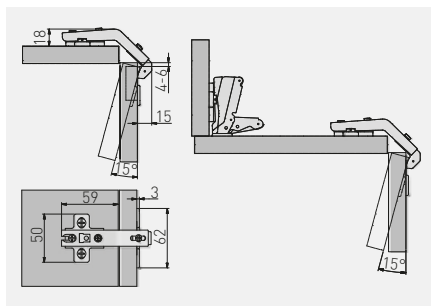

ZP-KT135H2BE	H = 2	—	—	nikiel nickel	stal, ZnAl steel, ZnAl
ZP-KT135H2ZE		—	x 2	nikiel nickel	stal, ZnAl steel, ZnAl



Zawias bez sprężyny COCA, nakładany
 Hinge without spring COCA, overlay door
 Петля без пружины СОСА, накладная

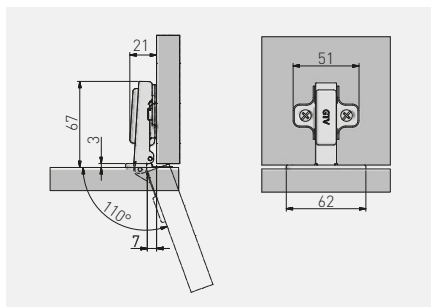

ZP-COCA450-BE	H = 0	—	—	nikiel nickel никель	stal steel сталь
ZP-COCA450-ZE		—	x 2		
ZP-COCA8450-BE		—	—		



Zawias bez sprężyny COCA, wpuszczany
 Hinge without spring COCA, inset door
 Петля без пружины СОСА, внутренняя

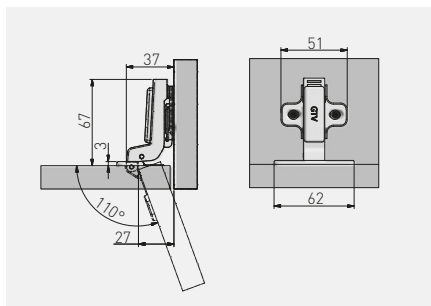

ZP-COCA7450-BE	H = 0	—	—	nikiel nickel никель	stal steel сталь



Zawias bez sprężyny COCA, nakładany
 Hinge without spring COCA, overlay door
 Петля без пружины СОСА, накладная

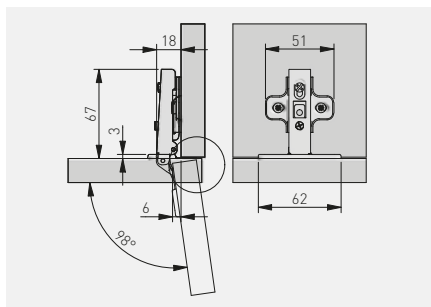

ZP-COCA450-BE-F	H = 0	—	—	nikiel nickel никель	stal steel сталь



Zawias bez sprężyny COCA, bliźniaczy
 Hinge without spring COCA, twin overlay door
 Петля без пружины СОСА, полунакладная

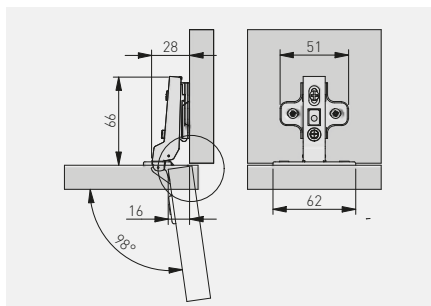

ZP-COCA8450-BE-F	H = 0	—	—	nikiel nickel никель	stal steel сталь



Zawias bez sprężyny COCA, wpuszczany
 Hinge without spring COCA, inset door
 Петля без пружины СОСА, внутренняя

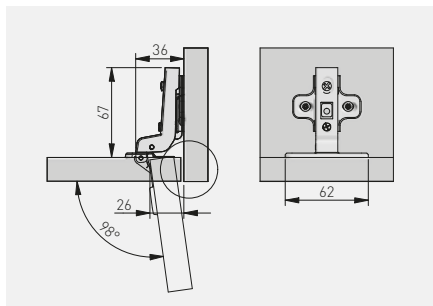

ZP-COCA7450-BE-F	H = 0	—	—	nikiel nickel ннкель	stal steel сталь
------------------	-------	---	---	----------------------------	------------------------



Zawias samootwierający PO, nakładany
 Self-opening hinge PO, overlay door
 Петля самооткрывающаяся PO, накладная

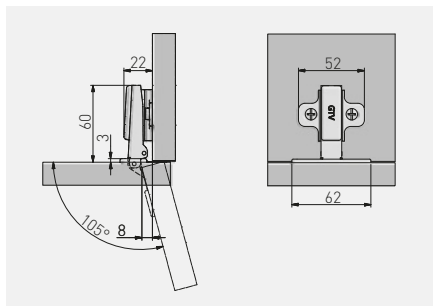

ZP-POH045BE0	H = 0	—	—	nikiel nickel никель	stal steel сталь
ZP-POH045ZE0		—	x 2		



Zawias samootwierający PO, wpuszczany
 Self-opening hinge PO, inset door
 Петля самооткрывающаяся PO, внутренняя

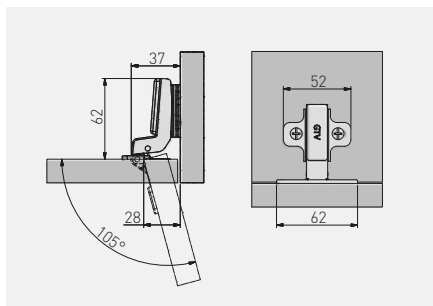

ZP-P07H045BE	H = 0	—	—	nikiel nickel никель	stal steel сталь



Zawias hydrauliczny mini CIHC, nakładany
 Hydraulic hinge mini CIHC, overlay door
 Гидравлическая петля мини CIHC, накладная

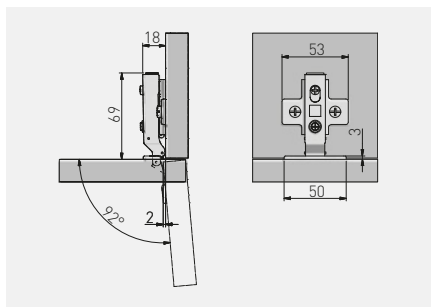

ZP-CIHC090ZE	H = 0	x 2	x 2	nikiel nickel нικель	stal, ZnAl steel, ZnAl сталь, ZnAl



Zawias hydrauliczny mini CIHC, bliźniaczy
 Hydraulic hinge mini CIHC, twin overlay door
 Гидравлическая петля мини CIHC, полунакладная

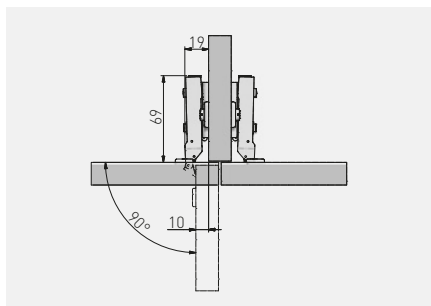

ZP-CIHC080ZE	H = 0	x 2	x 2	nikiel nickel нικель	stal, ZnAl steel, ZnAl сталь, ZnAl



Zawias hydrauliczny mini CIHC, wpuszczany
 Hydraulic hinge mini CIHC, inset door
 Гидравлическая петля мини CIHC, внутренняя

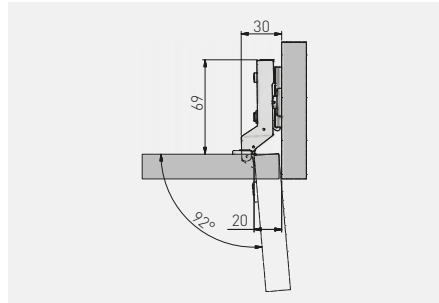

ZP-CIHC070ZE	H = 0	x 2	x 2	nikiel nickel нικель	stal, ZnAl steel, ZnAl сталь, ZnAl



Zawias mini CIBI, nakładany
 Hinge mini CIBI, overlay door
 Петля мини CIBI, накладная

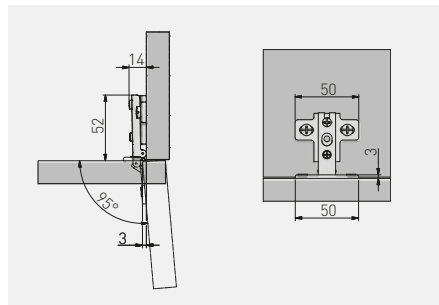

ZP-CIBI9H0ZE	H = 0	-	x 2	nikiel nickel нικель	stal steel сталь



Zawias mini CIBI, bliźniaczy
Hinge mini CIBI, twin overlay door
Петля мини CIBI, полунакладная

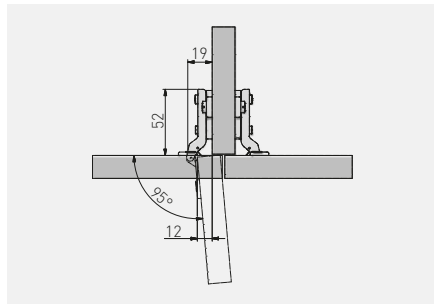

ZP-CIBI8H0ZE	H = 0	-	x 2	nikiel nickel никель	stal steel сталь



Zawias mini CIBI, wpuszczany
Hinge mini CIBI, inset door
Петля мини CIBI, внутренняя

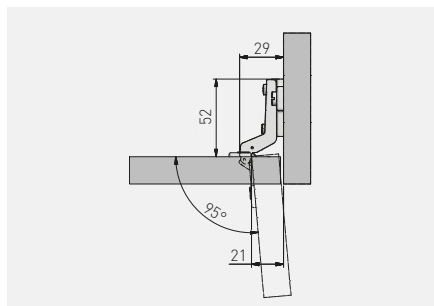

ZP-CIBI7H0ZE	H = 0	-	x 2	nikiel nickel никель	stal steel сталь



Zawias do szkła CIG, nakładany
 Hinge for glass CIG, overlay door
 Петля для стеклянных дверей CIG, накладная

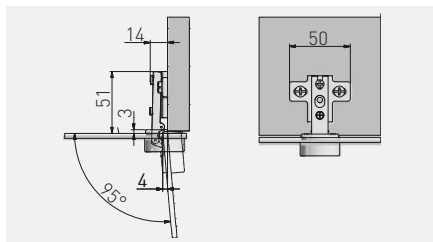

ZP-CIG-09OZE	H = 0	—	x 2	nikiel nickel нικель	stal, tworzywo steel, plastic сталь, пластмасса		chrom chrome хром	
ZP-CIG-09UZE		—	x 2					
ZP-CIG-09UBE		—	—				czarny / black / чёрный	
ZP-CIG-09UZC		—	x 2					
ZP-CIG-19OZE		—	x 2				aluminium aluminium алюминий	
ZP-CIG-19UZE		—	x 2					



Zawias do szkła CIG, wpuszczany
 Hinge for glass CIG, inset door
 Петля для стеклянных дверей CIG, внутренняя

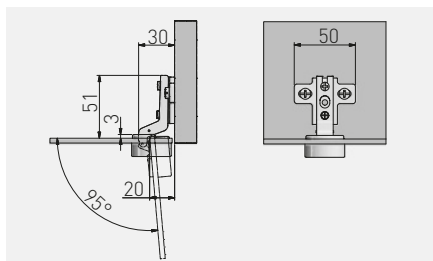

ZP-CIG-07OZE	H = 0	—	x 2	nikiel nickel нικель	stal, tworzywo steel, plastic сталь, пластмасса		chrom chrome хром	
ZP-CIG-07UZE		—	x 2					
ZP-CIG-17OZE		—	x 2				aluminium aluminium алюминий	
ZP-CIG-17UZE		—	x 2					



Zawias do ramek aluminiowych, nakładany
 Hinge for aluminium frames, overlay door
 Петля GTV для алюминиевых рамок, с клипом, накладная

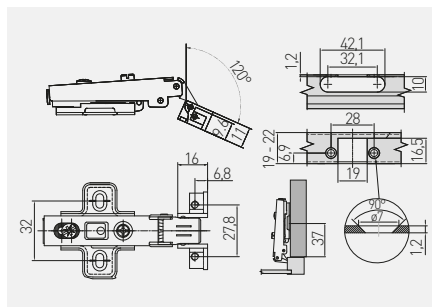

Produkt kompatybilny z profilem aluminiowym do frontów: PA-3731-35-50
 Product compatible with aluminum profile for fronts: PA-3731-35-50
 Подходит для алюминиевых профилей под индексом: PA-3731-35-50

ZP-RALUH2-00	H = 2	—	—	nikiel nickel никель	stal steel сталь



Zawias hydrauliczny do ramek aluminiowych, nakładany
 Hinge for aluminium frame, overlay door
 Петля GTV для алюминиевых рамок, с клипом, накладная

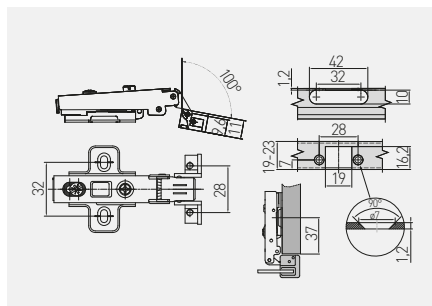

Produkt kompatybilny z profilem aluminiowym do frontów: PA-3731-35-50
 Product compatible with aluminum profile for fronts: PA-3731-35-50
 Подходит для алюминиевых профилей под индексом: PA-3731-35-50

ZM-HCRALU9BE	H = 0	—	—	nikiel nickel никель	stal steel сталь



Zawias 270°, nakładany
Hinge 270°, overlay door
Петля 270°, накладная

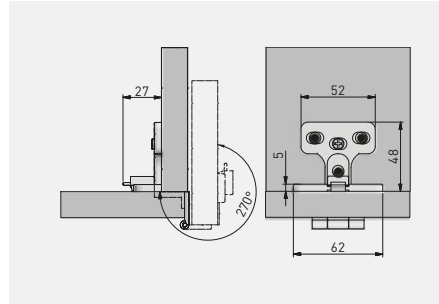

ZP-KT0270-BE	—	—	nikiel nickel никель	ZnAl



Zawias tłoczkowy duży
Cylinder hinge large
Поршневая петля (большая)

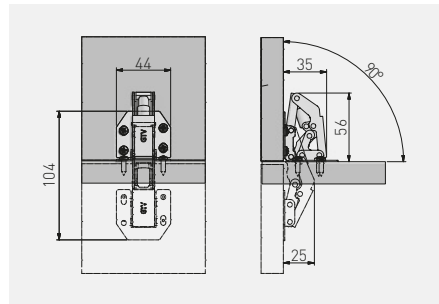





ZT-HF-01-D00	—	—	nikiel nickel никель	stal steel сталь

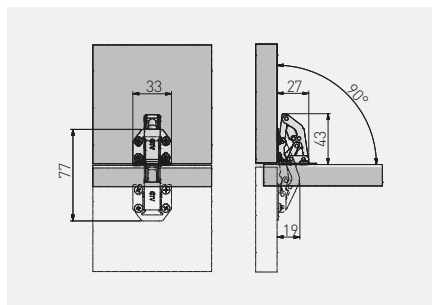

Zawias tłoczkowy mały
 Cylinder hinge small
 Поршневая петля (малая)







				
ZT-HF-01-M00	—	—	nikiel nickel никель	stal steel сталь

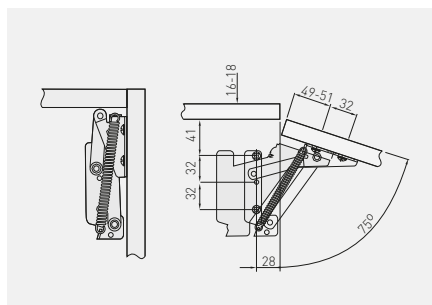

Zawias JUNIOR 75°
 JUNIOR hinge 75°
 Петля JUNIOR 75°



				
ZP-JUNIOR-00	—	—	nikiel nickel никель	stal steel сталь



Zawias skrzydełkowy
Butterfly hinge
Петля-бабочка

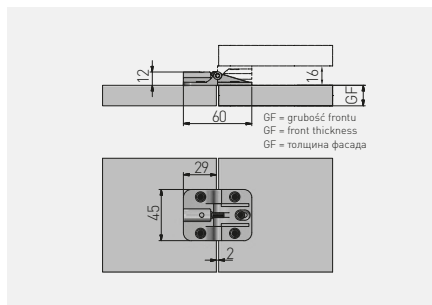

ZP-SKR-00-80	—	—	lakier lacquer лак	szary gray серый	ZnAl



Zawias cylindryczny
Cylinder hinge
Петля цилиндрическая

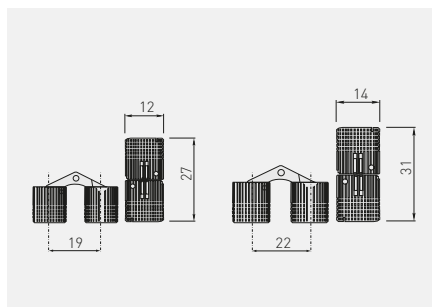

ZC-GTV-12-00	1 kpl. = 2 szt. 1 set = 2 pcs 1 компл. = 2 шт.	12	7	mosiądz brass латунь	mosiądz brass латунь
ZC-GTV-14-00		14			



Amortyzator z adapterem krzyżakowym
 Buffer with cross adapter
 Амортизатор с крестовым адаптером

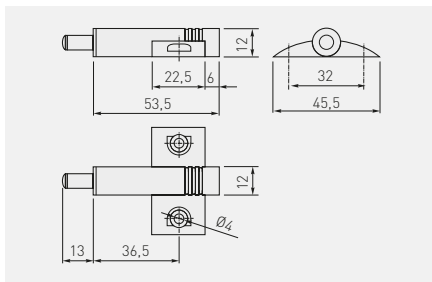

AM-KRZYZ-KPL	szary gray серый	tworzywo plastic пластмасса
--------------	------------------------	-----------------------------------



Amortyzator AM-ODB
 Buffer AM-ODB
 Амортизатор AM-ODB

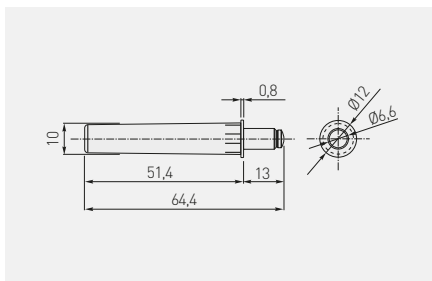

AM-ODB000-60	standard	szary / gray / серый	tworzywo / plastic / пластмасса
AM-ODB000-10		biały / white / белый	



Adapter AM-ODB prosty
 Adapter AM-ODB straight
 Адаптер AM-ODB прямой

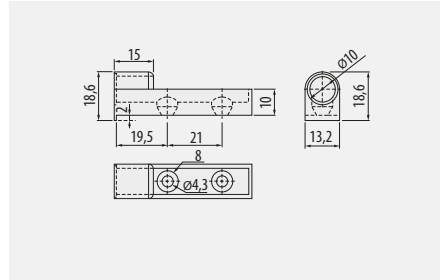
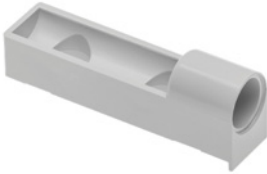

AM-ADAP0B-60	szary / gray / серый	tworzywo / plastic / пластмасса
AM-ADAP0B-10	biały / white / белый	



Adapter AM-ODB krzyżakowy
 Cross adapter AM-ODB
 Адаптер AM-ODB крестовой

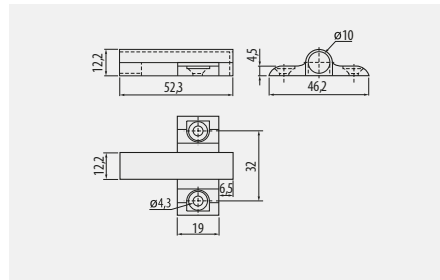

AM-ADAP0A-60	szary / gray / серый	tworzywo / plastic / пластмасса
AM-ADAP0A-10	biały / white / белый	



Odbojnik wpuszczany krótki
Bumper, recessed, short
Амортизатор врезной короткий

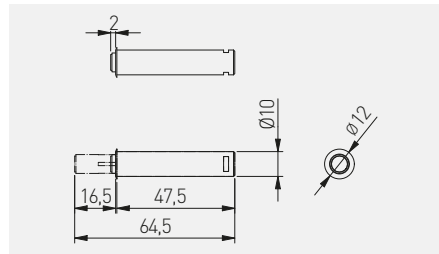

AM-OWM-KR-MG-10	z końcówką magnetyczną / magnetic tip / магнитный наконечник	biały white белый	tworzywo plastic пластмасса
AM-OWM-KR-GM-10	z końcówką kauczukową / with rubber tip / каучуковый наконечник		
AM-OWM-KR-MG-30	z końcówką magnetyczną / magnetic tip / магнитный наконечник	szary gray серый	
AM-OWM-KR-GM-30	z końcówką kauczukową / with rubber tip / каучуковый наконечник		
AM-OWM-KR-MG-60	z końcówką magnetyczną / magnetic tip / магнитный наконечник	antracyt anthracite антрацит	
AM-OWM-KR-GM-60	z końcówką kauczukową / with rubber tip / каучуковый наконечник		



Odbojnik wpuszczany długi
Bumper, recessed, long
Амортизатор врезной длинный

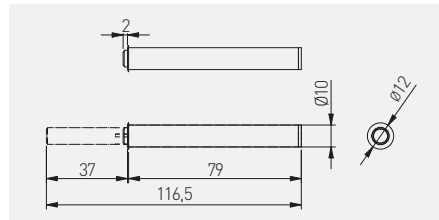

AM-OWM-DL-MG-10	z końcówką magnetyczną / magnetic tip / магнитный наконечник	biały white белый	tworzywo plastic пластмасса
AM-OWM-DL-GM-10	z końcówką kauczukową / with rubber tip / каучуковый наконечник		
AM-OWM-DL-MG-30	z końcówką magnetyczną / magnetic tip / магнитный наконечник	szary gray серый	
AM-OWM-DL-GM-30	z końcówką kauczukową / with rubber tip / каучуковый наконечник		
AM-OWM-DL-MG-60	z końcówką magnetyczną / magnetic tip / магнитный наконечник	antracyt anthracite антрацит	
AM-OWM-DL-GM-60	z końcówką kauczukową / with rubber tip / каучуковый наконечник		



Odbojnik AM-PL z adapterem
Bumper with adapter AM-PL
Амортизатор с адаптером AM-PL

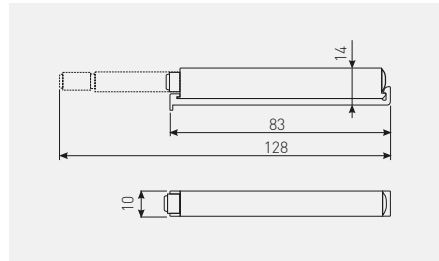

AM-PL-DL-MAG	z końcówką magnetyczną magnetic tip магнитный наконечник	szary gray серый	tworzywo plastic пластмасса
AM-PLA-DLU-0	z końcówką kauczukową with rubber tip каучуковый наконечник		



Odbojnik AM-PL z adapterem
Bumper with adapter AM-PL
Демпфер мебельный с адаптером AM-PL

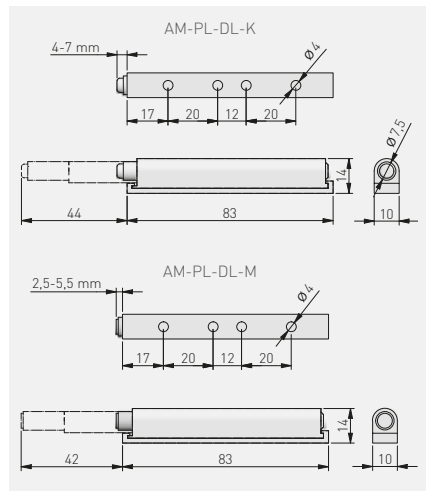

AM-PL-DL-M	z końcówką magnetyczną magnetic tip магнитный наконечник	szary gray серый	tworzywo plastic пластмасса
AM-PL-DL-K	z końcówką kauczukową with rubber tip каучуковый наконечник		



Odbojnik krótki z adapterem
Bumper, short, with adapter
Амортизатор короткий с адаптером

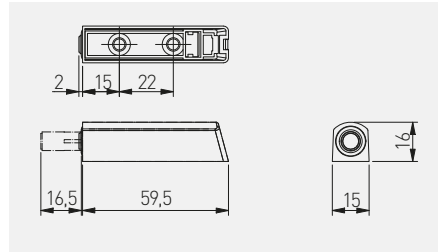

AM-OAM-KR-MG-10	z końcówką magnetyczną / magnetic tip / магнитный наконечник	biały white белый	tworzywo plastic пластмасса
AM-OAM-KR-GM-10	z końcówką kauczukową / with rubber tip / каучуковый наконечник		
AM-OAM-KR-MG-30	z końcówką magnetyczną / magnetic tip / магнитный наконечник	szary gray серый	
AM-OAM-KR-GM-30	z końcówką kauczukową / with rubber tip / каучуковый наконечник		
AM-OAM-KR-MG-60	z końcówką magnetyczną / magnetic tip / магнитный наконечник	antracyt anthracite антрацит	
AM-OAM-KR-GM-60	z końcówką kauczukową / with rubber tip / каучуковый наконечник		



Odbojnik długi z adapterem
Bumper, long, with adapter
Амортизатор длинный с адаптером

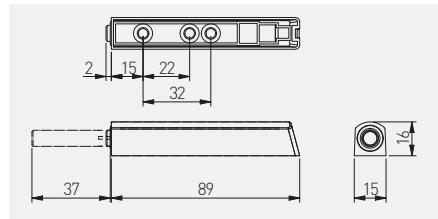

AM-OAM-DL-MG-10	z końcówką magnetyczną / magnetic tip / магнитный наконечник	biały white белый	tworzywo plastic пластмасса
AM-OAM-DL-GM-10	z końcówką kauczukową / with rubber tip / каучуковый наконечник		
AM-OAM-DL-MG-30	z końcówką magnetyczną / magnetic tip / магнитный наконечник	szary gray серый	
AM-OAM-DL-GM-30	z końcówką kauczukową / with rubber tip / каучуковый наконечник		
AM-OAM-DL-MG-60	z końcówką magnetyczną / magnetic tip / магнитный наконечник	antracyt anthracite антрацит	
AM-OAM-DL-GM-60	z końcówką kauczukową / with rubber tip / каучуковый наконечник		



Odbojnik AM-ZAT zatraskowy
Push latch AM-ZAT
Амортизатор AM-ZAT на защелке

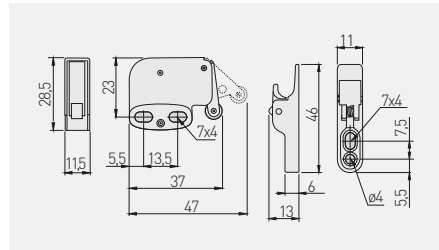

		
AM-ZAT-A1-10	biały white белый	stal, tworzywo steel, plastic сталь, пластмасса





Do zastosowania z zawiasem
samootwierającym ZP-POH045ZE0
Dedicated for GTV self opening
hinge ZP-POH045ZE0

Используется с самооткрывающейся
петлей ZP-POH045ZE0

Amortyzator silikonowy
Silicone damper dots
Амортизатор силиконовый





		
AMR-BP-1003	Ø10 x 3	100 szt. / arkusz 100 pcs / sheet 100 шт. / лист
AMR-BP-0715	Ø7 x 1,5	



Podnośnik PD-LIFTNEW
PD-LIFTNEW lift
Подъемник PD-LIFTNEW



	Orientacyjna wysokość frontu Approximate front height Ориентировочная высота фасада	Współczynnik F Power Factor F Показатель F	Sprężyna Spring power Пружина		
PD-LIFTNEW-LIGHT-10	250 – 400 mm	480 – 1250	light	biały / white / белый	stal steel сталь
PD-LIFTNEW-LIGHT-80				szary / gray / серый	
PD-LIFTNEW-MEDIUM-10	250 – 500 mm	960 – 2350	medium	biały / white / белый	
PD-LIFTNEW-MEDIUM-80				szary / gray / серый	
PD-LIFTNEW-STRONG-10	250 – 500 mm	1600 – 3600	strong	biały / white / белый	
PD-LIFTNEW-STRONG-80				szary / gray / серый	
PD-LIFTNEW-STRONG-PLUS-10	600 mm	2500 – 4500	extra strong	biały / white / белый	
PD-LIFTNEW-STRONG-PLUS-80				szary / gray / серый	

Współczynnik mocy F = wysokość frontu H (mm) × waga frontu łącznie z podwójną wagą uchwytu (kg)

Power Factor F = front height × front weight with doubled handle weight (kg)

Показатель мощности F = высота фасада H (мм) × вес фасада с удвоенным весом ручки (кг)

Podnośnik PD-LIFT-P20
PD-LIFT-P20 lift
Подъемник PD-LIFT-P20



	Orientacyjna wysokość frontu Approximate front height Ориентировочная высота фасада	Współczynnik F Power Factor F Показатель F	Sprężyna Spring power Пружина		
PD-LIFT-P20-LIGHT-10	250 – 400 mm	580 – 1350	light	biały / white / белый	stal steel сталь
PD-LIFT-P20-LIGHT-80				szary / gray / серый	
PD-LIFT-P20-MEDIUM-10	250 – 500 mm	1060 – 2450	medium	biały / white / белый	
PD-LIFT-P20-MEDIUM-80				szary / gray / серый	
PD-LIFT-P20-STRONG-10	250 – 500 mm	1800 – 4000	strong	biały / white / белый	
PD-LIFT-P20-STRONG-80				szary / gray / серый	
PD-LIFT-P20-STRONG-PLUS-10	600 mm	2600 – 5000	extra strong	biały / white / белый	
PD-LIFT-P20-STRONG-PLUS-80				szary / gray / серый	

Współczynnik mocy F = wysokość frontu H (mm) × waga frontu łącznie z podwójną wagą uchwytu (kg)

Power Factor F = front height H (mm) × front weight with doubled handle weight (kg)

Показатель мощности F = высота фасада H (мм) × вес фасада с удвоенным весом ручки (кг)

Podnośnik PD-MINILIFTNEW
 PD-MINILIFTNEW lift
 Подъемник PD-MINILIFTNEW

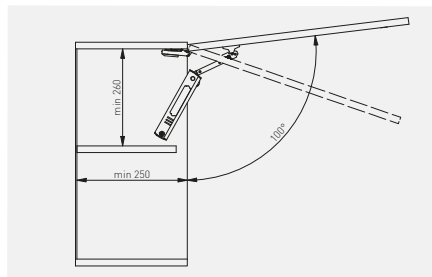

	Wymiary frontu Front dimensions Размеры фасада		Waga frontu Front weight Вес фасада	Zalecana ilość podnośników (szt.) Recommended number of lifts Рекомендуемое количество подъемников (шт.)		
	Wysokość Height Высота	Szerokość Width Ширина				
PD-MINILIFTNEW-LIGHT	300-400 mm	500-800 mm	2-3 kg	1	chrom / chrome / хром	stal steel сталь
PD-MINILIFTNEW-LIGHT-20	300-400 mm	500-1000 mm	3,1-4 kg	2	czarny / black / черный	
PD-MINILIFTNEW-MEDIUM	300-450 mm	500-1000 mm	3,5-4,5 kg	1	chrom / chrome / хром	
PD-MINILIFTNEW-MEDIUM-20	300-450 mm	500-1200 mm	5,5-7,5 kg	2	czarny / black / черный	
PD-MINILIFTNEW-STRONG	380-550 mm	500-1200 mm	5-6 kg	1	chrom / chrome / хром	
PD-MINILIFTNEW-STRONG-20	380-550 mm	500-1200 mm	6,5-10 kg	2	czarny / black / черный	



Podnośnik gazowy NEO
Gas stay lift NEO
Подъемник газовый NEO

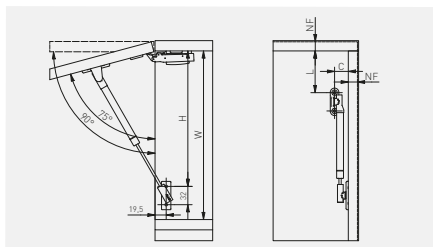

ø 12				
Kąt otwarcia drzwi Door opening angle Угол открывания дверей	H (mm)	L (mm)	C (mm)	W (mm)
75°	237	73	24	275
90°	217	54		
ø 15				
Kąt otwarcia drzwi Door opening angle Угол открывания дверей	H (mm)	L (mm)	C (mm)	W (mm)
75°	247	73	24	295
90°	228	52		

Model	Lift force (N)	Color	Material
PD-GNE012-50-60	50 N	szary / antracyt gray / anthracite серый / антрацит	stal steel сталь
PD-GNE012-60-60	60 N		
PD-GNE012-80-60	80 N		
PD-GNE012-50-10M	50 N	biały white белый	
PD-GNE012-60-10M	60 N		
PD-GNE012-80-10M	80 N		

Kąt otwarcia drzwi Door opening angle Угол открывания дверей	Siła podnośnika Lift force Мощность подъемника	Wysokość drzwi (mm) / Door height (mm) / Высота дверцы (мм)			
		300	400	500	600
		Waga drzwi (kg) / Door weight (kg) / Вес дверцы (кг)			
75°	50 N	1,6	1,2	1,0	0,8
	60 N	2,0	1,5	1,2	1,0
	80 N	2,7	2,0	1,6	1,4
	100 N	3,4	2,6	2,0	1,7
	120 N	4,1	3,1	2,5	2,0
90°	150 N	4,7	3,5	2,9	2,4
	50 N	1,5	1,1	0,9	0,7
	60 N	1,8	1,3	1,1	0,9
	80 N	2,4	1,8	1,4	1,2
	100 N	3,0	2,2	1,8	1,5
100°	120 N	3,6	2,7	2,1	1,8
	150 N	4,1	3,2	2,3	2,1
	50 N	1,1	1,0	0,8	0,7
	60 N	1,6	1,2	0,9	0,8
	80 N	2,1	1,6	1,2	1,0
100°	100 N	2,6	1,9	1,6	1,3
	120 N	3,1	2,3	1,9	1,6
	150 N	3,5	2,6	2,2	1,9

Podnośnik gazowy z amortyzatorem i regulacją

Gas stay with buffer, adjustable

Подъемник газовый с амортизатором и регулировкой

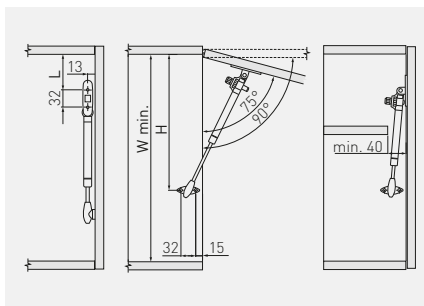

PD-GAM050-N02	50 N	szary gray серый	stal steel сталь
PD-GAM060-N02	60 N		
PD-GAM080-N02	80 N		
PD-GAM100-N02	100 N		
PD-GAM120-N02	120 N		
PD-GAM050-N10	50 N	biały white белый	
PD-GAM060-N10	60 N		
PD-GAM080-N10	80 N		
PD-GAM100-N10	100 N		
PD-GAM120-N10	120 N		
PD-GAM150-N10	150 N	antracyt anthracite антрацит	
PD-GAM050-N60	50 N		
PD-GAM060-N60	60 N		
PD-GAM080-N60	80 N		
PD-GAM100-N60	100 N		
PD-GAM120-N60	120 N		
PD-GAM150-N60	150 N		

Kąt otwarcia drzwi Door opening angle Угол открывания дверей	H (mm)	L (mm)	W (mm)
75°	295	64	315
90°	275	52	300



Kąt otwarcia drzwi Door opening angle Угол открывания дверей	Siła podnośnika Lift force Мощность подъемника	Wysokość drzwi (mm) / Door height (mm) / Высота дверцы (мм)			
		300	400	500	600
		Waga drzwi (kg) / Door weight (kg) / Вес дверцы (кг)			
 75°	50 N	1,6	1,2	1,0	0,8
	60 N	2,0	1,5	1,2	1,0
	80 N	2,7	2,0	1,6	1,4
	100 N	3,4	2,6	2,0	1,7
	120 N	4,1	3,1	2,5	2,0
 90°	50 N	1,5	1,1	0,9	0,7
	60 N	1,8	1,3	1,1	0,9
	80 N	2,4	1,8	1,4	1,2
	100 N	3,0	2,2	1,8	1,5
	120 N	3,6	2,7	2,1	1,8
	150 N	4,1	3,2	2,3	2,1

Podnośnik gazowy standard
Gas stay lift standard
Подъемник газовый стандартный

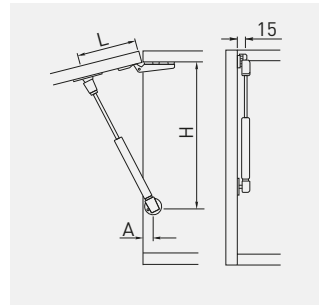

PD-G0050-N02	50 N	szary gray серый	stal steel сталь
PD-G0060-N02	60 N		
PD-G0080-N02	80 N		
PD-G0100-N02	100 N		
PD-G0120-N02	120 N		
PD-G0150-N02	150 N		



Kąt otwarcia drzwi Door opening angle Угол открывания дверей	Drzwi wpuszczane Inset door Внутренние дверцы			Drzwi bliźniacze Twin door Двойные дверцы			Drzwi nakładane Overlay door Наружные дверцы		
	H (mm)	L (mm)	A (mm)	H (mm)	L (mm)	A (mm)	H (mm)	L (mm)	A (mm)
75°	280	100	20 + grubość frontu 20 + front thickness 20 + толщина фронта	272	100	25	264	100	25
90°	260	90		251	90	25	244	90	25
100°	250	80		242	80	25	234	80	25

Kąt otwarcia drzwi Door opening angle Угол открывания дверей	Siła podnośnika Lift force Мощность подъемника	Wysokość drzwi (mm) / Door height (mm) / Высота дверцы (мм)			
		300	400	500	600
		Waga drzwi (kg) / Door weight (kg) / Вес дверцы (кг)			
 75°	60 N	2,0	1,5	1,2	1,0
	80 N	2,7	2,0	1,6	1,4
	100 N	3,4	2,6	2,0	1,7
	120 N	4,1	3,1	2,5	2,0
	150 N	4,7	3,5	2,9	2,4
 90°	60 N	1,8	1,3	1,1	0,9
	80 N	2,4	1,8	1,4	1,2
	100 N	3,0	2,2	1,8	1,5
	120 N	3,6	2,7	2,1	1,8
	150 N	4,1	3,2	2,3	2,1
 100°	60 N	1,6	1,2	0,9	0,8
	80 N	2,1	1,6	1,2	1,0
	100 N	2,6	1,9	1,6	1,3
	120 N	3,1	2,3	1,9	1,6
	150 N	3,5	2,6	2,2	1,9

Podnośnik gazowy standard
 Gas stay lift standard
 Подъемник газовый стандартный



PD-G0050-N03	50 N	szary gray серый	stal steel сталь
PD-G0060-N03	60 N		
PD-G0080-N03	80 N		
PD-G0100-N03	100 N		
PD-G0120-N03	120 N		
PD-G0150-N03	150 N		

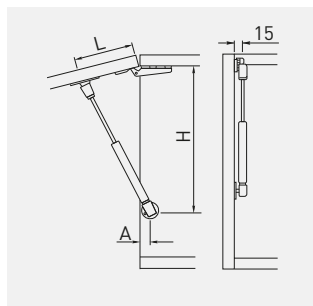

Kąt otwarcia drzwi Door opening angle Угол открывания дверей	Drzwi nakładane Overlay door Наружные двери		
	H (mm)	L (mm)	A (mm)
75°	280	72	12
90°	237	60	
100°	228	52	

Kąt otwarcia drzwi Door opening angle Угол открывания дверей	Siła podnośnika Lift force Мощность подъемника	Wysokość drzwi (mm) / Door height (mm) / Высота двери (мм)			
		300	400	500	600
		Waga drzwi (kg) / Door weight (kg) / Вес двери (кг)			
75°	50 N	1,6	1,2	1,0	0,8
	60 N	2,0	1,5	1,2	1,0
	80 N	2,7	2,0	1,6	1,4
	100 N	3,4	2,6	2,0	1,7
	120 N	4,1	3,1	2,5	2,0
	150 N	4,7	3,5	2,9	2,4
90°	50 N	1,5	1,1	0,9	0,7
	60 N	1,8	1,3	1,1	0,9
	80 N	2,4	1,8	1,4	1,2
	100 N	3,0	2,2	1,8	1,5
	120 N	3,6	2,7	2,1	1,8
	150 N	4,1	3,2	2,3	2,1
100°	50 N	1,1	1,0	0,8	0,7
	60 N	1,6	1,2	0,9	0,8
	80 N	2,1	1,6	1,2	1,0
	100 N	2,6	1,9	1,6	1,3
	120 N	3,1	2,3	1,9	1,6
	150 N	3,5	2,6	2,2	1,9

Podnośnik gazowy krótki
Gas stay lift short
Подъемник газовый короткий

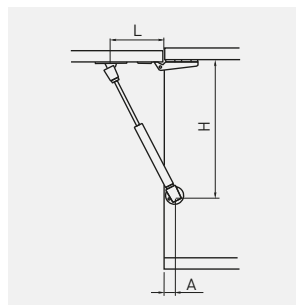

PD-G60160-02	60 N	szary gray серый	stal steel сталь
PD-G80160-02	80 N		



Kąt otwarcia drzwi Door opening angle Угол открывания дверей	Drzwi wpuszczane Inset door Внутренние дверцы			Drzwi bliźniacze Twin door Двойные дверцы			Drzwi nakładane Overlay door Наружные дверцы		
	H (mm)	L (mm)	A (mm)	H (mm)	L (mm)	A (mm)	H (mm)	L (mm)	A (mm)
75°	188	70	20 + grubość frontu 20 + front thickness 20 + толщина фронта	180	70	20	172	70	20
90°	176	60		167	60	20	160	60	20
100°	172	50		164	50	20	154	50	20

Kąt otwarcia drzwi Door opening angle Угол открывания дверей	Siła podnośnika Lift force Мощность подъемника	Wysokość drzwi (mm) / Door height (mm) / Высота дверцы (мм)			
		300	400	500	600
		Waga drzwi (kg) / Door weight (kg) / Вес дверцы (кг)			
75° 	60 N	2,0	1,5	1,2	1,0
	80 N	2,7	2,0	1,6	1,4
90° 	60 N	1,8	1,3	1,1	0,9
	80 N	2,4	1,8	1,4	1,2
100° 	60 N	1,6	1,2	0,9	0,8
	80 N	2,1	1,6	1,2	1,0

Podnośnik DESIGN mechaniczny
Mechanical stay lift DESIGN
Подъемник механический DESIGN



PD-GPD01-001	chrom / chrome / хром	stal steel сталь
PD-GPD02-002	satyna / satin / сатин	
PD-GPD03-005	aluminium / алюминий	



Podnośnik do klap
Flap lift
Подъемник фасада



100°

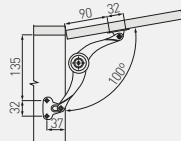

Płaszczyzna wewn. boku
Inner side surface
Поверхность боковой стенки

Podnośnik do klap
Flap lift
Подъемник фасада



75°

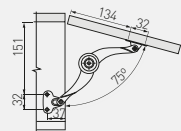

Płaszczyzna wewn. boku
Inner side surface
Поверхность боковой стенки

Podnośnik do klap
Flap lift
Подъемник фасада



90°

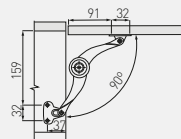

Płaszczyzna wewn. boku
Inner side surface
Поверхность боковой стенки

Wizualizacja dla zawiasów barkowych
Drop Down Flap Stay
Визуализация для барных петель



90°

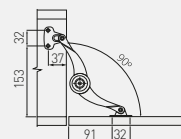

Płaszczyzna wewn. boku
Inner side surface
Поверхность боковой стенки

Wykres orientacyjnych wartości
maksymalnego ciężaru w zależności
od wysokości klap.

Maximum weight depending
on the flap height.

Максимальный вес фасада зависит
от его высоты.

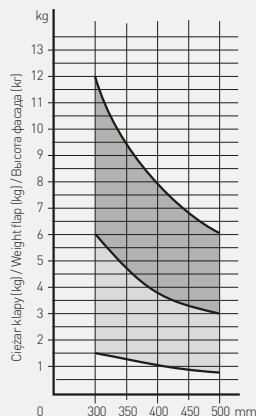
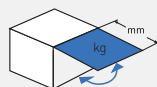

Wysokość kłapy (mm)
Flap height (mm)
Высота фасада (mm)

- 1 podnośnik
1 stay lift
1 подъемник
- 2 podnośniki
2 stay lifts
2 подъемника

Podnośnik mechaniczny standard
 Mechanical stay lift standard
 Подъемник механический стандартный



		
PD-PD000-001	chrom / chrome / хром	stal / steel / сталь



Podnośnik do klap
 Flap lift
 Поддержка фасада



100°

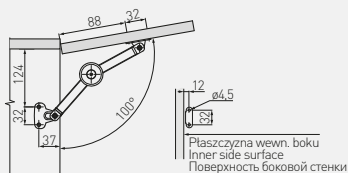

Wykres orientacyjnych wartości maksymalnego ciężaru w zależności od wysokości kłapy.

Maximum weight depending on the flap height.

Максимальный вес фасада зависит от его высоты.

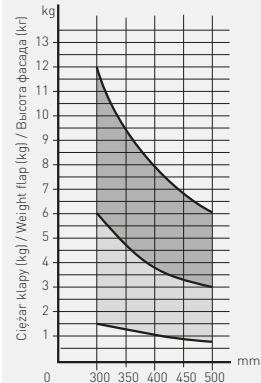
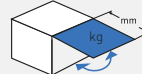

Podnośnik do klap
 Flap lift
 Поддержка фасада



75°

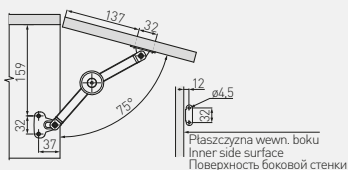

Podnośnik do klap
 Flap lift
 Поддержка фасада



90°

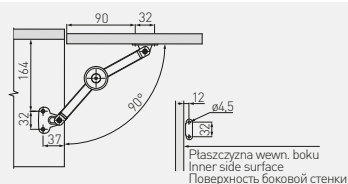



Rozwórka do klap
 Wizualizacja dla zawiasu barkowego
 Drop down flap stay
 Поддержка фасада
 Визуализация для барных петель

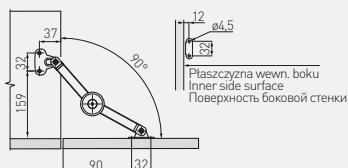

90°



Wysokość kłapy [mm]
 Flap height (mm)
 Высота фасада (мм)

-  1 podnośnik / 1 stay lift / 1 подъемник
-  2 podnośniki / 2 stay lifts / 2 подъемника

Podnośnik mechaniczny standard
 Mechanical stay lift standard
 Подъемник механический стандартный



PD-PD000-001B



chrom / chrome / хром



stal / steel / сталь



Podnośnik do klap
 Flap lift
 Поддержка фасада



100°

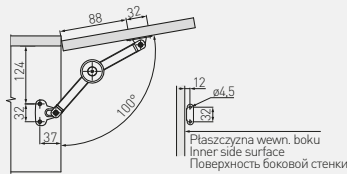

Wykres orientacyjnych wartości maksymalnego ciężaru w zależności od wysokości kłapy.

Maximum weight depending on the flap height.

Максимальный вес фасада зависит от его высоты.

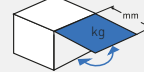

Podnośnik do klap
 Flap lift
 Поддержка фасада



75°

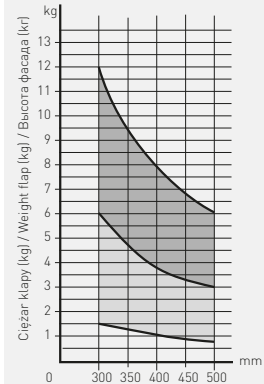
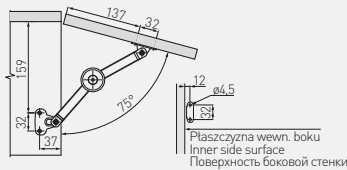

Podnośnik do klap
 Flap lift
 Поддержка фасада



90°

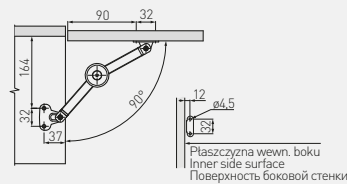

Rozwórka do klap
 Wizualizacja dla zawiasu barkowego
 Drop down flap stay
 Поддержка фасада
 Визуализация для барных петель



90°

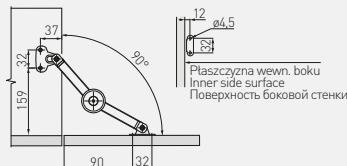

Wysokość kłapy (mm)
 Flap height (mm)
 Высота фасада (мм)

- 1 podnośnik
1 stay lift
1 подъемник
- 2 podnośniki
2 stay lifts
2 подъемника

Amortyzator VIM do klap barkowych, krótki
 VIM stay lift for drop down cabinet doors, short
 Амортизатор барный, короткий VIM



Produkt kompatybilny z zawiasem barkowym: PD-MD-ZB
 Compatible with flap hinge: PD-MD-ZB
 Продукт совместим с барной петлей: PD-MD-ZB

PD-MDLIFT-P1-D	szary gray серый	stal steel сталь



Orientacyjna tabela wartości doboru podnośników, w zależności od szerokości i wysokości kłapy.
 Maximum weight depending on the flap width and height.

Таблица подбора амортизатора в зависимости от ширины и высоты фасада.

Wysokość Height Высота	Szerokość (mm) / Width (mm) / Ширина (мм)			
	600 mm	700 mm	800 mm	900 mm
Ilość amortyzatorów Number of lifts Количество амортизаторов				
250 mm	1	1	2	2
260 mm				
270 mm				
280 mm				
290 mm				
300 mm	2			
310 mm				
320 mm				
330 mm				
340 mm				
340 mm				

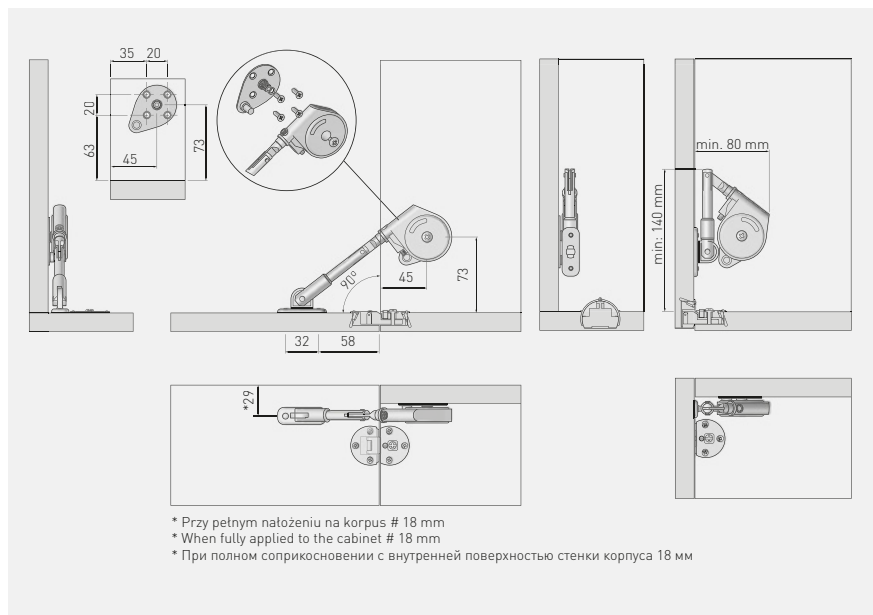

Amortyzator VIM do klap barkowych, długi
 VIM stay lift for drop down cabinet doors, long
 Амортизатор барный VIM, длинный



Produkt kompatybilny z zawiasem barkowym: PD-MD-ZB
 Compatible with flap hinge: PD-MD-ZB
 Продукт совместим с барной петлей: PD-MD-ZB

Orientacyjna tabela wartości doboru podnośników, w zależności od szerokości i wysokości kłapy.
 Maximum weight depending on the flap width and height.

Таблица подбора амортизатора в зависимости от ширины и высоты фасада.

		
PD-MDLIFT-P2-D	szary gray серый	stal steel сталь



Wysokość Height Высота	Szerokość (mm) / Width (mm) / Ширина (мм)			
	600 mm	700 mm	800 mm	900 mm
	Ilość amortyzatorów Number of lifts Количество амортизаторов			
350 mm				
360 mm				
370 mm				
380 mm	1	2	2	2
390 mm				
400 mm				

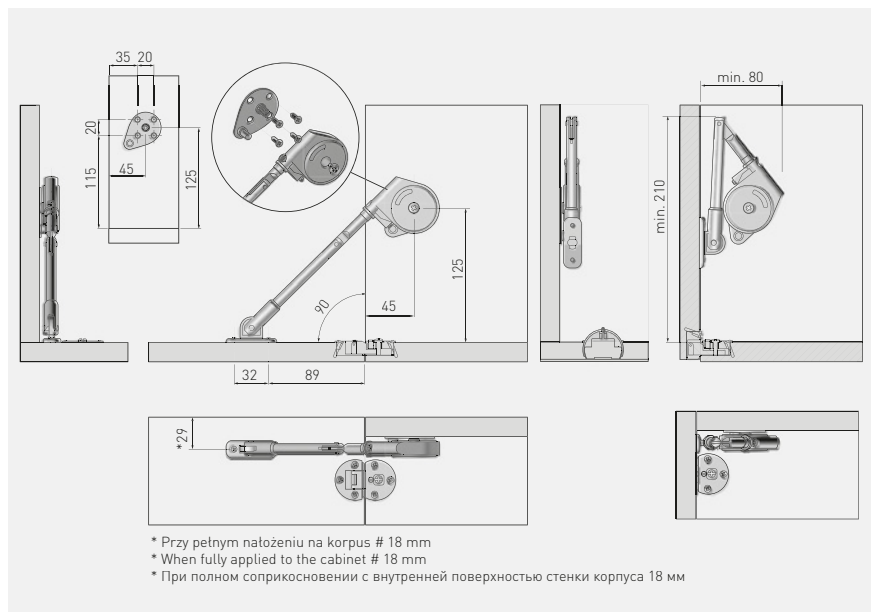

Amortyzator olejowy do klap barkowych
 Oil stay lift for drop down cabinet doors
 Амортизатор маслянный барный

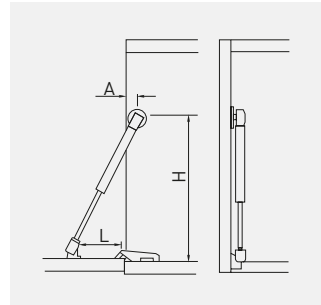

PD-ECGDL-060	60 N	szary gray серый	stal steel сталь
PD-ECGDL-080	80 N		
PD-ECGDL-150	150 N		



Kat otwarcia drzwi Door opening angle Угол открывания дверей	Drzwi wpuszczane Inset door Внутренние дверцы			Drzwi bliźniacze Twin door Двойные дверцы			Drzwi nakładane Overlay door Наружные дверцы		
	H (mm)	L (mm)	A (mm)	H (mm)	L (mm)	A (mm)	H (mm)	L (mm)	A (mm)
90°	260	90	45	253	90	25	246	90	25

Kat otwarcia drzwi Door opening angle Угол открывания дверей	Siła podnośnika Lift force Мощность подъемника	Wysokość drzwi (mm) / Door height (mm) / Высота дверцы (мм)			
		300	400	500	600
		Waga drzwi (kg) / Door weight (kg) / Вес дверцы (кг)			
 90°	60 N	1,8	1,3	1,1	0,9
	80 N	2,4	1,8	1,4	1,2
	150 N	4,1	3,2	2,3	2,1

Rozwórka
Stay
Барный кронштейн

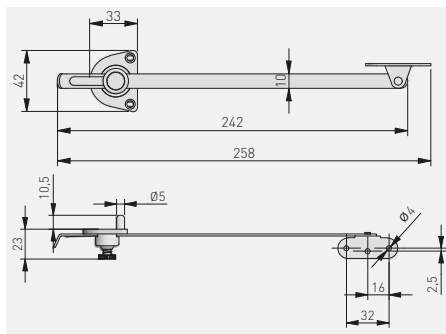

	INFO		
MR-SPG-UNI-GAL*	Rozwórka samohamująca uniwersalna galwanizowana Universal self-locking galvanized stay Барный кронштейн самоблокирующий универсальный оцинкованный	szary gray серый	stal, tworzywo steel, plastic сталь, пластмасса
MR-SPG-UNI-OC	Rozwórka samohamująca uniwersalna cynkowa Universal self-locking galvanized stay Барный кронштейн самоблокирующий универсальный оцинкованный		



*Produkt dostępny na indywidualne zamówienie / Available for special orders / Товар доступен под заказ

Wysokość kłapy (mm) Flap height (mm) Высота фасада (мм)	Szerokość kłapy (mm) Flap width (mm) Ширина фасада (мм)							
	300	400	500	600	700	800	900	1000
320	1,1	1,5	1,9	2,1	2,6	2,9	3,3	3,6
350	1,2	1,6	2,0	2,5	2,9	3,3	3,7	4,0
400	1,4	1,8	2,3	2,8	3,3	3,7	4,2	4,6
450	1,6	2,1	2,6	3,1	3,7	4,2	4,7	5,3
500	1,8	2,3	2,9	3,5	4,1	4,7	5,3	5,8
550	1,9	2,6	3,2	3,9	4,5	5,1	5,8	6,4
600	2,1	2,8	3,5	4,2	4,9	5,6	6,3	7,0

Ciężar kłapy w kg (płyta wiórowa: grubość = 18 mm, gęstość = 650 kg/m³)
Flap weight in kg (chipboard: thickness = 18 mm, density = 650 kg/m³)
Вес фасада в кг (ДСП: толщина = 18 мм, плотность = 650 кг / м³)

*przy szerszych kłapkach - sugerowane 2 rozwórki

*with wider flaps - suggested 2

*для более широких фасадов рекомендуется 2 барные кронштейна

Prowadnice dolnego montażu Modern Slide Pro
 Undermount drawer slide Modern Slide Pro
 Направляющая нижнего монтажа Modern Slide Pro



krawędź szafki / cabinet edge / край шкафа

1. prowadnica lewa/prawa
drawer slide L/R
направляющая Л/П
2. sprzęgło lewe/prawe + wkręty
locking device L/R + screws
крепления фасада Л/П + саморезы

NL = długość nominalna prowadnicy
nominal slide length
номинальная длина направляющей

AV = strata wysuwu
extension loss
потеря на выдвигении

Uwagi montażowe: dla prawidłowego działania szuflady jej szerokość nie może przekraczać długości nominalnej prowadnicy.
 Mounting information: for proper drawer operation, the width of the drawer can not exceed the nominal slide length.
 Техническое примечание: ширина ящика не должна превышать длину направляющей.

	L mm	AV mm		kg +		
PB-3D0SHX18-250-PRO	250	30	pełny full полное	35	ocynk galvanized гальваника	stal steel сталь
PB-3D0SHX18-300-PRO	300	30				
PB-3D0SHX18-350-PRO	350	30				
PB-3D0SHX18-400-PRO	400	30				
PB-3D0SHX18-450-PRO	450	30				
PB-3D0SHX18-500-PRO	500	30				
PB-3D0SHX18-550-PRO	550	30				
PB-3D0SHX18-600-PRO	600	30				



Prowadnica dolnego montażu ze spowalniaczem OSHX-18 3D
 Undermount drawer slide with soft closing OSHX-18 3D
 Направляющая нижнего монтажа с доводчиком OSHX-18 3D



NL krawędź szafki / cabinet edge / край шкафа

1. prowadnica lewa/prawa
drawer slide L/R
направляющая Л/П
2. sprzęgło lewe/prawe + wkręty
locking device L/R + screws
крепления фасада Л/П + саморезы

AV

NL = długość nominalna prowadnicy
nominal slide length
номинальная длина направляющей

AV = strata wysuwu
extension loss
потеря на выдвигании

Uwagi montażowe: dla prawidłowego działania szuflady jej szerokość nie może przekraczać długości nominalnej prowadnicy.
 Mounting information: for proper drawer operation, the width of the drawer can not exceed the nominal slide length.
 Техническое примечание: ширина ящика не должна превышать длину направляющей.

	 L mm	 AV mm		 kg		
PB-3DOSH18-300-H	300	16	pełny full полное	30	ocynk galvanized гальваника	stal steel сталь
PB-3DOSH18-350-H	350					
PB-3DOSH18-400-H	400					
PB-3DOSH18-450-H	450					
PB-3DOSH18-500-H	500					
PB-3DOSH18-550-H	550					



Prowadnica dolnego montażu ze spowalniczem 0SHX

Undermount drawer slide with soft closing 0SHX

Направляющая нижнего монтажа полного выдвижения с доводчиком 0SHX



Rozstaw otworów montażowych
Mounting dimensions
Монтажные отверстия

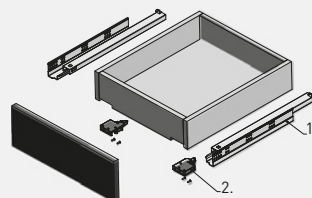
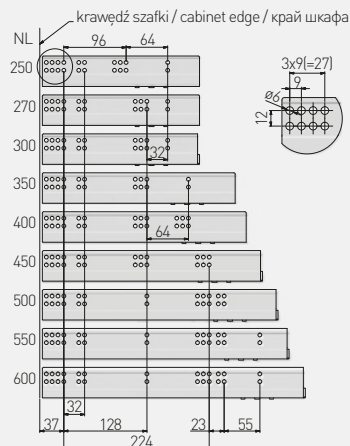

1. prowadnica lewa/prawa
drawer slide L/R
направляющая Л/П
2. sprzęgło lewe/prawe + wkręty
locking device L/R + screws
крепления фасада Л/П + саморезы

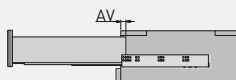

NL = długość nominalna prowadnicy
nominal slide length
номинальная длина направляющей
AV = strata wysuwu
extension loss
потеря на выдвижении

Uwagi montażowe: dla prawidłowego działania szuflady jej szerokość nie może przekraczać długości nominalnej prowadnicy.
Mounting information: for proper drawer operation, the width of the drawer can not exceed the nominal slide length.
Техническое примечание: ширина ящика не должна превышать длину направляющей.

	L mm	AV mm		kg		
PB-0SHX-250-A	250	16	pełny full полное	35		stal steel сталь
PB-0SHX-270-A	270					
PB-0SHX-300-A	300					
PB-0SHX-350-A	350					
PB-0SHX-400-A	400					
PB-0SHX-450-A	450					
PB-0SHX-500-A	500					
PB-0SHX-550-A	550					
PB-0SHX-600-A	600					







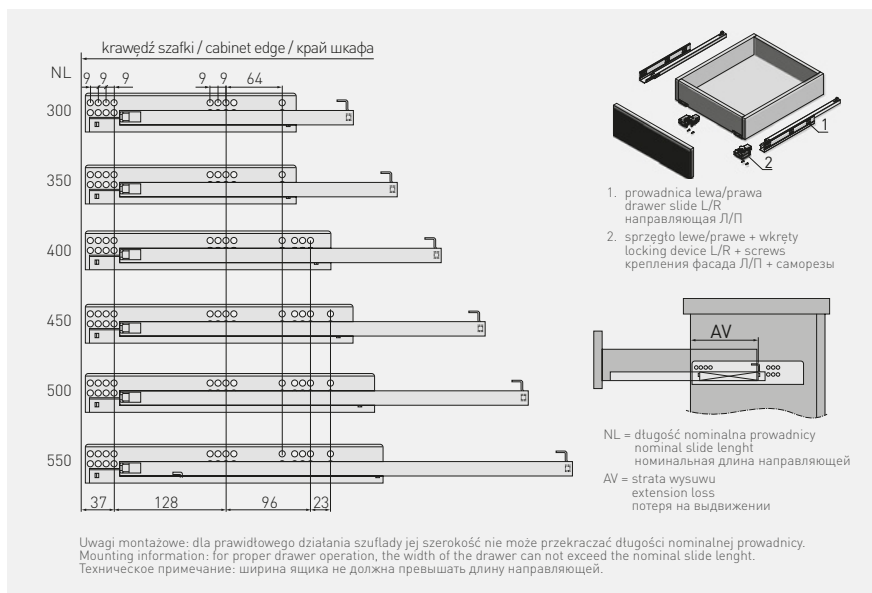

Prowadnica dolnego montażu ze spowalniaczem GCHX18-H

Undermount drawer slide with soft closing GCHX18-H

Направляющая нижнего монтажа неполное выдвигание с доводчиком GCHX18-H



		 L mm	 AV mm	 kg			
PB-GCHX18-300-H		300	88,5 mm	niepełny partial неполное	25 kg	ocynk galvanized гальваника	stal steel сталь
PB-GCHX18-350-H		350					
PB-GCHX18-400-H		400	118,5 mm				
PB-GCHX18-450-H		450					
PB-GCHX18-500-H		500					
PB-GCHX18-550-H		550					



Przewodnica dolnego montażu Modern Slide Pro push to open
 Undermount drawer slide Modern Slide Pro push to open
 Направляющая нижнего монтажа Modern Slide Pro push to open



krawędź szafki / cabinet edge / край шкафа

NL = długość nominalna prowadnicy
 nominal slide length
 номинальная длина направляющей

AV = strata wysuwu
 extension loss
 потеря на выдвигении

Uwagi montażowe: dla prawidłowego działania szuflady jej szerokość nie może przekraczać długości nominalnej prowadnicy.
 Mounting information: for proper drawer operation, the width of the drawer can not exceed the nominal slide length.
 Техническое примечание: ширина ящика не должна превышать длину направляющей.

	L mm	AV mm		kg		
PB-3D0FPO18-250-PRO	250	5	pełny full полное	35		stal steel
PB-3D0FPO18-300-PRO	300	-				
PB-3D0FPO18-350-PRO	350	-				
PB-3D0FPO18-400-PRO	400	-				
PB-3D0FPO18-450-PRO	450	-				
PB-3D0FPO18-500-PRO	500	-				
PB-3D0FPO18-550-PRO	550	-				
PB-3D0FPO18-600-PRO	600	-				
PB-SYNCHROP20-PRO	-	-				

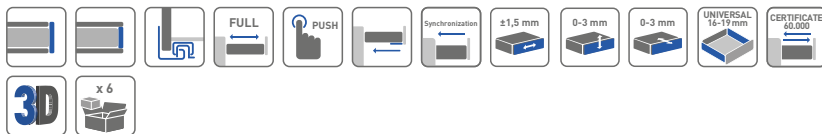

Wspornik szuflad cokołowych MORE SPACE
 Plinth drawer support MORE SPACE
 Опора плинтусного ящика MORE SPACE

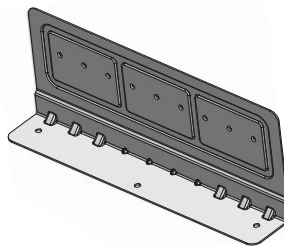

PB-WSPCOK

ocynk / galvanized / гальваника

stal / steel / сталь

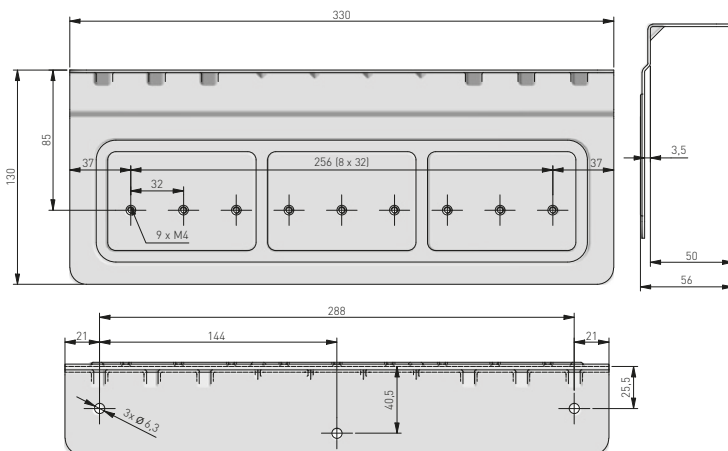

Prowadnica dolnego montażu push to open 0FPO18
 Undermount drawer slide push to open 0FPO18
 Направляющая нижнего монтажа push to open 0FPO18



Możliwość zastosowania stabilizatora PB-D-P20STAB
 Can be used with stabilizer PB-D-P20STAB
 Возможность использования стабилизатора стабилизатора PB-D-P20STAB

krawędź szafki / cabinet edge / край шкафа

NL = długość nominalna prowadnicy / nominal slide length / номинальная длина направляющей
 AV = strata wysunięciu / extension loss / потеря на выдвигении

Uwagi montażowe: dla prawidłowego działania szuflady jej szerokość nie może przekraczać długości nominalnej prowadnicy.
 Mounting information: for proper drawer operation, the width of the drawer can not exceed the nominal slide length.
 Техническое примечание: ширина ящика не должна превышать длину направляющей.

	L mm	AV mm		kg		
PB-0FPO18-250	250	26	pełny full полное	25	ocynk galvanized гальваника	stal steel сталь
PB-0FPO18-300	300					
PB-0FPO18-350	350					
PB-0FPO18-400	400					
PB-0FPO18-450	450					
PB-0FPO18-500	500					
PB-0FPO18-550	550					
PB-0FPO18-600	600					



Prowadnica kulkowa H53
Ball bearing slide H53
Шариковая направляющая H53

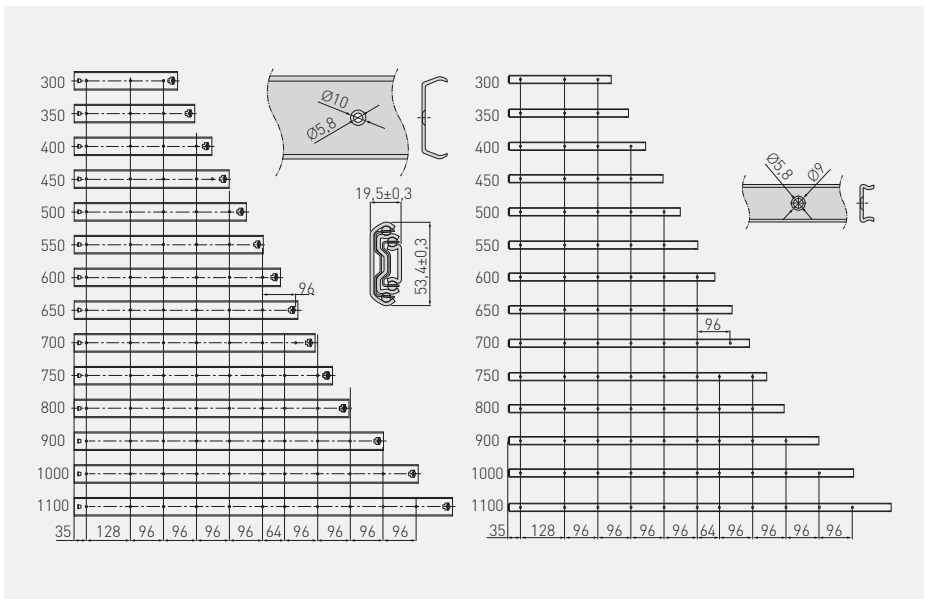

	L mm	AV mm	kg				L mm	AV mm	kg				
PK-0-H53-300	300	-					PK-0-H53-650	650	-				
PK-0-H53-350	350	-					PK-0-H53-700	700	-				
PK-0-H53-400	400	-	petny full полное	100	ocynk galvanized гальваника	stal steel сталь	PK-0-H53-750	750	-	petny full полное	100	ocynk galvanized гальваника	stal steel сталь
PK-0-H53-450	450	-					PK-0-H53-800	800	-				
PK-0-H53-500	500	-					PK-0-H53-900	900	-				
PK-0-H53-550	550	-					PK-0-H53-1000	1000	-				
PK-0-H53-600	600	-					PK-0-H53-1100	1100	-				





Prowadnica kulkowa VERSALITE PRO H45 push to open i soft close
 Ball bearing slide VERSALITE PRO H45 push to open & soft close
 Шариковая направляющая VERSALITE PRO H45 push to open с soft close

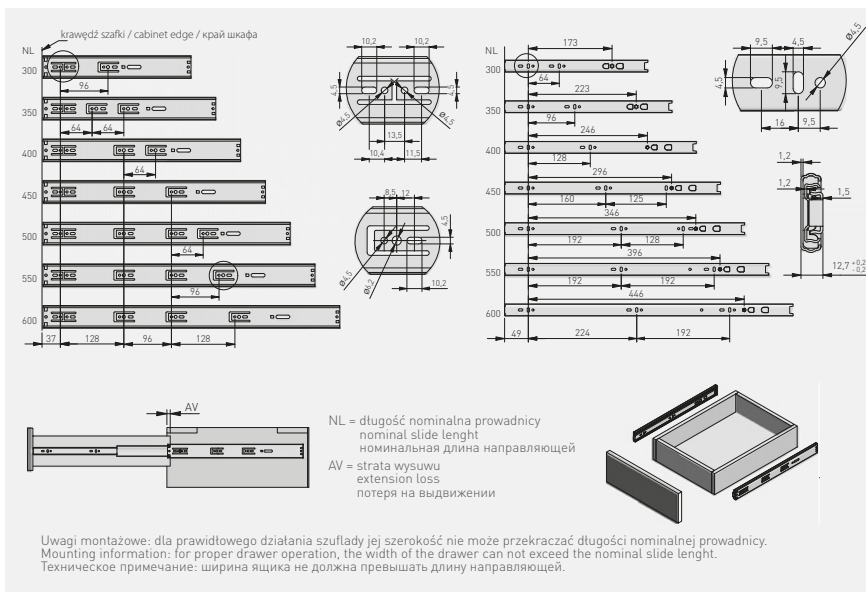







	L mm	AV mm		kg		
PK-L-P20-H45-300	300	52	pełny full полное	30		stal steel сталь
PK-L-P20-H45-350	350	35				
PK-L-P20-H45-400	400	20				
PK-L-P20-H45-450	450	4				
PK-L-P20-H45-500	500					
PK-L-P20-H45-550	550					
PK-L-P20-H45-600	600					

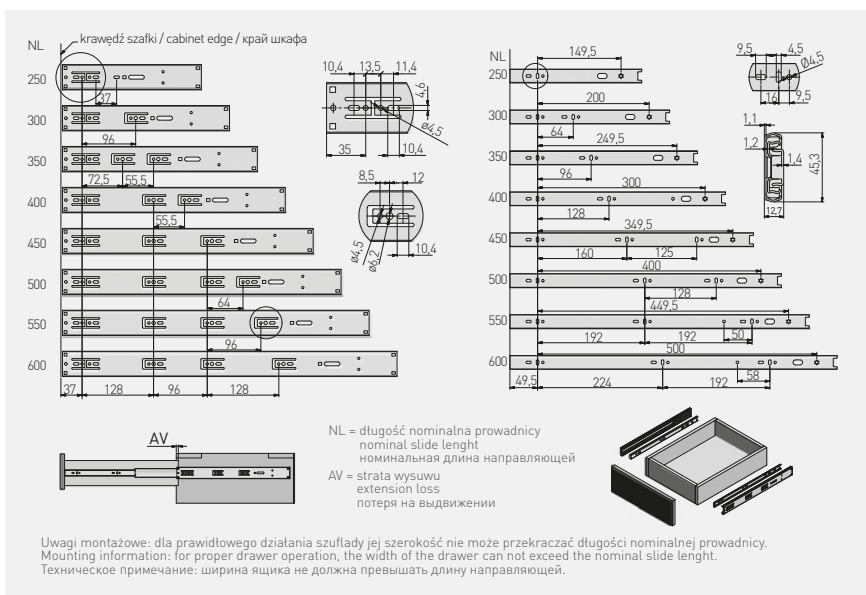



Prowadnica kulkowa VERSALITE PLUS ze spawalniczem H45
 Ball bearing slide VERSALITE PLUS with soft closing H45
 Шариковая направляющая VERSALITE PLUS с доводчиком H45



		 L mm	 AV mm				
	PK-L-H45-250	250*	102	petny full полное	30	ocynk galvanized гальваника	stal steel сталь
	PK-L-H45-300	300*	52				
	PK-L-H45-350	350*	35				
	PK-L-H45-400	400*	20				
	PK-L-H45-450	450	4				
	PK-L-H45-500	500					
	PK-L-H45-550	550					
	PK-L-H45-600	600					

* Brak pełnego wysuwu / Not full extension / Неполное выдвигение





Prowadnica kulkowa VERSALITE ze spowalniaczem H45*
 Ball bearing slide VERSALITE with soft closing H45*
 Шариковая направляющая VERSALITE с доводчиком H45*

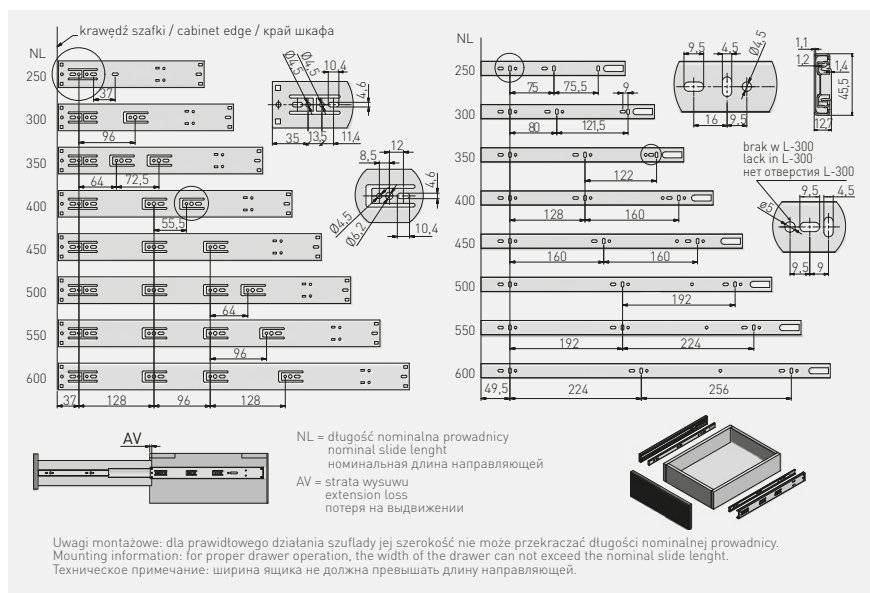

PK-L-H45-250-A		250**	55	pełny full полное	30	ocynk galvanized гальванка	stal steel сталь
PK-L-H45-300-A		300	15				
PK-L-H45-350-A		350	5				
PK-L-H45-400-A		400					
PK-L-H45-450-A		450	0				
PK-L-H45-500-A		500					
PK-L-H45-550-A		550					
PK-L-H45-600-A		600					





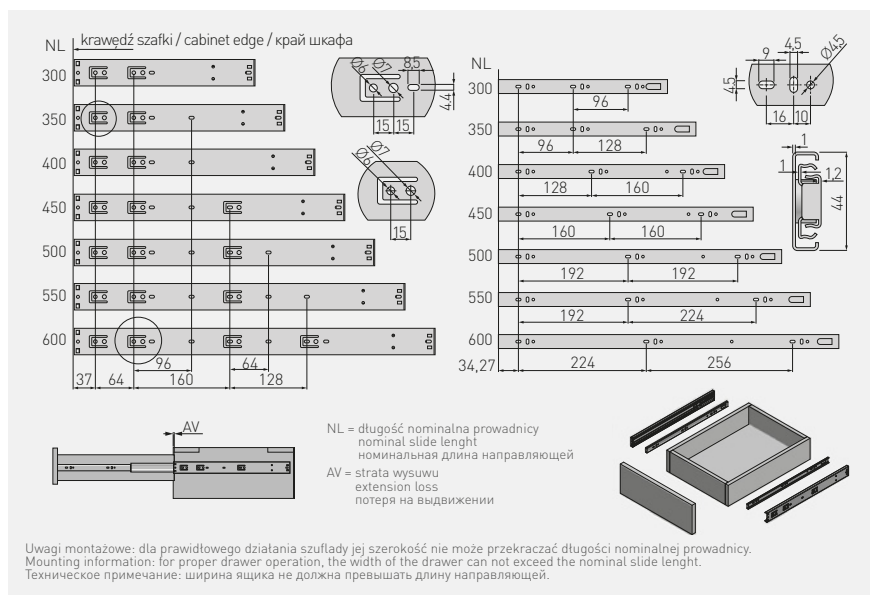

*Produkt dostępny na indywidualne zamówienie / Available for special orders / Товар доступен под заказ

** Brak pełnego wysuwu / Not full extension / Неполное выдвижение



Prowadnica kulkowa VERSALITE LIGHT ze spawalniczem H45
 Ball bearing slide VERSALITE LIGHT with soft closing H45
 Шариковая направляющая VERSALITE LIGHT с доводчиком H45









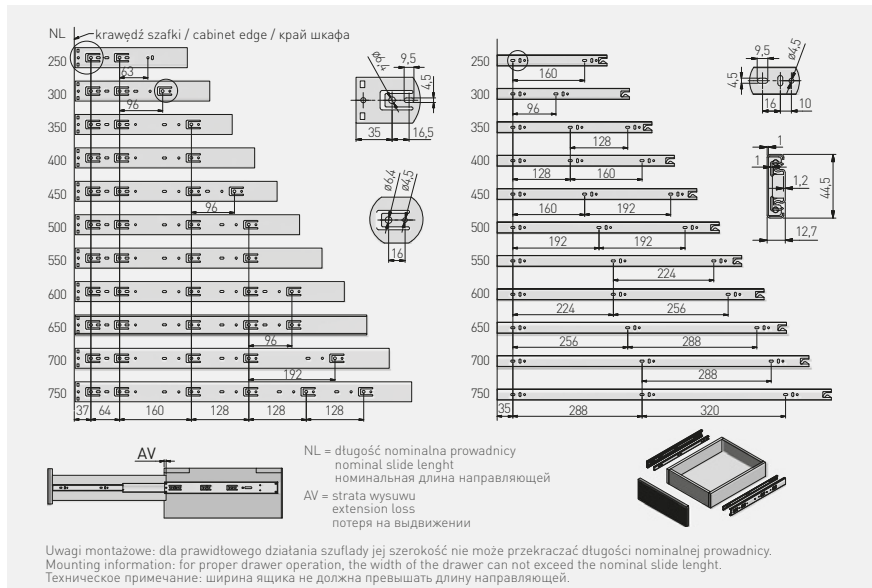

		 L mm	 AV mm		 kg		
PK-L-H45-300-GX		300*	50	pełny full полное	25	ocynk galvanized гальваника	stal steel сталь
PK-L-H45-350-GX		350	20				
PK-L-H45-400-GX		400	-				
PK-L-H45-450-GX		450	-				
PK-L-H45-500-GX		500	-				
PK-L-H45-550-GX		550	-				
PK-L-H45-600-GX		600	-				

* Brak pełnego wysuwu / Not full extension / Неполное выдвижение



Prowadnica kulkowa z samodociąganiem H45
 Ball bearing slide with self closing H45
 Шариковая направляющая с фиксатором H45







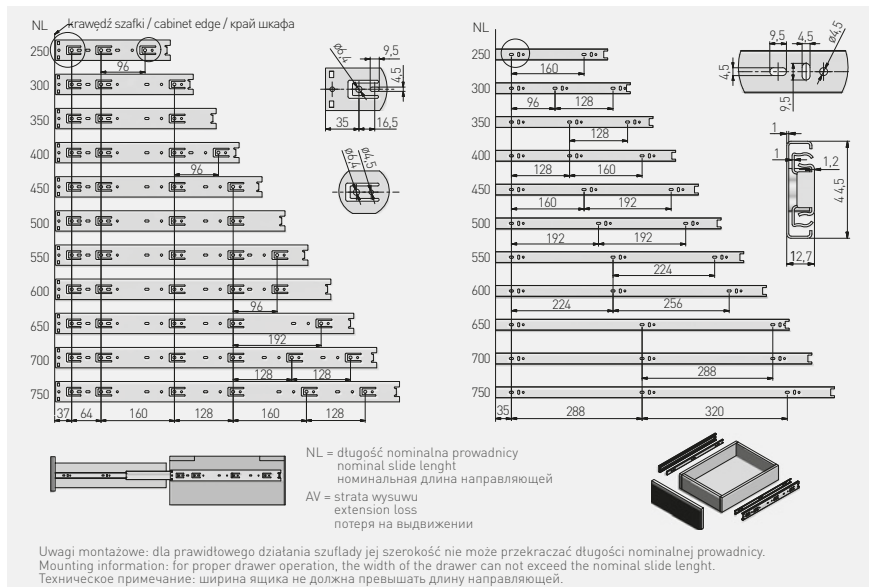

	 L mm	 AV mm		 kg			
PK-S-H45-250	250	22	pełny full полное	35	ocynk galvanized гальваника	stal steel сталь	15
PK-S-H45-300	300						
PK-S-H45-350	350						
PK-S-H45-400	400						
PK-S-H45-450	450						
PK-S-H45-500	500						
PK-S-H45-550	550						10
PK-S-H45-600	600						
PK-S-H45-650	650						
PK-S-H45-700	700						



Prowadnica kulkowa H45 PRESTIGE
 Ball bearing slide H45 PRESTIGE
 Шариковая направляющая H45 PRESTIGE



		 L mm	 AV mm				
PK-0-H45-250		250	-	35	ocynk galvanized гальваника	stal steel сталь	15
PK-0-H45-300		300					
PK-0-H45-350		350					
PK-0-H45-400		400					
PK-0-H45-450		450					
PK-0-H45-500		500					
PK-0-H45-550		550					
PK-0-H45-600		600	10				
PK-0-H45-700		700					





Prowadnica kulkowa push to open H45 GX
 Ball bearing slide push to open H45 GX
 Шариковая направляющая push to open H45 GX



Możliwość zastosowania stabilizatora PB-D-P20STAB
 Can be used with stabilizer PB-D-P20STAB
 Возможность использования стабилизатора PB-D-P20STAB

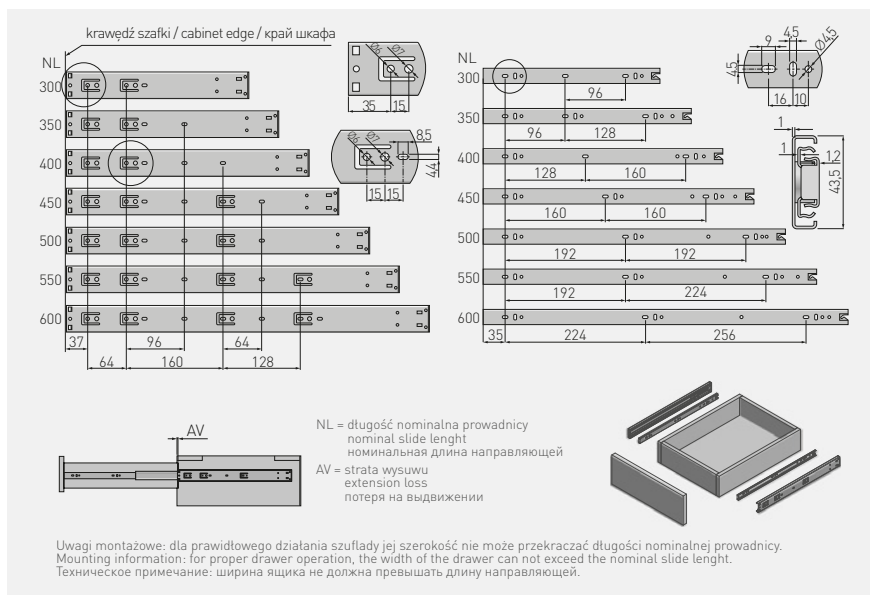







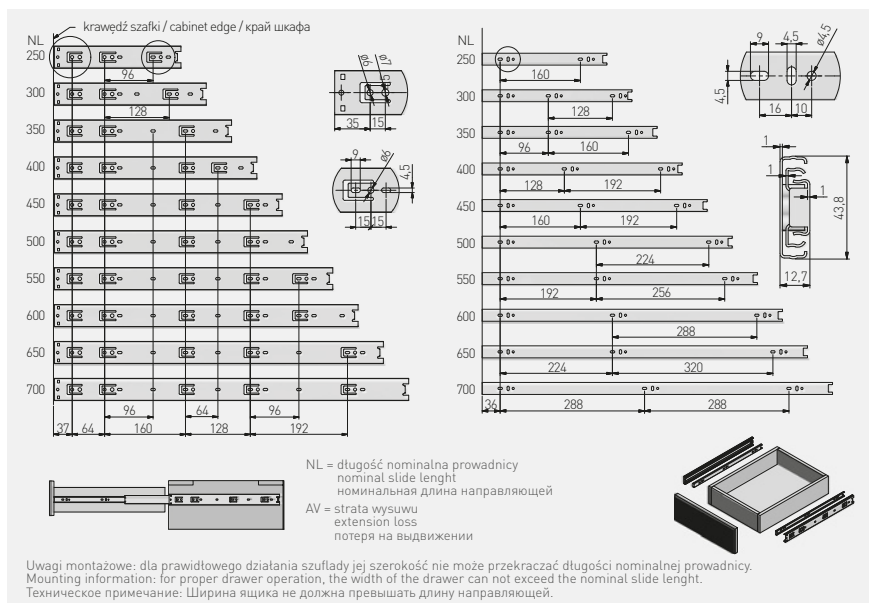

	L mm	AV mm		kg		
PK-P-H45-300-GX	300*	30	pełny full полное	25	ocynk galvanized гальванка	stal steel сталь
PK-P-H45-350-GX	350					
PK-P-H45-400-GX	400					
PK-P-H45-450-GX	450					
PK-P-H45-500-GX	500					
PK-P-H45-550-GX	550					
PK-P-H45-600-GX	600					

* Brak pełnego wysuwu / Not full extension / Неполное выдвигение



Prowadnica kulkowa H45 GX1
 Ball bearing slide H45 GX1
 Шариковая направляющая H45 GX1









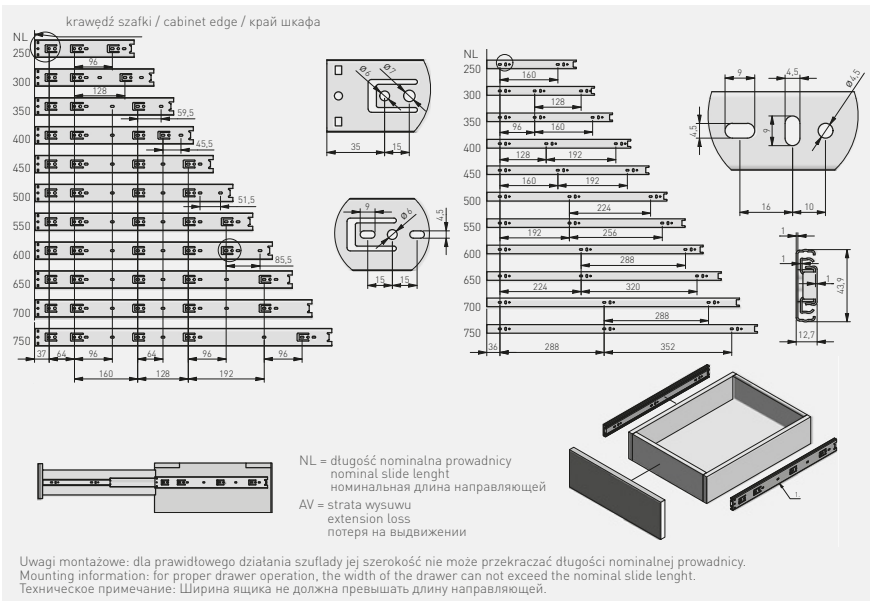

		 L mm	 AV mm		 kg 1		
PK-0H45250GX1		250	5	pełny full полное	30	ocynk galvanized гальваника	stal steel сталь
PK-0H45300GX1		300					
PK-0H45350GX1		350					
PK-0H45400GX1		400					
PK-0H45450GX1		450					
PK-0H45500GX1		500					
PK-0H45550GX1		550					
PK-0H45600GX1		600					
PK-0H45650GX1		650					
PK-0H45700GX1		700					



Prowadnica kulkowa H45 HK
 Ball bearing slide H45 HK
 Шариковая направляющая H45 HK

NEW







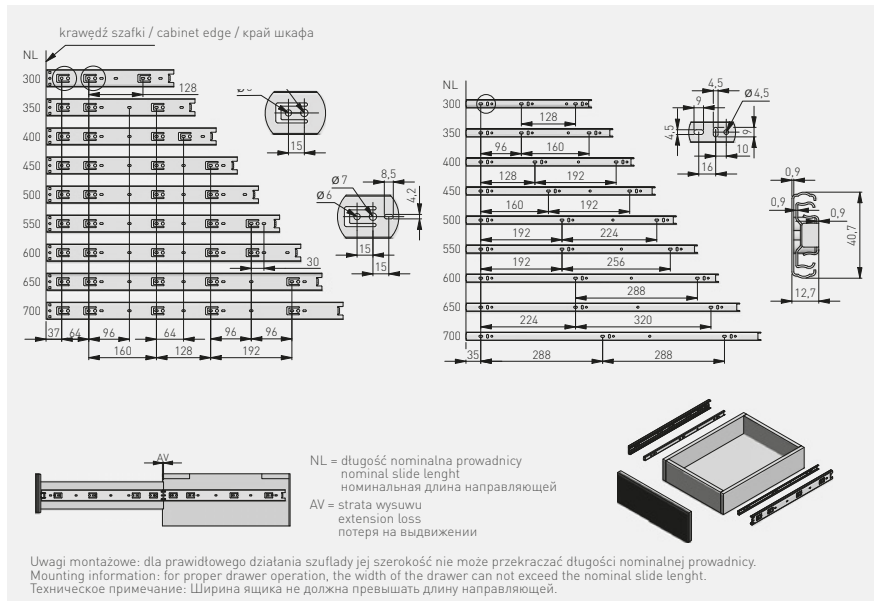

		 L mm	 AV mm		 kg		
PK-0H45250HK		250	5	pełny full полное	30	ocynk galvanized гальваника	stal steel сталь
PK-0H45300HK		300					
PK-0H45350HK		350					
PK-0H45400HK		400					
PK-0H45450HK		450					
PK-0H45500HK		500					
PK-0H45550HK		550					
PK-0H45600HK		600					
PK-0H45650HK		650					
PK-0H45700HK		700					
PK-0H45750HK		750					



Prowadnica kulkowa H45 GX2
 Ball bearing slide H45 GX2
 Шариковая направляющая H45 GX2







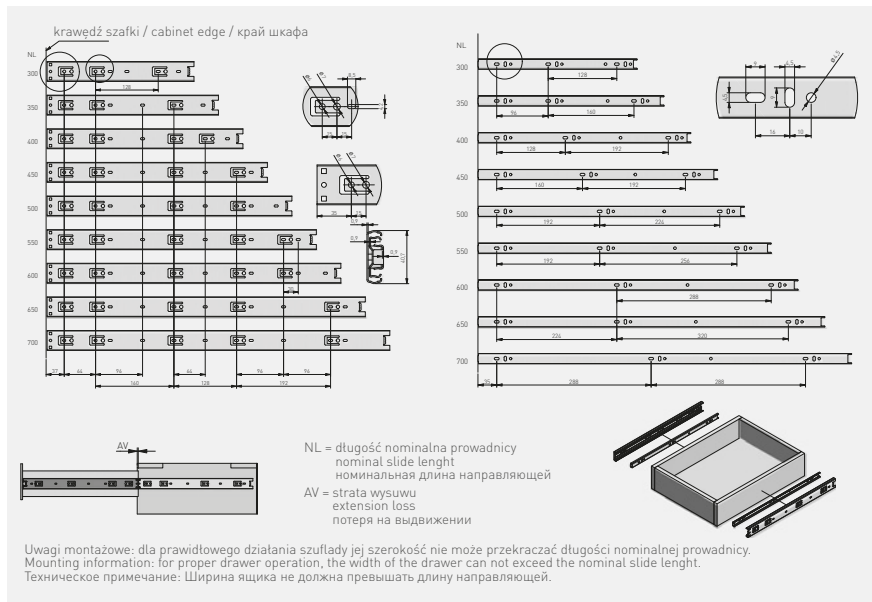

		 L mm	 AV mm		 kg		
PK-0H45300GX2		300		pełny full полное	25	ocynk galvanized гальваника	stal steel сталь
PK-0H45350GX2		350					
PK-0H45400GX2		400					
PK-0H45450GX2		450					
PK-0H45500GX2		500	-				
PK-0H45550GX2		550					
PK-0H45600GX2		600					
PK-0H45650GX2		650					
PK-0H45700GX2		700					



Prowadnica kulkowa H45 GX2-A
Ball bearing slide H45 GX2-A
Шариковая направляющая H45 GX2-A



		 L mm	 AV mm		 kg		
	PK-0H45300GX2-A	300	-	pełny full полное	25	ocynk galvanized гальваника	stal steel сталь
	PK-0H45350GX2-A	350					
	PK-0H45400GX2-A	400					
	PK-0H45450GX2-A	450					
	PK-0H45500GX2-A	500					
	PK-0H45550GX2-A	550					
	PK-0H45600GX2-A	600					
	PK-0H45650GX2-A	650					
	PK-0H45700GX2-A	700					



Prowadnica kulkowa H35
Ball bearing slide H35
Шариковая направляющая H35

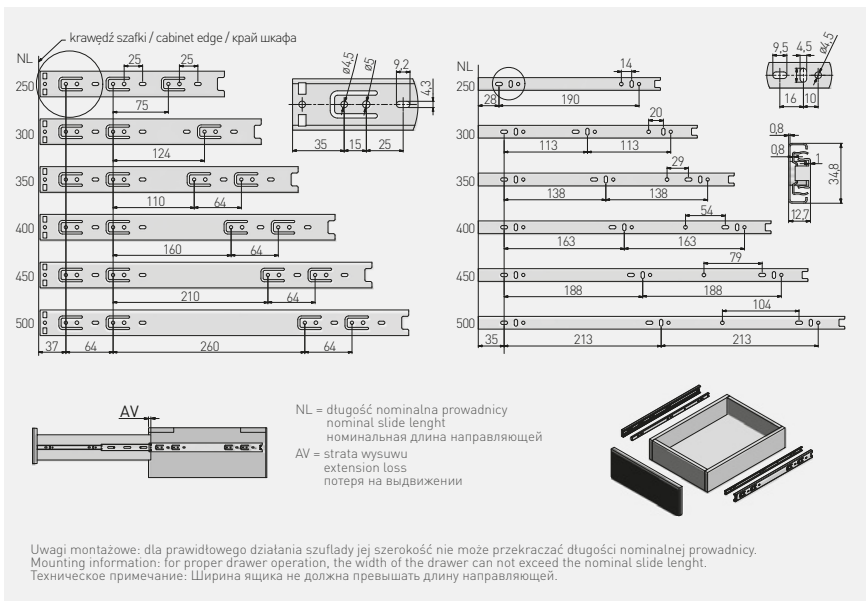





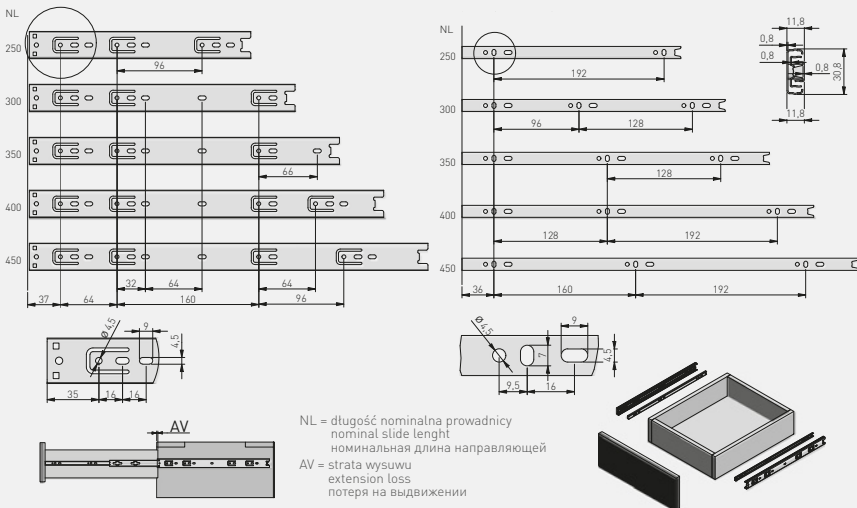

	L mm	AV mm		kg			
PK-0-H35-2500	250	4	pełny full полное	20	ocynk galvanized гальваника	stal steel сталь	20
PK-0-H35-3000	300						
PK-0-H35-3500	350						
PK-0-H35-4000	400						
PK-0-H35-4500	450						
PK-0-H35-5000	500						



Prowadnica kulkowa H30
Ball bearing slide H30
Шариковая направляющая H30



Uwagi montażowe: dla prawidłowego działania szuflady jej szerokość nie może przekraczać długości nominalnej prowadnicy.
Mounting information: for proper drawer operation, the width of the drawer can not exceed the nominal slide length.
Техническое примечание: Ширина ящика не должна превышать длину направляющей.

		 L mm	 AV mm		 kg		
PK-0H30-2500		250	-	petny full полное	15	osynek galvanized гальваника	stal steel сталь
PK-0H30-3000		300					
PK-0H30-3500		350					
PK-0H30-4000		400					
PK-0H30-4500		450					



Prowadnica kulkowa H30
Ball bearing slide H30
Шариковая направляющая H30





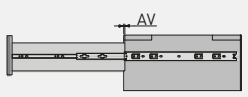
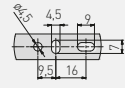
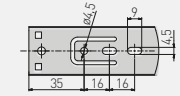
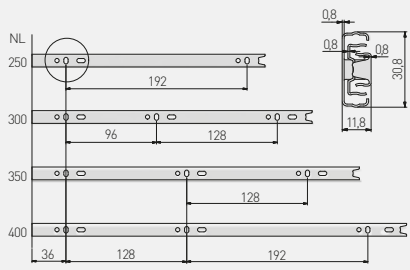
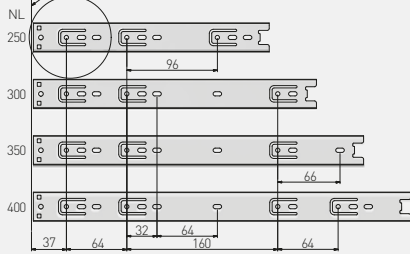

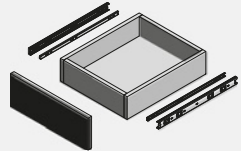

krawędź szafki / cabinet edge / край шкафа



NL = długość nominalna prowadnicy
nominal slide length
номинальная длина направляющей
AV = strata wysuwu
extension loss
потеря на выдвижении







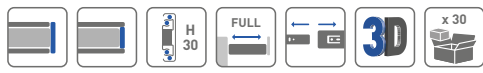

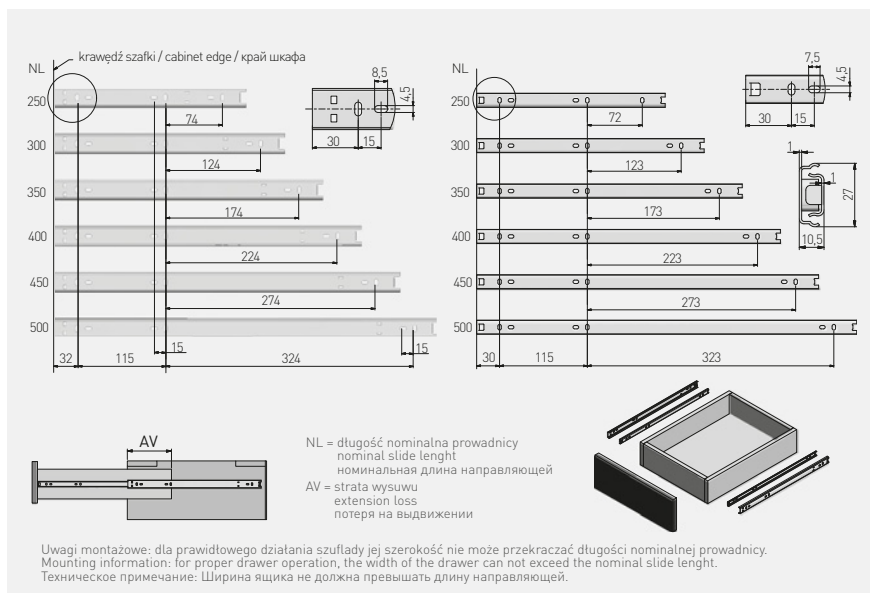

Uwagi montażowe: dla prawidłowego działania szuflady jej szerokość nie może przekraczać długości nominalnej prowadnicy.
Mounting information: for proper drawer operation, the width of the drawer can not exceed the nominal slide length.
Техническое примечание: Ширина ящика не должна превышать длину направляющей.

		 L mm	 AV mm			
PK-0H30-2500-A		250	-	petny full полное	15	stal galvanizowana galvanised steel оцинкованная сталь
PK-0H30-3000-A		300				
PK-0H30-3500-A		350				
PK-0H30-4000-A		400				



Prowadnica kulkowa H27
Ball bearing slide H27
Шариковая направляющая H27



		 L mm	 AV mm		 kg		
	PK-0H27-3000	300	109	niepełny partial неполное	15	ocynk galvanized гальваника	stal steel сталь
	PK-0H27-3500	350	124				
	PK-0H27-4000	400	134				
	PK-0H27-4500	450	149				
	PK-0H27-5000	500	184				



Prowadnica kulkowa do półki pod klawiaturę H27

Ball bearing slide for keyboard H27

Шариковая направляющая для полки под клавиатуру H27

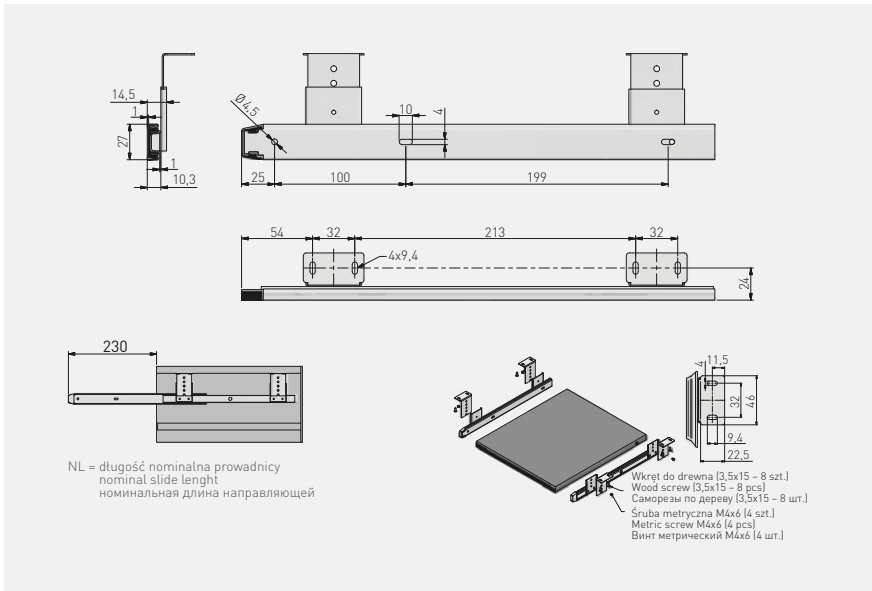







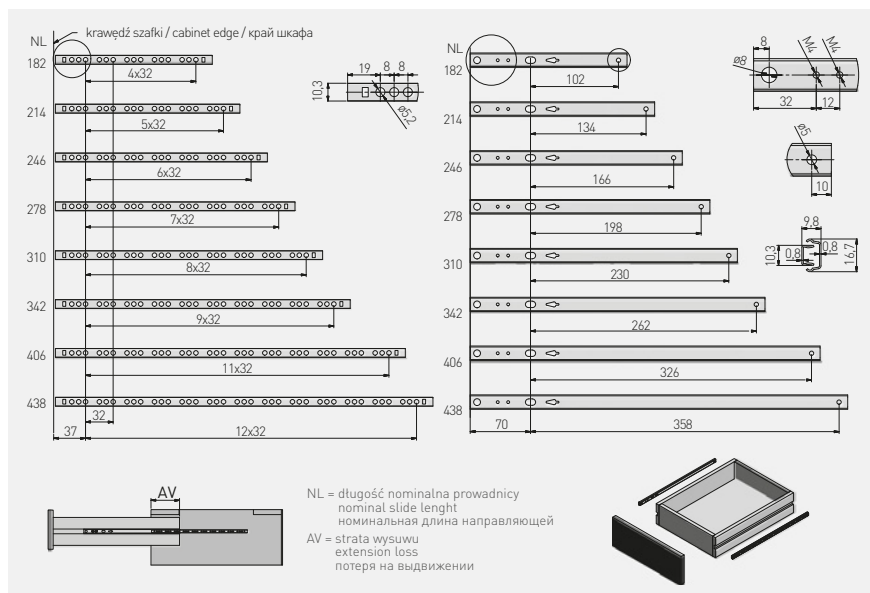

					
PK-0-000-027	360	niepełny partial неполное	5	ocynk galvanized гальваника	stal steel сталь



Prowadnica kulkowa H17
Ball bearing slide H17
Шариковая направляющая H17



		 L mm	 AV mm		 kg			
PK-0H17182XP		182	62	niepełny partial неполное	10	ocynk galvanized гальваника	stal steel сталь	100
PK-0H17214XP		214	77					
PK-0H17246XP		246						
PK-0H17278XP		278						
PK-0H17310XP		310						
PK-0H17342XP		342						
PK-0H17406XP		406	100					50
PK-0H17438XP		438						



Prowadnica rolkowa 0B
Euro roller slide 0B
Роликовая направляющая 0B

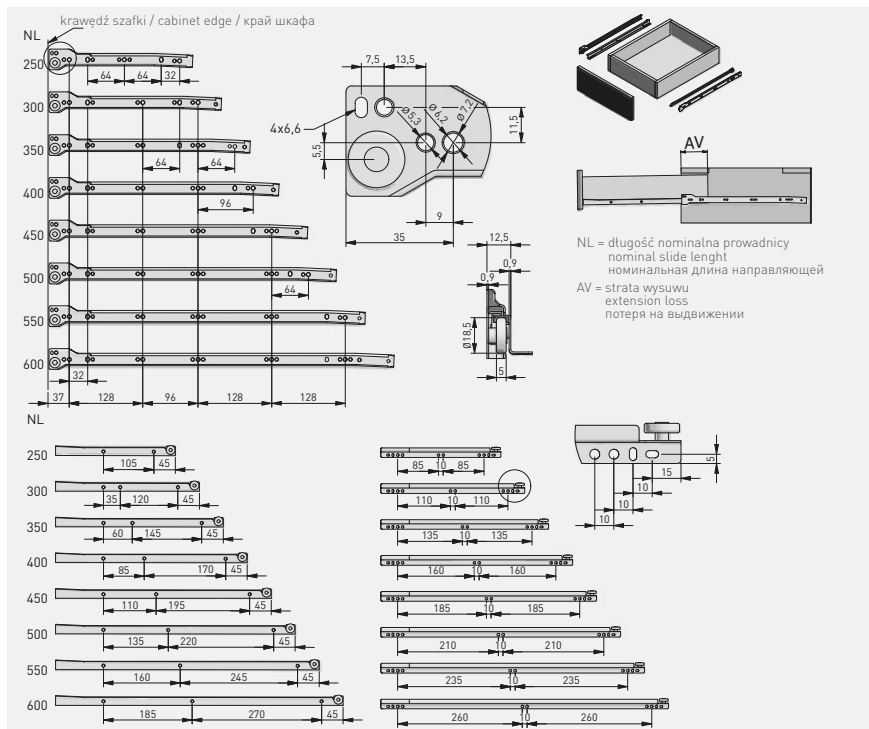

		L mm	AV mm	kg				L mm	AV mm	kg		
PR-0B-250-10		250					PR-0B-250-18*	250				
PR-0B-300-10		300					PR-0B-300-18*	300				
PR-0B-350-10		350	100				PR-0B-350-18*	350	100			
PR-0B-400-10		400					PR-0B-400-18*	400				
PR-0B-450-10		450					PR-0B-450-18*	450				
PR-0B-500-10		500	110				PR-0B-500-18*	500	110			
PR-0B-550-10		550	115				PR-0B-550-18*	550	115			
PR-0B-600-10		600	125				PR-0B-600-18*	600	125			



Prowadnica Metalbox MP
Slide Metalbox MP
Направляющая Metalbox MP





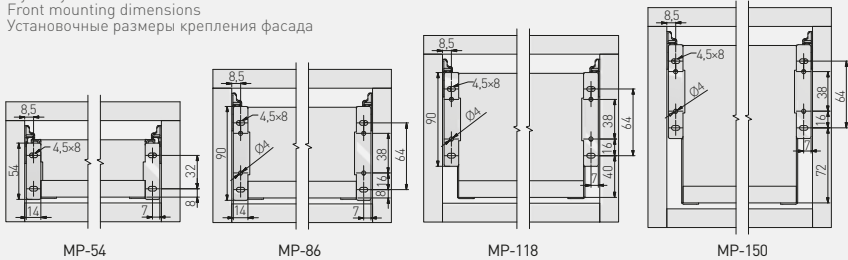



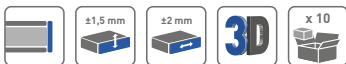
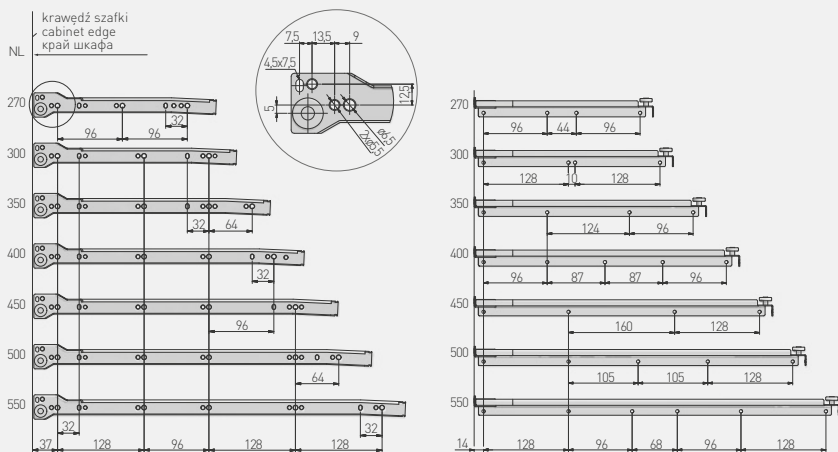









Wymiary montażowe mocowania frontu
Front mounting dimensions
Установочные размеры крепления фасада







Rozstaw otworów montażowych
Mounting dimensions
Монтажные отверстия

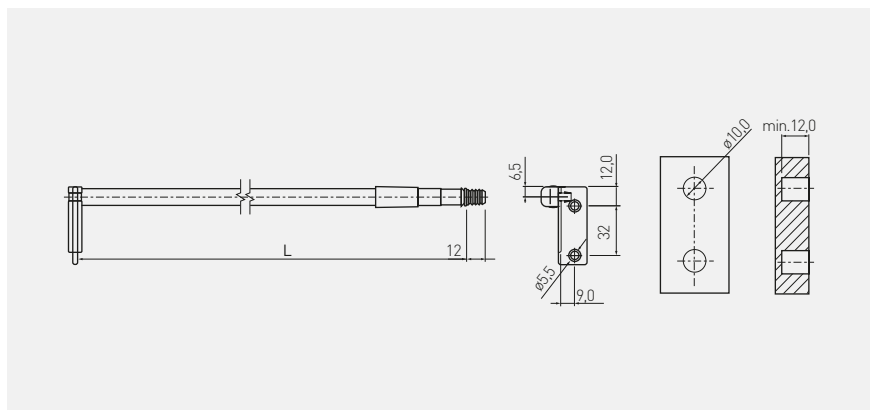

		 H mm	 L mm	 AV mm															
MP-054350-10	54	350	88	niepełny partial неполное	25	lakier lacquer лак													
MP-054400-10		400	98						biały white белый										
MP-054450-10		450																	
MP-054500-10		500																	
MP-054450-80		450							szary gray серый										
MP-054500-80		500																	
MP-086270-10	86	270	88						niepełny partial неполное	25	lakier lacquer лак								
MP-086300-10		300																	
MP-086350-10		350																	
MP-086400-10		400	98											biały white белый					
MP-086450-10		450																	
MP-086500-10		500																	
MP-086550-10		550												118					
MP-086350-80		350												88					
MP-086400-80		400	98											szary gray серый					
MP-086450-80		450																	
MP-086500-80		500																	
MP-118350-10		118	350											88	niepełny partial неполное	25	lakier lacquer лак		
MP-118400-10	400		98																
MP-118450-10	450																		
MP-118500-10	500																		
MP-150270-10	150	270	88						niepełny partial неполное	25	lakier lacquer лак								
MP-150300-10		300																	
MP-150350-10		350																	
MP-150400-10		400	98											biały white белый					
MP-150450-10		450																	
MP-150500-10		500																	
MP-150550-10		550												118					
MP-150350-80		350												88					
MP-150400-80		400	98											szary gray серый					
MP-150450-80		450																	
MP-150500-80		500																	

Reling z uchwytem ścianki tylnej lewy / prawy
 Rail with back panel connector left / right
 Релинг с ручкой задней стенки левый / правый



	 L mm	
RS-SZ-400-10	393 / 404	biały / white / белый
RS-SZ-450-10	443 / 454	
RS-SZ-500-10	493 / 504	

L – długość rzeczywista relingu mieszcząca się w przedziale [Lmin.; Lmax.] / actual length is within the range [Lmin.; Lmax.] / фактическая длина релинга в пределах [Lмин.; Lмакс]



Spowalniacz do prowadnic rolkowych oraz szuflad typu Metalbox 350-550 mm
 Soft closing device for euro roller slide and Metalbox 350-550 mm
 Доводчик для роликовых направляющих и Металбоксов 350-550 мм

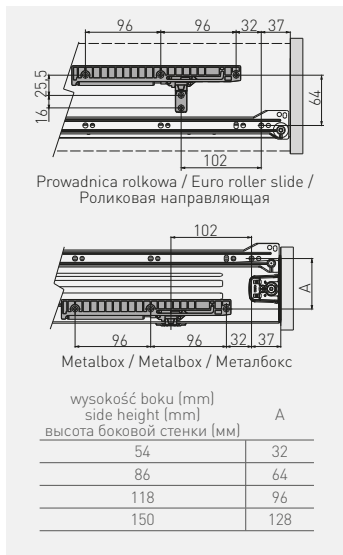

AM-MBSOFT-P2	25	szary gray серый	tworzywo plastic пластмасса



Rolka stabilizująca
 Drawer stabilizer
 Стабилизирующий механизм

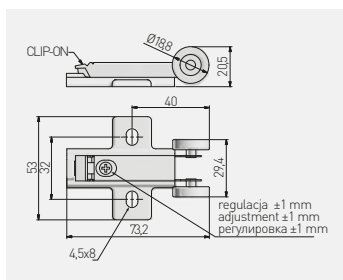

Do szuflad skrzyniowych wyposażonych w prowadnice push to open
 For drawers with push to open
 Для ящиков с направляющими push to open

PB-D-P20STAB	nikiel / nickel / никель	stal / steel / сталь



AXIS PRO

Skład zestawu

Set

Комплектация

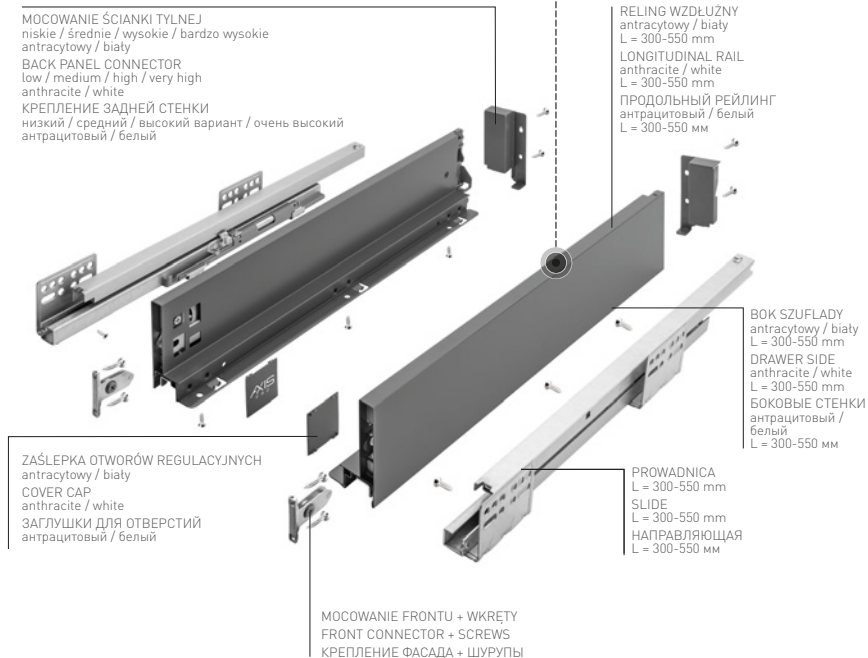

AXIS PRO

Komplet szuflady niskiej A
Low drawer set A
Низкий ящик A

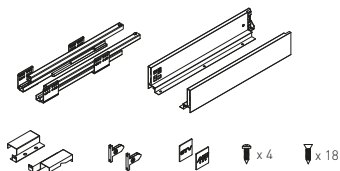

	L mm	kg						
PB-AXISPRO-KPL300A	300	40	antracyt anthracite антрацитовый	lakier lacquer лак	stal steel сталь			
PB-AXISPRO-KPL350A	350							
PB-AXISPRO-KPL400A	400							
PB-AXISPRO-KPL450A	450							
PB-AXISPRO-KPL500A	500							
PB-AXISPRO-KPL550A	550							
PB-AXISPRO-KPL300A1	300					biały white белый		
PB-AXISPRO-KPL350A1	350							
PB-AXISPRO-KPL400A1	400							
PB-AXISPRO-KPL450A1	450							
PB-AXISPRO-KPL500A1	500							
PB-AXISPRO-KPL550A1	550							

AXIS PRO

Komplet szuflady średniej B
Medium drawer set B
Средний ящик B

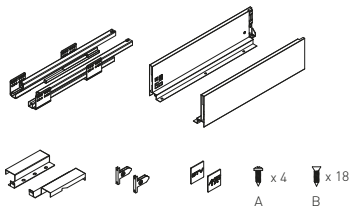

	L mm	kg						
PB-AXISPRO-KPL300B	300	40	antracyt anthracite антрацитовый	lakier lacquer лак	stal steel сталь			
PB-AXISPRO-KPL350B	350							
PB-AXISPRO-KPL400B	400							
PB-AXISPRO-KPL450B	450							
PB-AXISPRO-KPL500B	500							
PB-AXISPRO-KPL550B	550							
PB-AXISPRO-KPL300B1	300					biały white белый		
PB-AXISPRO-KPL350B1	350							
PB-AXISPRO-KPL400B1	400							
PB-AXISPRO-KPL450B1	450							
PB-AXISPRO-KPL500B1	500							
PB-AXISPRO-KPL550B1	550							

AXIS PRO

Komplet szuflady wysokiej C
High drawer set C
Высокий ящик C

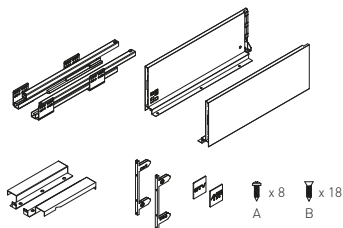

Model	Height (mm)	Color	Finish	Material
PB-AXISPRO-KPL300C	300	antracyt anthracite антрацитовый	lakier lacquer лак	stal steel сталь
PB-AXISPRO-KPL350C	350			
PB-AXISPRO-KPL400C	400			
PB-AXISPRO-KPL450C	450			
PB-AXISPRO-KPL500C	500			
PB-AXISPRO-KPL550C	550			
PB-AXISPRO-KPL300C1	300	biały white белый	lakier lacquer лак	stal steel сталь
PB-AXISPRO-KPL350C1	350			
PB-AXISPRO-KPL400C1	400			
PB-AXISPRO-KPL450C1	450			
PB-AXISPRO-KPL500C1	500			
PB-AXISPRO-KPL550C1	550			

AXIS PRO

Komplet szuflady bardzo wysokiej D
Very high drawer set D
Очень высокий ящик D

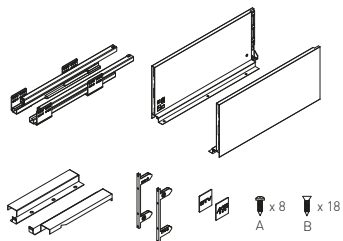

Model	Height (mm)	Color	Finish	Material
PB-AXISPRO-KPL300D	300	antracyt anthracite антрацитовый	lakier lacquer лак	stal steel сталь
PB-AXISPRO-KPL350D	350			
PB-AXISPRO-KPL400D	400			
PB-AXISPRO-KPL450D	450			
PB-AXISPRO-KPL500D	500			
PB-AXISPRO-KPL550D	550			
PB-AXISPRO-KPL300D1	300	biały white белый	lakier lacquer лак	stal steel сталь
PB-AXISPRO-KPL350D1	350			
PB-AXISPRO-KPL400D1	400			
PB-AXISPRO-KPL450D1	450			
PB-AXISPRO-KPL500D1	500			
PB-AXISPRO-KPL550D1	550			

AXIS PRO

Komplet szuflady ekstra niskiej

Very low drawer set

Набор ящиков очень низких

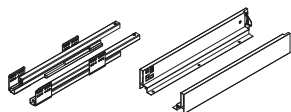





	 L mm	 kg			
PB-AXISPRO-KPL69-450-60	450	40	antracyt anthracite антрацитовый	lakier lacquer лак	stal steel сталь
PB-AXISPRO-KPL69-500-60	500				
PB-AXISPRO-KPL69-450-10	450		biały white белый		
PB-AXISPRO-KPL69-500-10	500				

Złączka frontu wewnętrzna niska

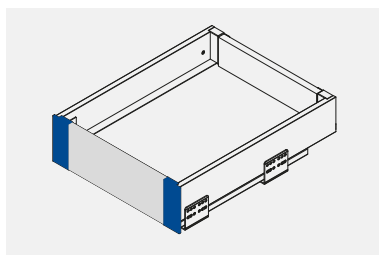
Inner front connector low

Соединитель передней панели, низкий



		
PB-AXISPRO-WEWMOCA	antracyt anthracite антрацитовый	stal steel сталь
PB-AXISPRO-WEWMOCA1	biały white белый	

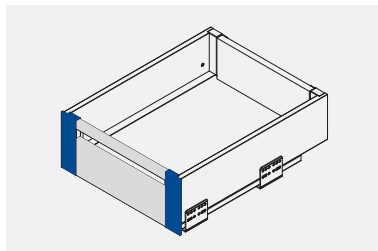

Złączka frontu wewnętrznego średnia
 Inner front connector medium
 Соединитель передней панели, передней



		
PB-AXISPRO-WEWM0CB	antracyt anthracite антрацитовый	stal steel сталь
PB-AXISPRO-WEWM0CB1	biały white белый	

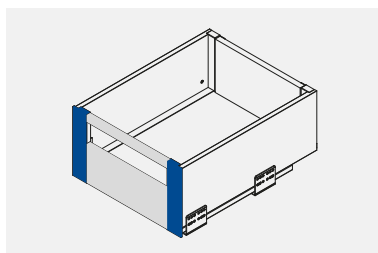

Złączka frontu wewnętrznego wysoka
 Inner front connector high
 Соединитель передней панели, высокий



		
PB-AXISPRO-WEWM0CC	antracyt anthracite антрацитовый	stal steel сталь
PB-AXISPRO-WEWM0CC1	biały white белый	

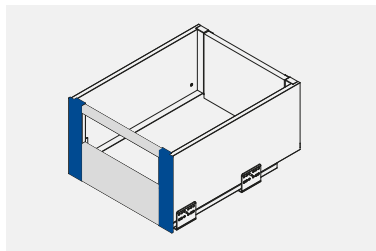



Złączka frontu wewnętrznego bardzo wysoka
 Inner front connector very high
 Соединитель передней панели, очень высокий

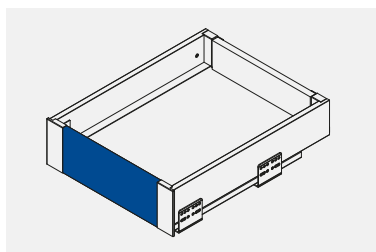
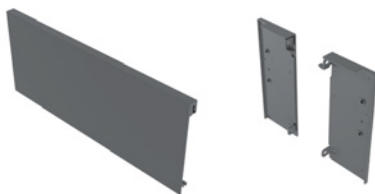

		
PB-AXISPRO-WEWMOCD	antracyt anthracite антрацитовый	stal steel сталь
PB-AXISPRO-WEWMOCD1	biały white белый	





Zestaw do szuflady wewnętrznej niskiej
 Set for low inside drawer
 Набор для внутреннего нижнего ящика

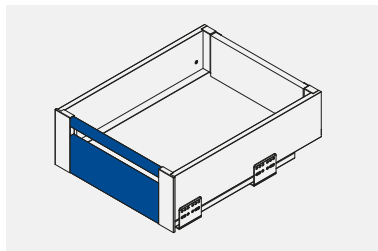

	 H mm	 L mm		
PB-AXISPRO-ZESWEW-A AXISPRO	110	1200	antracyt anthracite антрацитовый	stal steel сталь
PB-AXISPRO-ZESWEW-A1 AXISPRO			biały white белый	





Zestaw do szuflady wewnętrznej średniej
Set for medium inside drawer
Набор для среднего внутреннего ящика

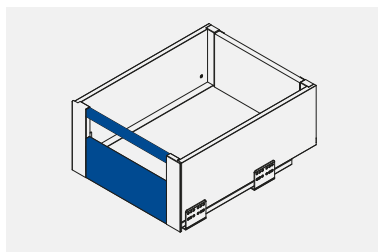
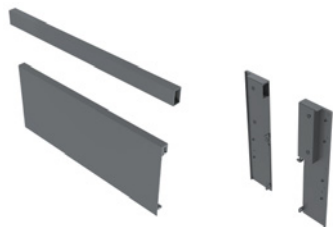

		 H mm	 L mm		
PB-AXISPRO-ZESWEW-B AXISPRO		95	1200	antracyt anthracite антрацитовый	stal steel сталь
PB-AXISPRO-ZESWEW-B1 AXISPRO				biały white белый	

Zestaw do szuflady wewnętrznej wysokiej
Set for high inside drawer
Набор для внутреннего высокого ящика



		 H mm	 L mm		
PB-AXISPRO-ZESWEW-C AXISPRO		110	1200	antracyt anthracite антрацитовый	stal steel сталь
PB-AXISPRO-ZESWEW-C1 AXISPRO				biały white белый	

Zestaw do szuflady wewnętrznej bardzo wysokiej
 Set for very high inside drawer
 Набор для очень высокого внутреннего ящика

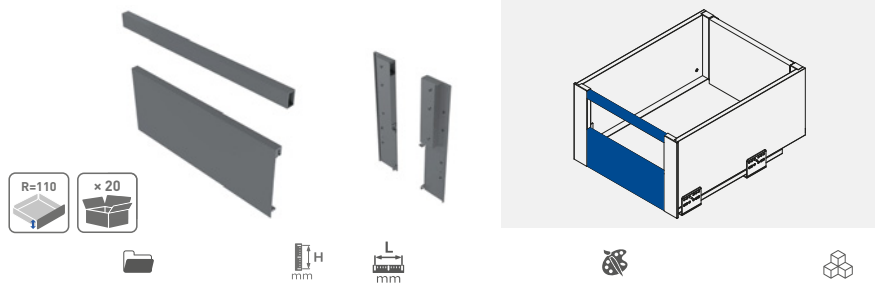

PB-AXISPRO-ZESWEW-D AXISPRO	110	1200	antracyt / anthracite / антрацитовый	stal steel
PB-AXISPRO-ZESWEW-D1 AXISPRO			biały / white / белый	

Reling wzdluzny kwadratowy
 Square longitudinal railing
 Квадратные продольные перила



PB-AXISPRO-RELKW300	300	antracyt anthracite антрацитовый	stal steel
PB-AXISPRO-RELKW350	350		
PB-AXISPRO-RELKW400	400		
PB-AXISPRO-RELKW450	450		
PB-AXISPRO-RELKW500	500		
PB-AXISPRO-RELKW550	550		
PB-AXISPRO-RELKW300-10	300		
PB-AXISPRO-RELKW350-10	350		
PB-AXISPRO-RELKW400-10	400		
PB-AXISPRO-RELKW450-10	450		
PB-AXISPRO-RELKW500-10	500		
PB-AXISPRO-RELKW550-10	550		

Znacznik do mocowania frontów AxisPro
 Marker for fixing AxisPro front panels
 Маркер для монтажа фасадов AxisPro

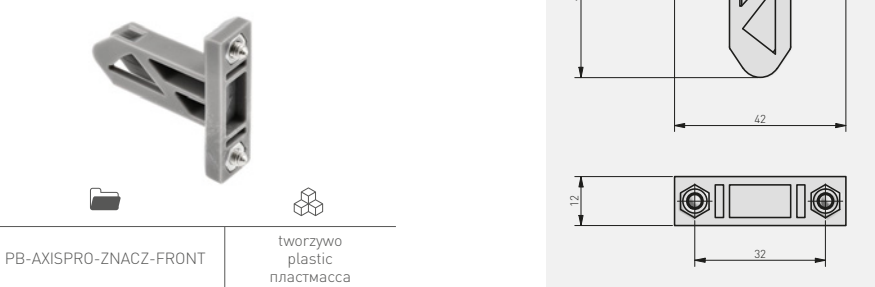

PB-AXISPRO-ZNACZ-FRONT	tworzywo plastic пластмасса
------------------------	-----------------------------------

Modern Box Square

Skład zestawu

Set

Комплектация

MOCOWANIE ŚCIANKI TYLNEJ

niskie / średnie / wysokie
szare / białe

BACK PANEL CONNECTOR

low / medium / high
gray / white

КРЕПЛЕНИЕ ЗАДНЕЙ СТЕНКИ

низкий / средний / высокий вариант
серый / белый

RELING WZDŁUŻNY

szary / biały
L = 250-550 mm

LONGITUDINAL RAIL

gray / white
L = 250-550 mm

ПРОДОЛЬНЫЙ РЕЙЛИНГ

серый / белый
L = 250-550 мм

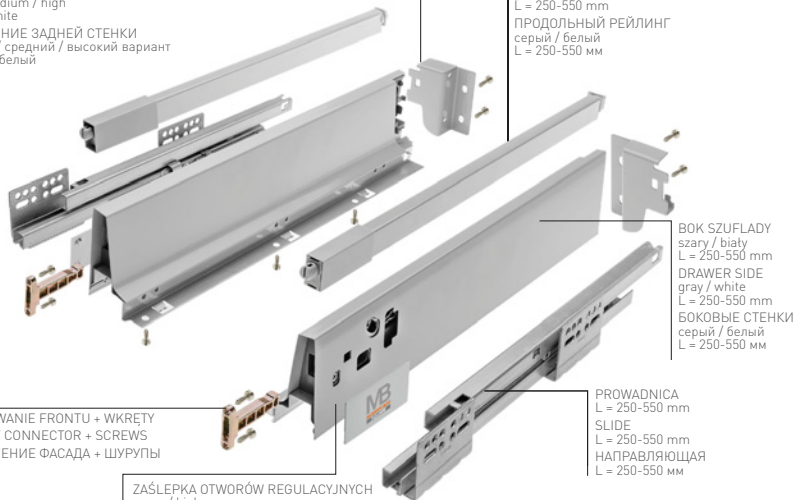

MOCOWANIE FRONTU + WKRETY

FRONT CONNECTOR + SCREWS

КРЕПЛЕНИЕ ФАСАДА + ШУРУПЫ

ZASŁEPKA OTWORÓW REGULACYJNYCH

szara / biała

COVER CAP

gray / white

ЗАГЛУШКИ ДЛЯ ОТВЕРСТИЙ

серый / белый

PROWADNICA

L = 250-550 mm

SLIDE

L = 250-550 mm

НАПРАВЛЯЮЩАЯ

L = 250-550 mm

БОК SZUFLADY

szary / biały

L = 250-550 mm

DRAWER SIDE

gray / white

L = 250-550 mm

БОКОВЫЕ СТЕНКИ

серый / белый







L = 250-550 мм

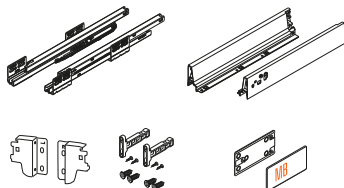

Modern Box Square

Komplet szuflady niskiej A
Low drawer set A
Низкий ящик A







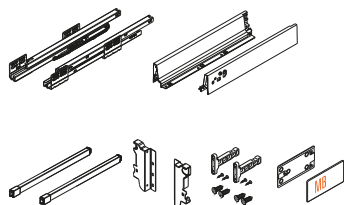

		 L mm	 kg			
PB-KW-KPL250A	250	40				
PB-KW-KPL300A	300					
PB-KW-KPL350A	350					
PB-KW-KPL400A	400					
PB-KW-KPL450A	450					
PB-KW-KPL500A	500					
PB-KW-KPL550A	550					
PB-KW-KPL600A	600					
PB-KW-KPL250A1	250					
PB-KW-KPL300A1	300					
PB-KW-KPL350A1	350					
PB-KW-KPL400A1	400					
PB-KW-KPL450A1	450					
PB-KW-KPL500A1	500					
PB-KW-KPL550A1	550					
PB-KW-KPL600A1	600					

Modern Box Square

Komplet szuflady średniej B
Medium drawer set B
Средний ящик B



		 L mm	 kg			
PB-KW-KPL250B	250	40				
PB-KW-KPL300B	300					
PB-KW-KPL350B	350					
PB-KW-KPL400B	400					
PB-KW-KPL450B	450					
PB-KW-KPL500B	500					
PB-KW-KPL550B	550					
PB-KW-KPL600B	600					
PB-KW-KPL250B1	250					
PB-KW-KPL300B1	300					
PB-KW-KPL350B1	350					
PB-KW-KPL400B1	400					
PB-KW-KPL450B1	450					
PB-KW-KPL500B1	500					
PB-KW-KPL550B1	550					
PB-KW-KPL600B1	600					

Modern Box Square

Komplet szuflady wysokiej C
High drawer set C
Высокий ящик C

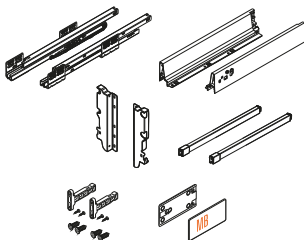

PB-KW-KPL250C	250	40	szary gray серый	lakier lacquer лак	stal steel сталь
PB-KW-KPL300C	300				
PB-KW-KPL350C	350				
PB-KW-KPL400C	400				
PB-KW-KPL450C	450				
PB-KW-KPL500C	500				
PB-KW-KPL550C	550		biały white белый		
PB-KW-KPL600C	600				
PB-KW-KPL250C1	250				
PB-KW-KPL300C1	300				
PB-KW-KPL350C1	350				
PB-KW-KPL400C1	400				
PB-KW-KPL450C1	450				
PB-KW-KPL500C1	500				
PB-KW-KPL550C1	550				
PB-KW-KPL600C1	600				



Reling wzdużny Longitudinal drawer rail Продольный рейлинг

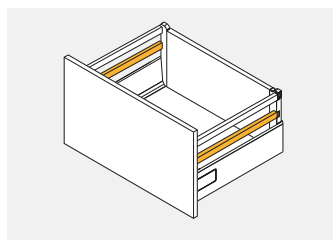

PB-D-RELKW350	350	szary gray серый	lakier lacquer лак	stal steel сталь
PB-D-RELKW400	400			
PB-D-RELKW450	450			
PB-D-RELKW500	500			
PB-D-RELKW550	550			



PB-D-RELKW350-10	350	biały white белый	lakier lacquer лак	stal steel сталь
PB-D-RELKW400-10	400			
PB-D-RELKW450-10	450			
PB-D-RELKW500-10	500			
PB-D-RELKW550-10	550			



Złączka frontu wewnętrznego, niska
 Inner front connector, low
 Соединитель передней панели, низкий

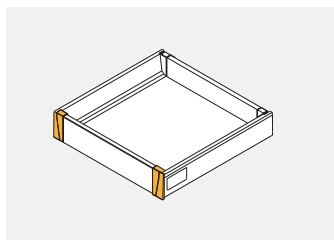

PB-D-WEWMOCA-KW	szuflada niska A low drawer A низкий ящик A	szary / gray / серый	tworzywo plastic пластмасса
PB-D-WEWMOCA-KW-10		biały / white / белый	



Złączka frontu wewnętrznego, średnia
 Inner front connector, medium
 Соединитель передней панели, средний

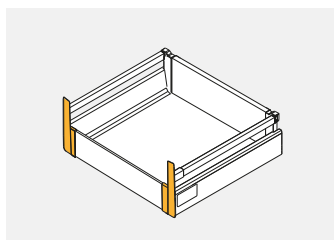

PB-D-WEWMOCB-KW	szuflada średnia B medium drawer B средний ящик B	szary / gray / серый	tworzywo plastic пластмасса
PB-D-WEWMOCB-KW-10		biały / white / белый	



Złączka frontu wewnętrznego, wysoka
 Inner front connector, high
 Соединитель передней панели, высокий

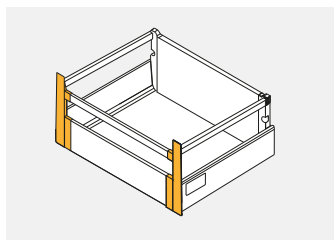

PB-D-WEWMOCC-KW	szuflada wysoka C high drawer C высокий ящик C	szary / gray / серый	tworzywo plastic пластмасса
PB-D-WEWMOCC-KW-10		biały / white / белый	



Zestaw do szuflady wewnętrznej wysokiej Modern Box Square
 Set for high inside drawer Modern Box Square
 Набор для внутреннего высокого ящика Modern Box Square

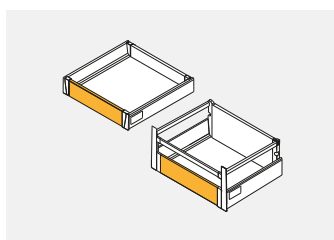

PB-D-ZESWEWKW-C	1100	szary / gray / серый	aluminium aluminium алюминий
PB-D-ZESWEWKW-C-10		biały / white / белый	



Zestaw do organizacji szuflady wewnętrznej Modern Box Square

Set for inside drawer organization Modern Box Square

Комплект для внутренней организации ящиков Modern Box Square

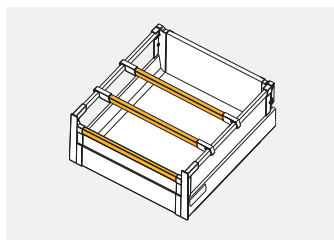

	 L mm		
PB-D-WEWORGKW-A	1100	szary / gray / серый	stal steel сталь
PB-D-WEWORGKW-A-10		biały / white / белый	





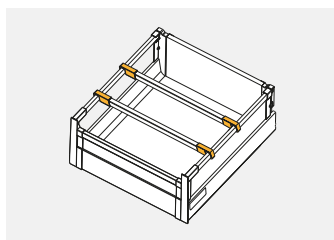

Łącznik relingu poprzecznego

Transverse rail connector

Соединитель поперечного рейлинга



			
PB-D-ZR-KW-00	1 kpl. = 2 szt. 1 set = 2 pcs 1 комп. = 2 шт.	szary / gray / серый	tworzywo plastic пластмасса
PB-D-ZR-KW-10		biały / white / белый	



Zestaw do organizacji szuflady wewnętrznej
 Set for inside drawer organization
 Комплект для внутренней организации ящиков

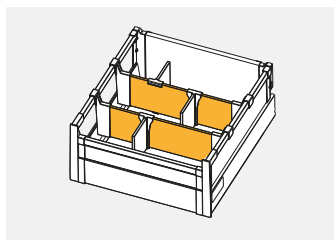

			
PB-D-WEWORGKW-B	1100	szary / gray / серый	aluminium aluminium алюминий
PB-D-WEWORGKW-B-10		biały / white / белый	



Złączka do listwy poprzecznej
 Transverse bar connector
 Соединитель поперечной планки

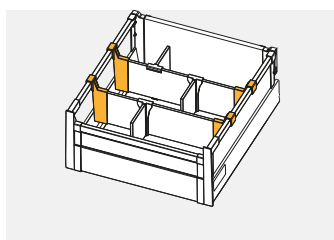

			
PB-D-CONREL-KW	1 kpl. = 2 szt. 1 set = 2 pcs 1 комп. = 2 шт.	szary / gray / серый	tworzywo plastic пластмасса
PB-D-CONREL-KW-10		biały / white / белый	



Przegroda do listwy poprzecznej
 Transverse bar divider
 Перегородка для поперечной планки

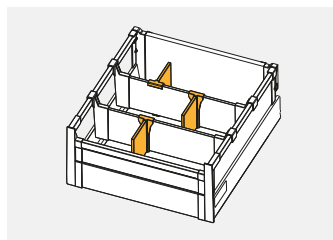

PB-D-PRZEGLP-KW	1 szt. 1 pc	szary / gray / серый	tworzywo plastic пластмасса
PB-D-PRZEGLP-KW-10	1 шт.	biały / white / белый	



Mocowanie relingu do podwyższonej ścianki tylnej
 Back panel connector for rails, additional
 Соединитель задней стенки для рейлингов, дополнительная

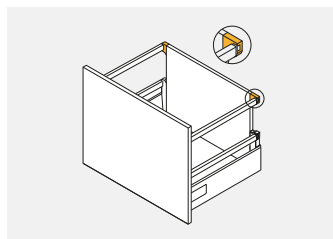





PB-D-D2R0-00	1 kpl. = 2 szt. 1 set = 2 pcs	szary / gray / серый	tworzywo plastic пластмасса
PB-D-D2R0-01	1 комп. = 2 шт.	biały / white / белый	

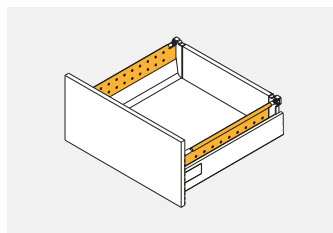
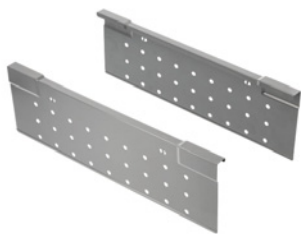

Bok perforowany
Perforated side
Перфорированная сторона



	 L mm		
PB-D-BXSIDEKW25C	250	szary gray серый	stal steel сталь
PB-D-BXSIDEKW30C	300		
PB-D-BXSIDEKW35C	350		
PB-D-BXSIDEKW40C	400		
PB-D-BXSIDEKW45C	450		
PB-D-BXSIDEKW50C	500		
PB-D-BXSIDEKW55C	550		
PB-D-BXSIDEKW25C-10	250	biały white белый	
PB-D-BXSIDEKW30C-10	300		
PB-D-BXSIDEKW35C-10	350		
PB-D-BXSIDEKW40C-10	400		
PB-D-BXSIDEKW45C-10	450		
PB-D-BXSIDEKW50C-10	500		
PB-D-BXSIDEKW55C-10	550		



Złączka ścianki tylnej, niska
 Back panel connector, low
 Держатель задней стенки, низкий

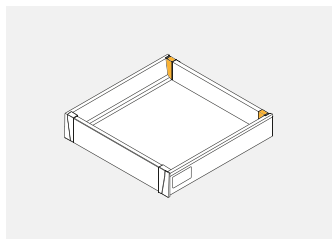

PB-D-N2R0-00	1 kpl. = L+P 1 set = L+R	szary / gray / серый	stal steel
PB-D-N2R0-01	1 комп. = Л+П	biały / white / белый	сталь



Złączka ścianki tylnej, średnia
 Back panel connector, medium
 Держатель задней стенки, средний

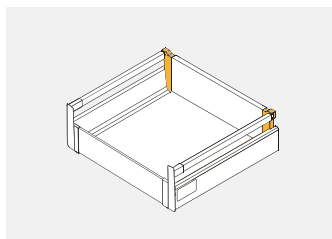

PB-D-S2R0-00	1 kpl. = L+P 1 set = L+R	szary / gray / серый	stal steel
PB-D-S2R0-01	1 комп. = Л+П	biały / white / белый	сталь



Złączka ścianki tylnej, wysoka
 Back panel connector, high
 Держатель задней стенки, высокий

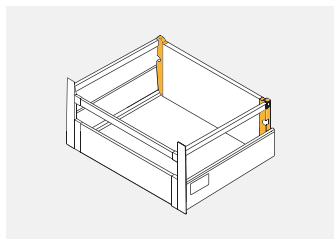

PB-D-W2R0-00	1 kpl. = L+P 1 set = L+R	szary / gray / серый	stal steel
PB-D-W2R0-01	1 комп. = Л+П	biały / white / белый	stal steel



Mocowanie do relingów
 Rails mounting
 Держатель рейлинга



PB-D-MHG04-KW	1 szt. 1 pc 1 шт.	szary gray серый	tworzywo plastic пластмасса
---------------	-------------------------	------------------------	-----------------------------------



Matryca do relingów
 Marking gauge for rails
 Матрица для рейлингов



PB-D-MATRYCA	1 kpl. = 1 szt. 1 set = 1 pc 1 комп. = 1 шт.	szary gray серый	tworzywo plastic пластмасса
--------------	--	------------------------	-----------------------------------



Znacznik do frontów
 Marking gauge for drawer front
 Маркер фасада



PB-D-ZNACZ-0	1 kpl. = 2 szt. 1 set = 2 pcs 1 комп. = 2 шт.	szary gray серый	ZnAl
--------------	---	------------------------	------



Modern Box

Skład zestawu

Set



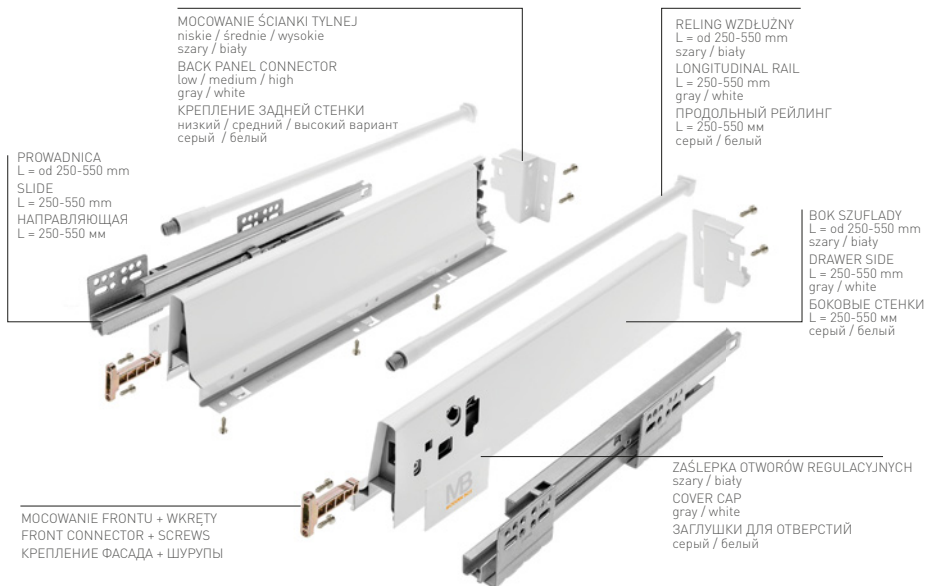



Комплектация

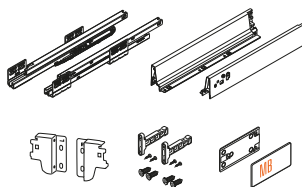

Modern Box

Komplet szuflady niskiej A
Low drawer set A
Низкий ящик А



							
PB-D-KPL250A		250	soft close	szary gray серый	40	lakier lacquer лак	stal steel сталь
PB-D-KPL300A		300					
PB-D-KPL350A		350					
PB-D-KPL400A		400					
PB-D-KPL450A		450					
PB-D-KPL500A		500					
PB-D-KPL550A		550					
PB-D-KPL250A1		250		push to open		szary gray серый	
PB-D-KPL300A1		300					
PB-D-KPL350A1		350					
PB-D-KPL400A1		400					
PB-D-KPL450A1		450					
PB-D-KPL500A1		500					
PB-D-KPL550A1		550					
PB-D-P20250A		250	push to open	szary gray серый			
PB-D-P20300A		300					
PB-D-P20350A		350					
PB-D-P20400A		400					
PB-D-P20450A		450					
PB-D-P20500A		500					



Modern Box

Komplet szuflady średniej B
Medium drawer set B
Средний ящик B

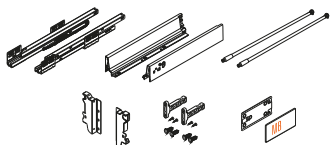

PB-D-KPL250B	250	soft close	40	szary gray серый	lakier lacquer лак	stal steel сталь
PB-D-KPL300B	300					
PB-D-KPL350B	350					
PB-D-KPL400B	400					
PB-D-KPL450B	450					
PB-D-KPL500B	500					
PB-D-KPL550B	550					
PB-D-KPL250B1	250					
PB-D-KPL300B1	300					
PB-D-KPL350B1	350					
PB-D-KPL400B1	400					
PB-D-KPL450B1	450					
PB-D-KPL500B1	500					
PB-D-KPL550B1	550					

Modern Box



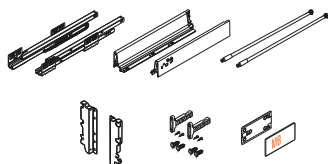



Komplet szuflady wysokiej C
High drawer set C
Высокий ящик C

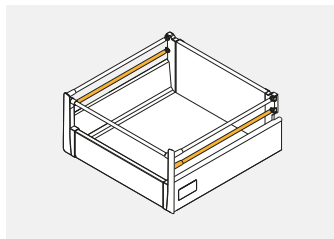







PB-D-KPL250C	250	soft close	40	szary gray серый	lakier lacquer лак	stal steel сталь		
PB-D-KPL300C	300							
PB-D-KPL350C	350							
PB-D-KPL400C	400							
PB-D-KPL450C	450							
PB-D-KPL500C	500							
PB-D-KPL550C	550							
PB-D-KPL250C1	250							
PB-D-KPL300C1	300							
PB-D-KPL350C1	350							
PB-D-KPL400C1	400							
PB-D-KPL450C1	450							
PB-D-KPL500C1	500							
PB-D-KPL550C1	550							
PB-D-P20300C	300			push to open		szary gray серый		
PB-D-P20350C	350							
PB-D-P20400C	400							
PB-D-P20450C	450							
PB-D-P20500C	500							
PB-D-P20550C	550							

Reлинг wzdużny
Longitudinal rail
Продольный рейлинг







	 L mm		
PB-D-REL2500	250		
PB-D-REL3000	300		
PB-D-REL3500	350		
PB-D-REL4000	400		
PB-D-REL4500	450		
PB-D-REL5000	500		
PB-D-REL5500	550		
		szary gray серый	stal steel сталь

	 L mm		
PB-D-REL300-10	300		
PB-D-REL350-10	350		
PB-D-REL400-10	400		
PB-D-REL450-10	450		
PB-D-REL500-10	500		
PB-D-REL550-10	550		

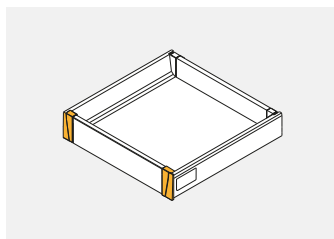

Złączka frontu wewnętrznego, niska
Inner front connector, low
Соединитель передней панели, низкий



			
PB-D-WEWMOCA	szuflada niska A low drawer A низкий ящик A	szary / gray / серый	tworzywo plastic пластмасса
PB-D-WEWMOCA1		biały / white / белый	



Złączka frontu wewnętrzного, średnia
 Inner drawer connector, medium
 Соединитель передней панели, средний

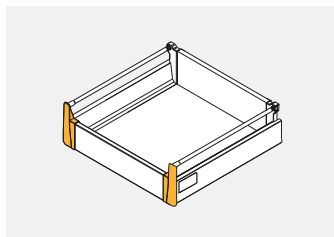

PB-D-WEWMOCB	szuflada średnia B medium drawer B средний ящик B	szary / gray / серый biały / white / белый	tworzywo plastic пластмасса
PB-D-WEWMOCB1			



Złączka frontu wewnętrzного, wysoka, do 1 kompletu relingów
 Inner drawer connector high, for 1 set of rails
 Соединитель передней панели, высокий, для 1 комплекта рейлингов

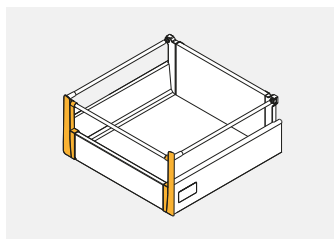



PB-D-WEWSZKLC	szuflada wysoka C, 1 reling high drawer C, 1 rail высокий ящик C, рейлинг - 1 шт.	szary / gray / серый biały / white / белый	tworzywo plastic пластмасса
PB-D-WEWSZKLC-10			

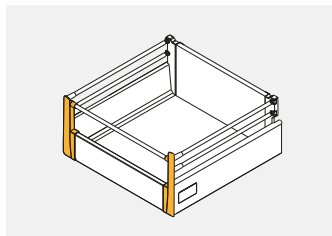
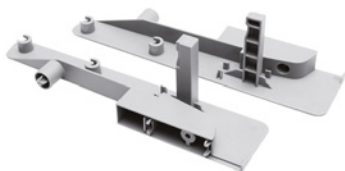

Złączka frontu wewnętrznej, wysoka, do 2 kompletów relingów
 Inner drawer front connector, high, for 2 sets of rails
 Соединитель передней панели, высокий, для 2 комплектов рельгов







			
PB-D-WEWMOCC	szuflada wysoka C, 2 relingi high drawer C, 2 rails	szary / gray / серый	tworzywo plastic
PB-D-WEWMOCC1	wysoki jasek C, reling -2 szt.	biały / white / белый	пластмасса

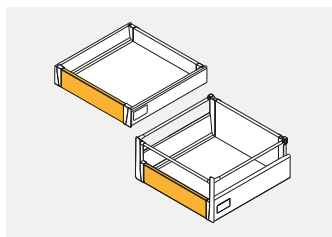

Zestaw do szuflady wewnętrznej wysokiej
 Set for high inside drawer
 Набор для внутреннего высокого ящика







			
PB-D-ZESWEW-C	1100	szary / gray / серый	aluminium
PB-D-ZESWEW-C-10		biały / white / белый	aluminium алюминий

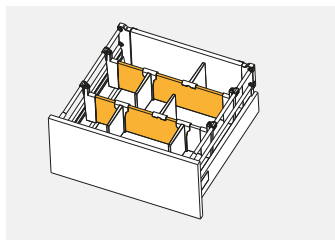

Zestaw do organizacji szuflady wewnętrznej
Set for inside drawer organization
Комплект для внутренней организации ящиков







	 L mm		
PB-D-WEWORG-A	1100	szary / gray / серый	aluminium aluminium алюминий
PB-D-WEWORG-A-10		biały / white / белый	
PB-D-WEWORG-B		szary / gray / серый	
PB-D-WEWORG-B-10		biały / white / белый	

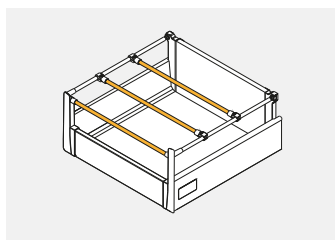

Reлинг poprzeczny
Transverse rail
Поперечный рейлинг



	 L mm		
PB-D-RP-1100	1100	szary / gray / серый	stal steel сталь
PB-D-RP-1100-10		biały / white / белый	



Łącznik relingu poprzecznego
 Transverse rail connector
 Соединитель поперечного рейлинга

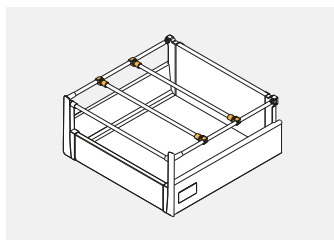

			
PB-D-ZR-00-0	1 kpl. = 2 szt. 1 set = 2 pcs	szary / gray / серый	tworzywo plastic пластмасса
PB-D-ZR-00-10	1 комп. = 2 шт.	biały / white / белый	



Uchwyt do szuflady wewnętrznej
 Inner drawer handle
 Ручка для внутреннего ящика

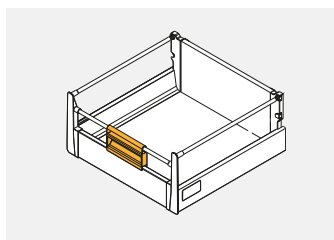

		
PB-D-UCHWEW	szary / gray / серый	tworzywo plastic пластмасса
PB-D-UCHWEW-10	biały / white / белый	



Łącznik krzyżowy do relingu
 Cross rail connector
 Крестообразный соединитель рейлингов

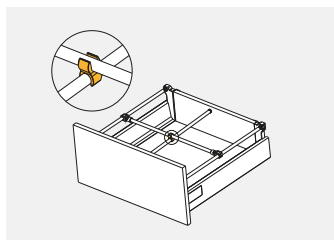

PB-D-LR-00-0	szary / gray / серый	tworzywo plastic пластмасса
PB-D-LR-00-10	biały / white / белый	



Zaślepka do relingu poprzecznego
 End cap for transverse rail
 Заглушка для поперечного рейлинга

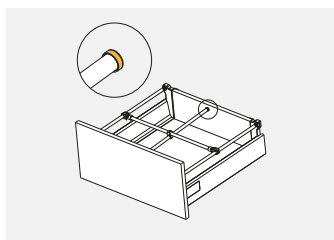

PB-D-RELCOV	szary / gray / серый	tworzywo plastic пластмасса
PB-D-RELCOV-10	biały / white / белый	



Złączka listwy poprzecznej do relingu
 Connector for transverse rail and bar
 Соединитель поперечных планок и рейлингов

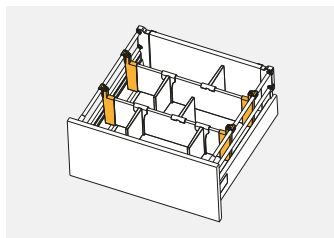

PB-D-CONREL	1 kpl. = 2 szt. 1 set = 2 pcs 1 комп. = 2 шт.	szary / gray / серый	tworzywo plastic пластмасса
PB-D-CONREL-10		biały / white / белый	



Złączka listwy poprzecznej do boku perforowanego
 Transverse bar connector for perforated sides
 Соединитель поперечных планок и перфорированных боковин

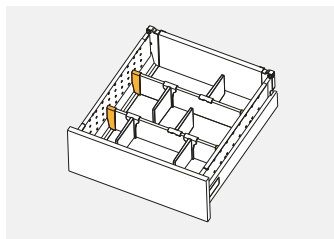

PB-D-CONBXSID	1 kpl. = 2 szt. 1 set = 2 pcs 1 комп. = 2 шт.	szary / gray / серый	tworzywo plastic пластмасса
PB-D-CONBXSIDE-10		biały / white / белый	



Przegroda listwy poprzecznej
 Transverse bar divider
 Перегородка для поперечной планки

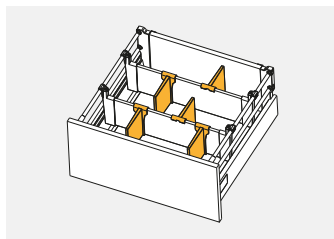

PB-D-PRZEGLP	szary / gray / серый	tworzywo plastic пластмасса
PB-D-PRZEGLP-10	biały / white / белый	



Bok perforowany do szuflady średniej
 Perforated side for medium drawer
 Перфорированная боковина, низкая

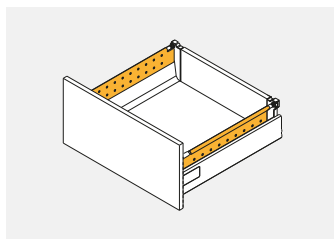





PB-D-BXSIDE45B	450	szary / gray / серый	stal steel сталь
PB-D-BXSIDE45B-10		biały / white / белый	
PB-D-BXSIDE50B	500	szary / gray / серый	
PB-D-BXSIDE50B-10		biały / white / белый	

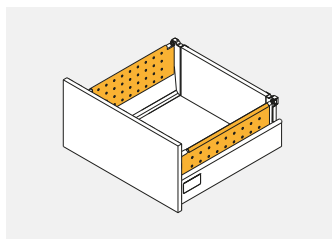
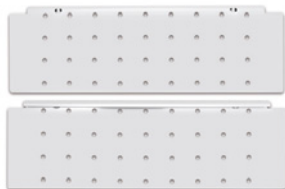

Bok perforowany do szuflady wysokiej
 Perforated side for high drawer
 Перфорированная боковина, высокая







	 L mm		
PB-D-BXSIDE45C	450	szary / gray / серый	stal steel сталь
PB-D-BXSIDE45C-10		biały / white / белый	
PB-D-BXSIDE50C	500	szary / gray / серый	
PB-D-BXSIDE50C-10		biały / white / белый	

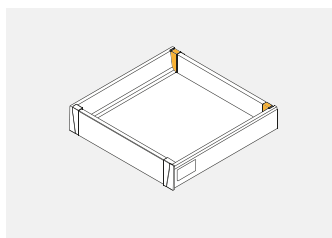

Złączka ścianki tylnej, niska
 Back panel connector, low
 Соединитель задней стенки, низкий







			
PB-D-N2R0-00	1 kpl. = L+P 1 set = L+R 1 комп. = Л+П	szary / gray / серый	stal steel сталь
PB-D-N2R0-01		biały / white / белый	

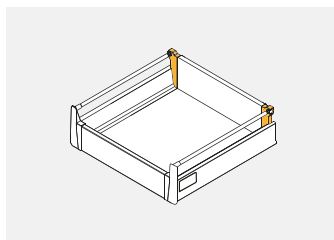

Złączka ścianki tylnej, średnia
 Back panel connector, medium
 Соединитель задней стенки, средний







			
PB-D-S2R0-00	1 kpl. = L+P 1 set = L+R	szary / gray / серый	stal steel
PB-D-S2R0-01	1 комп. = Л+П	biały / white / белый	сталь

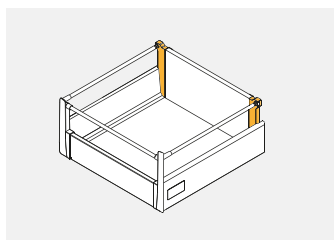
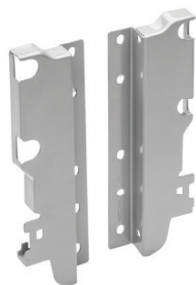

Złączka ścianki tylnej, wysoka
 Back panel connector, high
 Соединитель задней стенки, высокий



			
PB-D-W2R0-00	1 kpl. = L+P 1 set = L+R	szary / gray / серый	stal steel
PB-D-W2R0-01	1 комп. = Л+П	biały / white / белый	сталь



Mocowanie relingu do podwyższonej ścianki tylnej
 Back panel connector for rails, additional
 Соединитель задней стенки для рейлингов, дополнительная

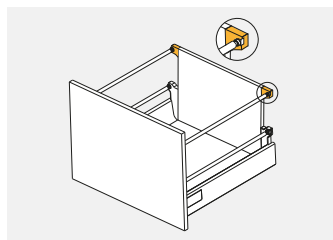





			
PB-D-D2R0-00	1 kpl. = 2 szt. 1 set = 2 pcs	szary / gray / серый	tworzywo plastic пластмасса
PB-D-D2R0-01	1 комп. = 2 шт.	biały / white / белый	



Matryca do relingów
 Marking gauge for rails
 Матрица для рейлингов







			
PB-D-MATRYCA	1 kpl. = 1 szt. 1 set = 1 pcs	szary gray серый	tworzywo plastic пластмасса



Znacznik do frontów
 Marking gauge for drawer front
 Маркер фасада







			
PB-D-ZNACZ-0	1 kpl. = 2 szt. 1 set = 2 pcs 1 комп. = 2 шт.	szary gray серый	ZnAl



Mocowanie do relingów
 Rail mounting
 Держатель рейлинга



			
PB-D-MHG04	1 kpl. = 2 szt. 1 set = 2 pcs 1 комп. = 2 шт.	szary gray серый	tworzywo plastic пластмасса



Rolka stabilizująca do szuflad push to open
 Drawer stabilizer for push to open drawers
 Стабилизирующий механизм для ящиков

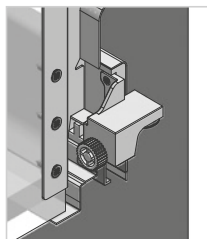

PB-D-MBSTAB-00	1 kpl. = L+P 1 set = L+R 1 комп. = Л+П	szary gray серый	tworzywo plastic пластмасса



Modern Box

Komplet szuflady piekarnikowej niskiej
 Under oven drawer set, low
 Ящик под духовку, низкий



PB-D-KPL68-450-80	450	40	szary gray серый	lakier lacquer лак	stal steel сталь
PB-D-KPL68-500-80	500		biały white белый		
PB-D-KPL68-450-10	450				
PB-D-KPL68-500-10	500				

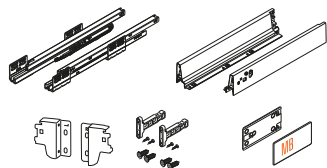

Modern Box

Komplet szuflady zlewozmywakowej niskiej
Under sink drawer – set
Ящик под мойку

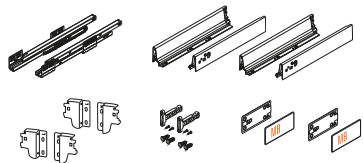

PB-D-ZLE-450	450	40	szary gray серый	lakier lacquer лак	stal steel сталь
PB-D-ZLE-500	500				

Modern Box

Komplet szuflady zlewozmywakowej U, niskiej
Under sink drawer U, low – set
Ящик под мойку U, низкий – компоненты

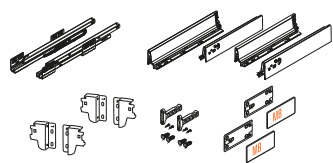



PB-D-ULE-500	500	40	szary gray серый	lakier lacquer лак	stal steel сталь

Szablon do szuflad AXIS PRO i MODERN BOX
 Template for AXIS PRO and MODERN BOX drawers
 Шаблон для ящиков AXIS PRO и MODERN BOX

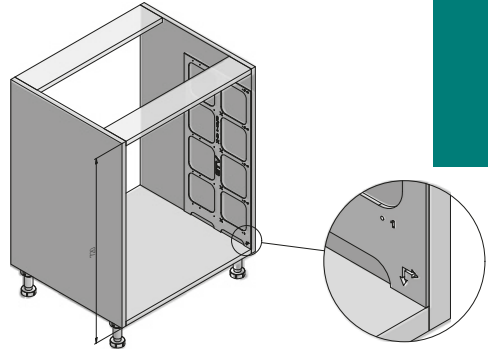
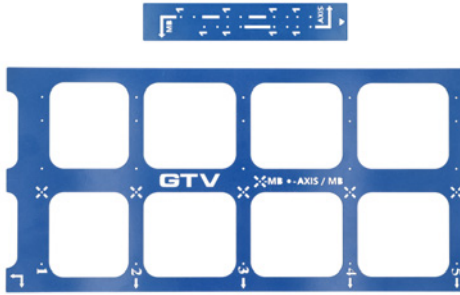
NEW



	
PB-SZABLON-AXIS-MB	stal steel сталь

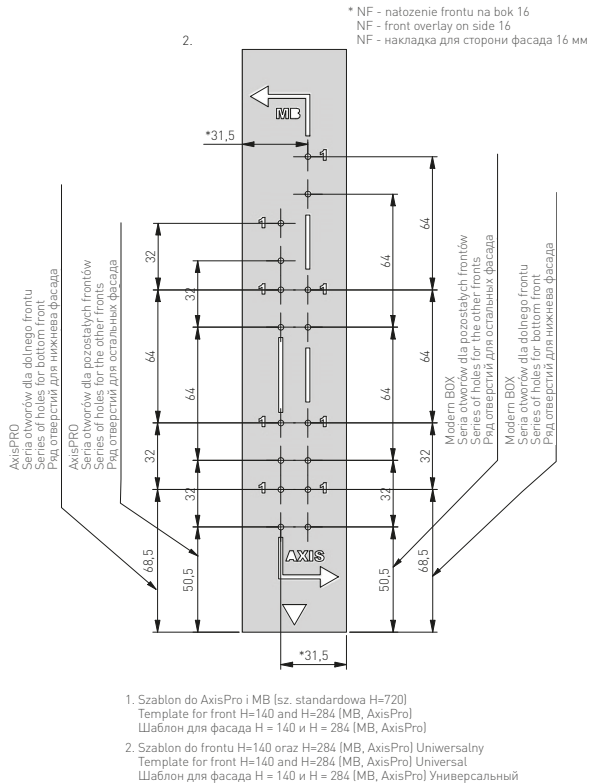
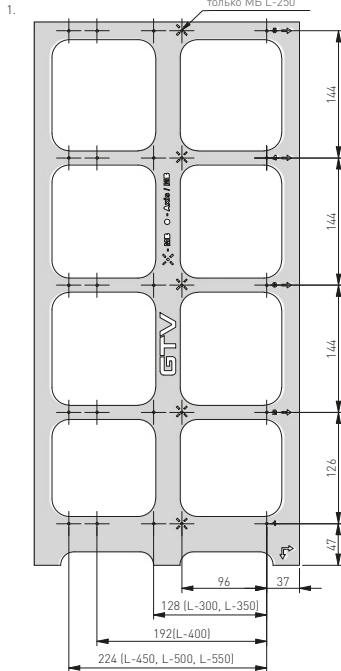

- Szablon do AxisPro i MB (sz. standardowa H=720)
Template for front H=140 and H=284 (MB, AxisPro)
Шаблон для фасада H = 140 и H = 284 (MB, AxisPro)
- Szablon do frontu H=140 oraz H=284 (MB, AxisPro) Uniwersalny
Template for front H=140 and H=284 (MB, AxisPro) Universal
Шаблон для фасада H = 140 и H = 284 (MB, AxisPro) Универсальный

Wkład CUSTOMI A regulowany
Adjustable cutlery organizer CUSTOMI A
Вкладыш CUSTOMI A с возможностью регулировки

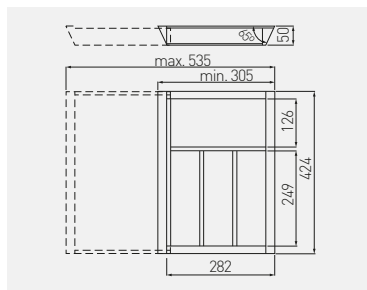

Do szuflad Modern Box i Axis PRO L = 450
 For Modern Box or Axis PRO L = 450 mm
 Подходит для ящиков Modern Box/Axis PRO L = 450 мм

Maksymalny wysuw = 535 mm
 Maximum extension = 535 mm
 Максимальное выдвижение = 535 мм

	 mm			
W-CUSTOMI-60L450	424 x 305		lakier bezbarwny matowy clearcoat matt surface лак матовый бесцветный	buk beech бук
				drewno buk beech wood дерево бука



Wkład CUSTOMI BIS A regulowany
Adjustable cutlery organizer CUSTOMI BIS A
Вкладыш CUSTOMI BIS A с возможностью регулировки

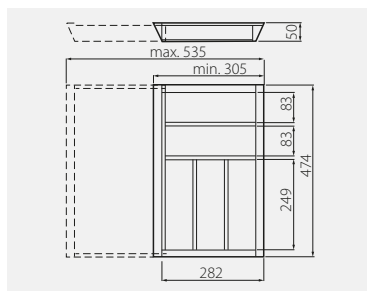

Do szuflad Modern Box i Axis PRO L = 500
 For Modern Box or Axis PRO L = 500 mm
 Подходит для ящиков Modern Box/Axis PRO L = 500 мм

Maksymalny wysuw = 535 mm
 Maximum extension = 535 mm
 Максимальное выдвижение = 535 мм

	 mm			
W-CUSTOMI-60L500	474 x 305		lakier bezbarwny matowy clearcoat matt surface лак матовый бесцветный	buk beech бук
				drewno buk beech wood дерево бука



Wkład CUSTOMI B regulowany
Adjustable cutlery organizer CUSTOMI B
Вкладыш CUSTOMI B с возможностью регулировки

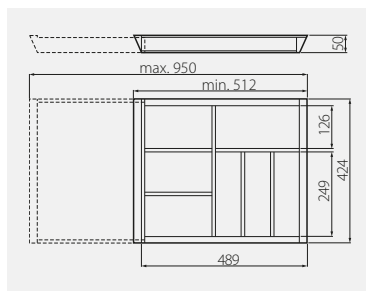

Do szuflad Modern Box i Axis PRO L = 450
For Modern Box or Axis PRO L = 450 mm
Подходит для ящиков Modern Box/Axis PRO L = 450 мм

Maksymalny wysuw = 950 mm
Maximum extension = 950 mm
Максимальное выдвижение = 950 мм

	 mm			
W-CUSTOMI-80L450	512 x 424	lakier bezbarwny matowy clearcoat matt surface лак матовый бесцветный	buk beech бук	drewno buk beech wood дерево бука



Wkład CUSTOMI BIS B regulowany
Adjustable cutlery organizer CUSTOMI BIS B
Вкладыш CUSTOMI BIS B с возможностью регулировки

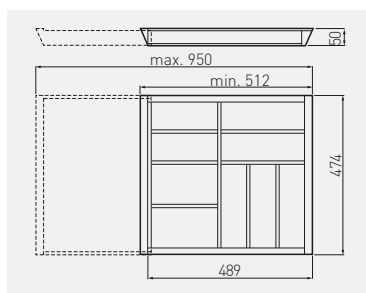

Do szuflad Modern Box i Axis PRO L = 500
For Modern Box or Axis PRO L = 500 mm
Подходит для ящиков Modern Box/Axis PRO L = 500 мм

Maksymalny wysuw = 950 mm
Maximum extension = 950 mm
Максимальное выдвижение = 950 мм





	 mm			
W-CUSTOMI-80L500	512 x 474	lakier bezbarwny matowy clearcoat matt surface лак матовый бесцветный	buk beech бук	drewno buk beech wood дерево бука



Wkład do szuflad Axispace
Cutlery organizer Axispace
Вставка в ящик Axispace

NEW



	 L mm		
WK-SZ-AS-400-10	400	biały white белый	tworzywo plastic пластмасса
WK-SZ-AS-500-10	500		
WK-SZ-AS-600-10	600		
WK-SZ-AS-800-10	800		
WK-SZ-AS-900-10	900	antracyt anthracite антрацит	
WK-SZ-AS-400-60	400		
WK-SZ-AS-500-60	500		
WK-SZ-AS-600-60	600		
WK-SZ-AS-800-60	800		
WK-SZ-AS-900-60	900		

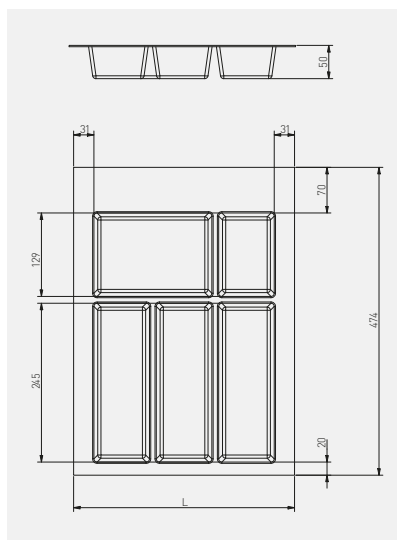

Mata antypoślizgowa AXISPACE do szuflad
Anti-slip mat for drawers AXISPACE
Противоскользящий коврик для ящиков AXISPACE

NEW

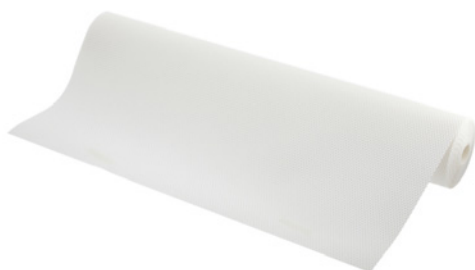

	 L mm		
MA-MATA-1-10	5000 x 480	biały / white / белый	tworzywo plastic пластмасса
MA-MATA-1-20		czarny / black / чёрный	
MA-MATA-1-60		antracyt / anthracite / антрацит	



Podpórka PELIKAN mata
Shelf support PELIKAN small
Полкодержатель PELIKAN маленький

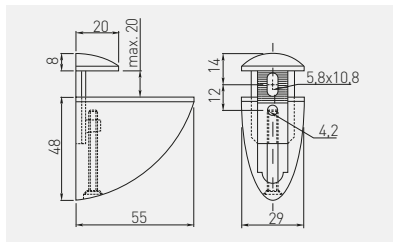

PP-MP0055-01	chrom / chrome / хром	ZnAl
PP-MP0055-02	satyna / satin / сатин	
PP-MP0055-05	aluminium / aluminium / алюминий	
PP-MP0055-06	stal szcztokowana / brushed steel / шлифованная сталь	

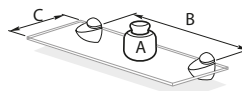

A - max. 8 kg / макс. 8 кг
B - 40 cm / 40 см
C - 20 cm / 20 см

Maksymalne obciążenie zależy od ilości wsporników i materiału, z jakiego wykonana jest półka.

The maximum load depends on the number of supports and material of which the shelf is made.

Максимальная нагрузка зависит от количества кронштейнов и материала, из которого изготовлена полка.

Podpórka PELIKAN średnia
Shelf support PELIKAN medium
Полкодержатель PELIKAN средний

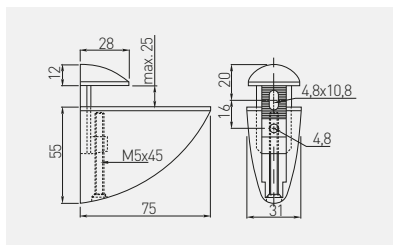

PP-SP0075-01	chrom / chrome / хром	ZnAl
PP-SP0075-02	satyna / satin / сатин	
PP-SP0075-05	aluminium / aluminium / алюминий	
PP-SP0075-06	stal szcztokowana / brushed steel / шлифованная сталь	

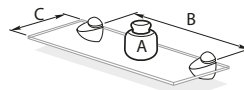

A - max. 10 kg / макс. 10 кг
B - 50 cm / 50 см
C - 25 cm / 25 см

Maksymalne obciążenie zależy od ilości wsporników i materiału, z jakiego wykonana jest półka.

The maximum load depends on the number of supports and material of which the shelf is made.

Максимальная нагрузка зависит от количества кронштейнов и материала, из которого изготовлена полка.

Podpórka PELIKAN duża Shelf support PELIKAN large Полкодержатель PELIKAN большой

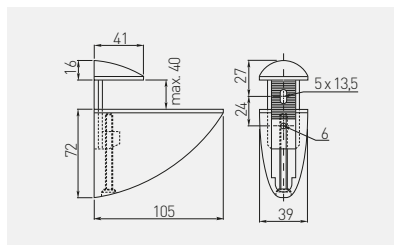

PP-DPO105-01	chrom / chrome / хром	ZnAl
PP-DPO105-02	satyna / satin / сатин	
PP-DPO105-05	aluminium / aluminium / алюминий	
PP-DPO105-06	stal szorstkowana / brushed steel / шлифованная сталь	

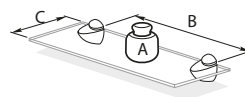

A - max. 12 kg / макс. 12 кг
B - 60 cm / 60 см
C - 30 cm / 30 см

Maksymalne obciążenie zależy od ilości wsporników i materiału, z jakiego wykonana jest półka.

The maximum load depends on the number of supports and material of which the self is made.

Максимальная нагрузка зависит от количества кронштейнов и материала, из которого изготовлена полка.

Podpórka GS02 Shelf support GS02 Полкодержатель GS02

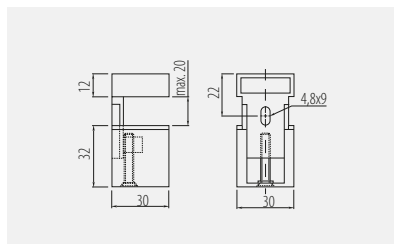

PP-00GS02-01	chrom / chrome / хром	ZnAl
PP-00GS02-02	satyna / satin / сатин	
PP-00GS02-05	aluminium / aluminium / алюминий	
PP-00GS02-06	stal szorstkowana / brushed steel / шлифованная сталь	

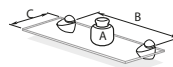

A - max. 4 kg / макс. 4 кг
B - 40 cm / см
C - 20 cm / см

Maksymalne obciążenie zależy od ilości wsporników i materiału, z jakiego wykonana jest półka.

The maximum load depends on the number of supports and material of which the shelf is made.

Максимальная нагрузка зависит от количества кронштейнов и материала, из которого изготовлена полка.

Podpórka GS03 Shelf support GS03 Полкодержатель GS03

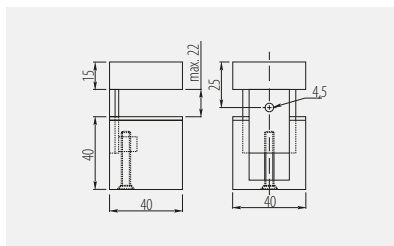

PP-00GS03-01	chrom / chrome / хром	ZnAl
PP-00GS03-02	satyna / satin / сатин	
PP-00GS03-05	aluminium / aluminium / алюминий	
PP-00GS03-06	stal szorstkowana / brushed steel / шлифованная сталь	

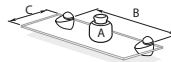

A - max. 6 kg / макс. 6 кг
B - 50 cm / см
C - 25 cm / см

Maksymalne obciążenie zależy od ilości wsporników i materiału, z jakiego wykonana jest półka.

The maximum load depends on the number of supports and material of which the shelf is made.

Максимальная нагрузка зависит от количества кронштейнов и материала, из которого изготовлена полка.



Podpórka GS04 Shelf support GS04 Полкодержатель GS04

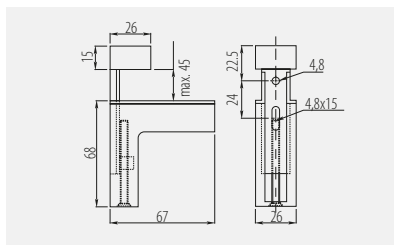

PP-00GS04-01	chrom / chrome / хром	ZnAl
PP-00GS04-02	satyna / satin / сатин	
PP-00GS04-05	aluminium / aluminium / алюминий	
PP-00GS04-06	stal szorstkowana / brushed steel / шлифованная сталь	

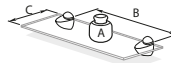

A - max. 10 kg / макс. 10 кг
B - 60 cm / см
C - 30 cm / см

Maksymalne obciążenie zależy od ilości wsporników i materiału, z jakiego wykonana jest półka.

The maximum load depends on the number of supports and material of which the shelf is made.

Максимальная нагрузка зависит от количества кронштейнов и материала, из которого изготовлена полка.



Podpórka A48 mocowana na wkręt
Shelf support A48 screw mounted
Полкодержатель A48 монтаж на винт

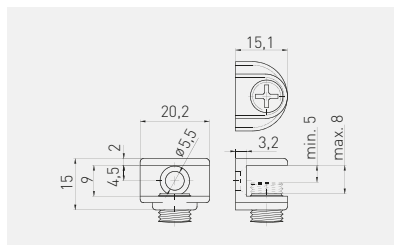

PP-GL-A48-01

chrom / chrome / хром

ZnAl



x 1000



Podpórka B48 mocowana na wcisk
Shelf support B48 plug in
Полкодержатель B48 вставной

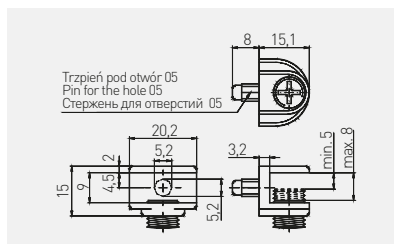

PP-GL-B48-01

chrom / chrome / хром

ZnAl



x 1000



Podpórka CGP mocowana na wkręt
Shelf support CGP screw mounted
Полкодержатель CGP монтаж на винт

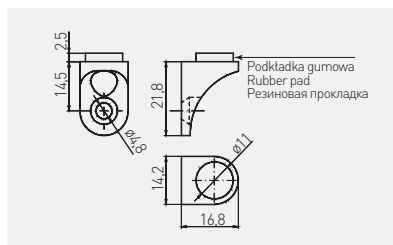

PP-GL-CGP-01	chrom / chrome / хром	ZnAl



Podpórka E410 mocowana na wcisk
Shelf support E410 plug in
Полкодержатель E410 вставной

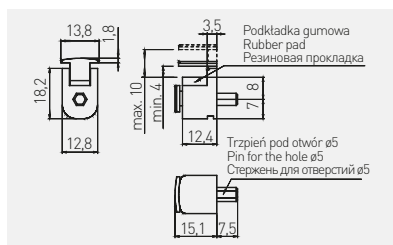

PP-GL-E410-01	chrom / chrome / хром	ZnAl





Podpórka SL3
Shelf support SL3
Полкодержатель SL3

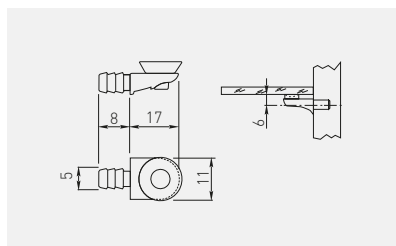

PP-S0L003-01T



chrom / chrome / хром



ZnAl, tworzywo / ZnAl, plastic / ZnAl, пластмасса



Podpórka SL12
Shelf support SL12
Полкодержатель SL12

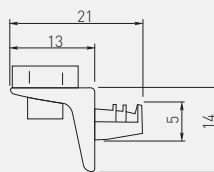

Grubość szkła max. 5 mm
Glass thickness max. 5 mm
Толщина стекла макс. 5 мм



PP-S0L012-01T



chrom / chrome / хром



ZnAl, tworzywo / ZnAl, plastic / ZnAl, пластмасса



Podpórka HS0
Shelf support HS0
Полкодержатель HS0

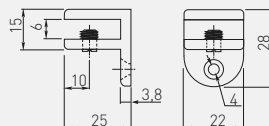

Grubość szkła max. 5 mm
Glass thickness max. 5 mm
Толщина стекла макс. 5 мм



PP-HS0006-01



chrom / chrome / хром



ZnAl



Podpórka HS2
Shelf support HS2
Полкодержатель HS2

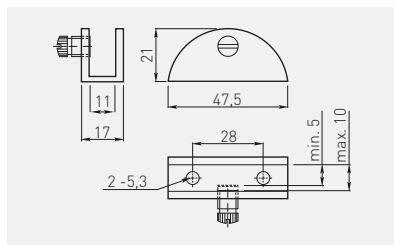

PP-HS2710-01	chrom / chrome / хром	ZnAl



Podpórka J63
Shelf support J63
Полкодержатель J63

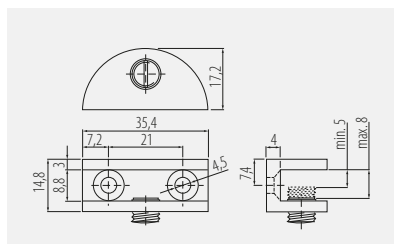



MC-J63-01	chrom / chrome / хром	ZnAl
MC-J63-05	stal szcztokowana / brushed steel / шлифованная сталь	

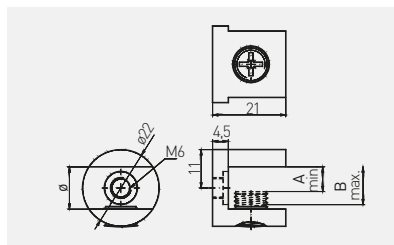

Podpórka J65
Shelf support J65
Полкодержатель J65



	\varnothing mm	A mm	B mm		
MC-J65-08-01	8	4	8	chrom / chrome / хром	ZnAl
MC-J65-08-05	8	4	8	stal szorstkowana / brushed steel / шлифованная сталь	
MC-J65-10-01	10	6	10	chrom / chrome / хром	
MC-J65-10-05	10	6	10	stal szorstkowana / brushed steel / шлифованная сталь	
MC-J65-12-01	12	7	11	chrom / chrome / хром	
MC-J65-12-05	12	7	11	stal szorstkowana / brushed steel / шлифованная сталь	



Podpórka J123
Shelf support J123
Полкодержатель J123

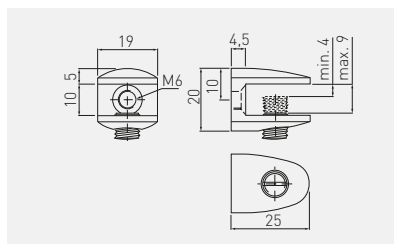

		
MC-J123-01	chrom / chrome / хром	ZnAl
MC-J123-05	stal szorstkowana / brushed steel / шлифованная сталь	



Podpórka K135
Shelf support K135
Полкодержатель K135

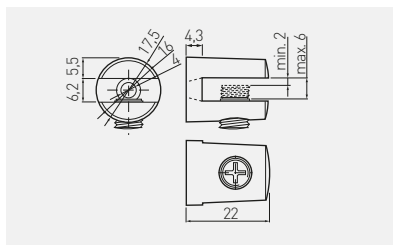

MC-K135-06-01



chrom / chrome / хром



ZnAl



Mocowanie J01
Fixture J01
Крепление J01

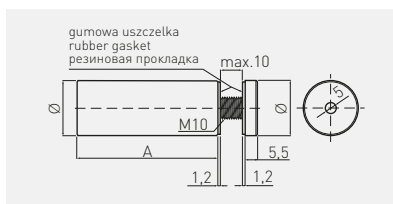

MC-J01A-12-01



mm



mm

chrom / chrome / хром



MC-J01A-12-06

12

16,5

stal szcztokowana / brushed steel / шлифованная сталь

stal
steel
сталь

160

MC-J01A-16-01

16

25

chrom / chrome / хром

MC-J01A-16-06

16

25

stal szcztokowana / brushed steel / шлифованная сталь





stal
steel
сталь

60

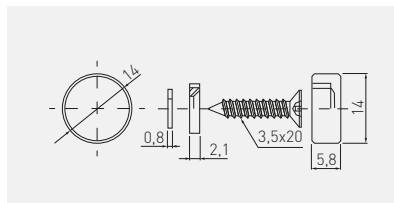

Mocowanie J04
 Fixture J04
 Крепление J04



	 mm			
MC-J04A2-14-01	14	chrom / chrome / хром	ZnAl	300
MC-J04A2-14-05	14	stal szorstkowana / brushed steel / шлифованная сталь		
MC-J04A2-18-01	18	chrom / chrome / хром		200
MC-J04A2-22-01	22	chrom / chrome / хром		100



Mocowanie J60
 Fixture J60
 Крепление J60

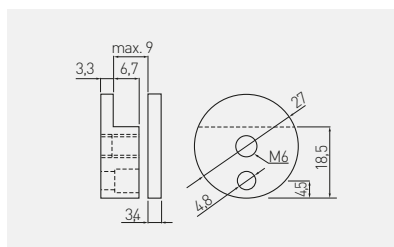

		
MC-J60A27-01	chrom / chrome / хром	ZnAl



Mocowanie J62
 Fixture J62
 Крепление J62

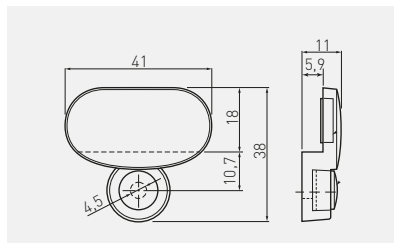

		
MC-J62-01	chrom / chrome / хром	ZnAl



Podpórka GL
 Shelf support GL
 Полкодержатель GL

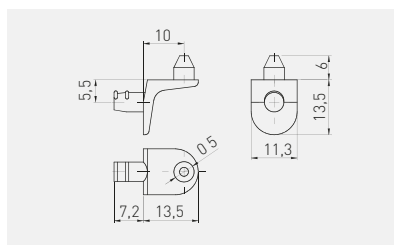

		
PP-GL-DR5-01	chrom / chrome / хром	ZnAl



Podpórka SAFETY
Shelf support SAFETY
Полкодержатель SAFETY

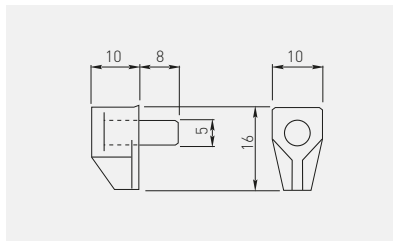

PP-SPL001-01	przeźroczysty transparent прозрачный	stal, tworzywo steel, plastic сталь, пластмасса



Podpórka MR-11
Shelf support pin MR-11
Полкодержатель MR-11

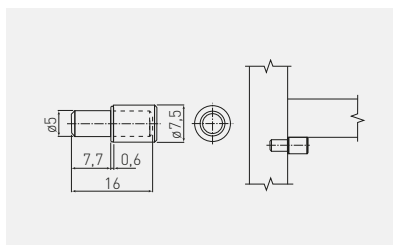

MR-ZSL011-01	z nakładką with plastic coating с накладкой	chrom / chrome / хром	stal / steel / сталь
MR-TDL011-01	bez nakładki without plastic coating без накладки		



Podpórka SMART
Shelf support SMART
Полкодержатель SMART

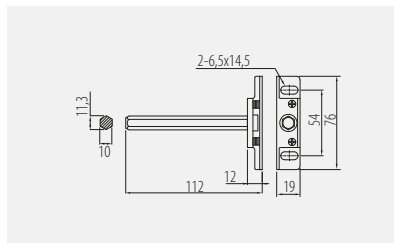

PP-SMART-000



srebrny / silver / серебристый



stal / steel / сталь



Podpórka CLEAR
Shelf support CLEAR
Полкодержатель CLEAR

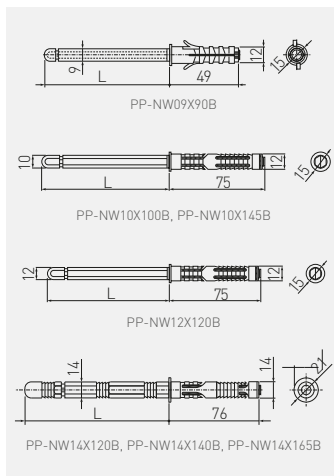

PP-NW09X90B



mm



mm



kg



PP-NW09X90B	9	90	10	brąz brown коричневый	stal steel сталь	200
PP-NW10X100B	10	110	15			
PP-NW10X145B	10	145	15			
PP-NW12X120B	12	120	15			
PP-NW14X120B	14	120	25			100
PP-NW14X140B	14	140	25			
PP-NW14X165B	14	165	25			



Podpórka LUK pod półkę
Shelf support bracket LUK
Полкодержатель LUK

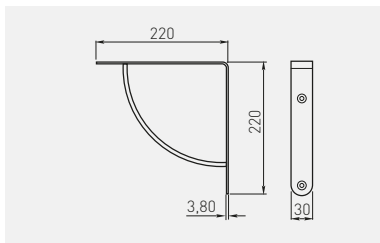

PP-LUK-00-01		30 / 2 szt.	chrom / chrome / хром	stal steel сталь
PP-LUK-00-02		30 / 2 pcs	satyna / satin / сатин	
PP-LUK-00-05		30 / 2 шт.	aluminium / aluminium / алюминий	



Podpórka WB-24 pod półkę
Shelf support bracket WB-24
Полкодержатель WB-24

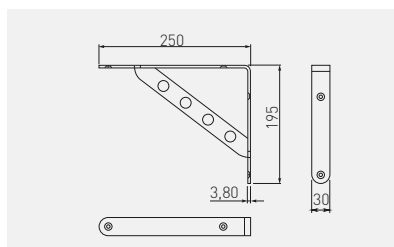

WB-073024-01		30 / 2 szt.	chrom / chrome / хром	stal / steel / сталь
WB-073024-06		30 / 2 pcs	stal szczotkowana / brushed steel / шлифованная сталь	



Podpórka WB-25 pod półkę
Shelf support bracket WB-25
Полкодержатель WB-25

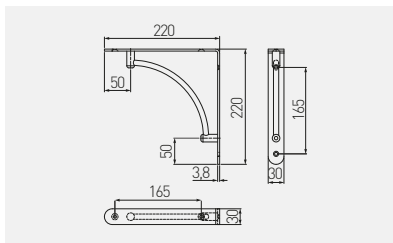

WB-073025-01	30 / 2 szt. 30 / 2 pcs	chrom / chrome / хром	stal / steel / сталь
WB-073025-06	30 / 2 шт.	stal szcztokowana / brushed steel / шлифованная сталь	



Podpórka WB-26 pod półkę
Shelf support bracket WB-26
Полкодержатель WB-26

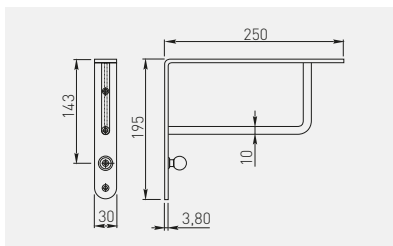

WB-073026-01	30 / 2 szt. 30 / 2 pcs	chrom / chrome / хром	stal / steel / сталь
WB-073026-06	30 / 2 шт.	stal szcztokowana / brushed steel / шлифованная сталь	



Podpórka WS12
Shelf support bracket WS12
Полкодержатель WS12

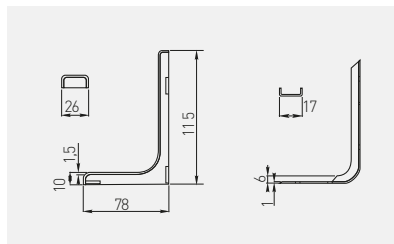

	 L mm	 kg		
WB-WS-12-010	120	8 / 2 szt. 8 / 2 pcs 8 / 2 шт.	biały / white / белый	tworzywo plastic пластмасса



Podpórka WS18
Shelf support bracket WS18
Полкодержатель WS18

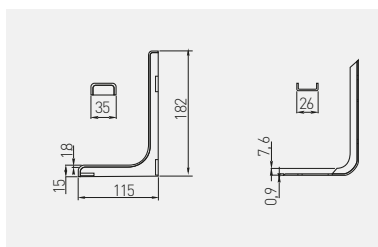

	 L mm	 kg		
WB-WS-18-010	180	9,5 / 2 szt. 9,5 / 2 pcs 9,5 / 2 шт.	biały / white / белый	tworzywo plastic пластмасса
WB-WS-18-020	180		czarny / black / чёрный	
WB-WS-18-060	180		szary / gray / серый	



Podpórka WS24
Shelf support bracket WS24
Полкодержатель WS24

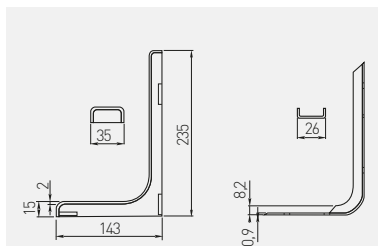

Folder	L mm	kg	Material	Material
WB-WS-24-010	240	11 / 2 szt.	biały / white / белый	tworzywo plastic пластмасса
WB-WS-24-020	240	11 / 2 pcs 11 / 2 шт.	czarny / black / чёрный	





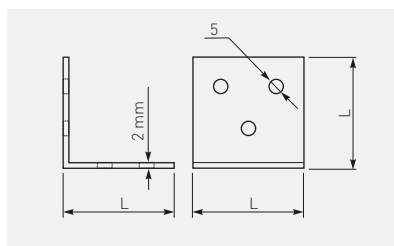



Kątownik FS01 szeroki
Angle bracket FS01
Широкий крепежный уголок FS01

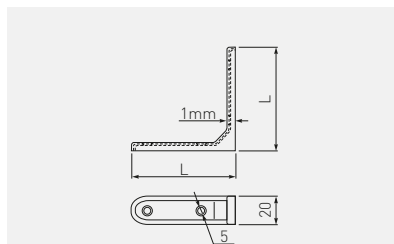

Folder	L mm	Material	Material	Weight
KW-FS0125-01	25 x 25 x 24	chrom / chrome / хром	stal / steel / сталь	1500
KW-FS0140-01	40 x 40 x 40			400





Kątownik FS03 wzmacniany
Angle bracket FS03 reinforced
Усиленный крепежный уголок FS03

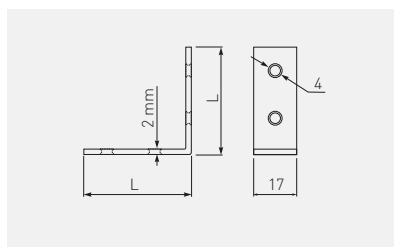

	 L mm			
KW-FS0335-01	35 x 35 x 20	chrom / chrome / хром	stal / steel / сталь	1300
KW-FS0350-01	50 x 50 x 20			700
KW-FS0375-01	75 x 75 x 20			400

Kątownik FS04 standardowy
Angle bracket FS04 standard
Стандартный крепежный уголок FS04



	 L mm			
KW-FS0425-03	25 x 25 x 17	mosiądz / brass / латунь	stal / steel / сталь	1500
KW-FS0450-03	50 x 50 x 17			600

Łątownik FS06 narożnikowy
 Corner bracket FS06
 Угловой крепежный уголок FS06

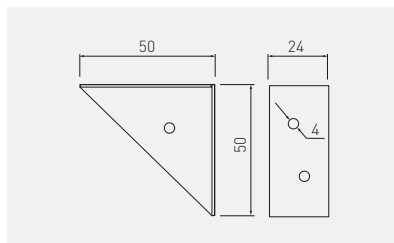

KW-FS0650-01



50 x 50 x 24



chrom / chrome / хром



stal / steel / сталь



Narożnik MONT pojedynczy
 Corner bracket MONT single
 Одинарный уголок MONT

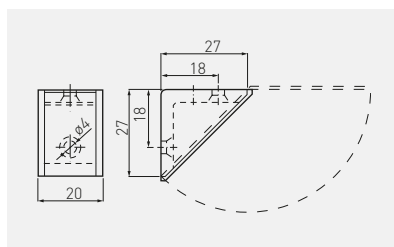

PP-PMONT0M-01*

biały / white / белый

PP-PMONT0M-07*

ciemny brąz / dark brown / темно-коричневый

PP-PMONT0M-08*

szary / gray / серый

PP-PMONT0M-22*

kość słoniowa / ivory / слоновая кость

tworzywo
plastic
пластмасса

* Produkt dostępny na indywidualne zamówienie / Available for special orders / Товар доступен под заказ

Narożnik MONT podwójny Corner bracket MONT double Двойной уголок MONT

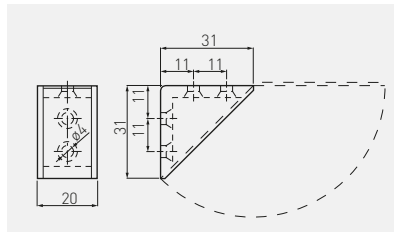

PP-PMONT0D-22*



kość stoniowa / ivory / слоновая кость

tworzywo
plastic
пластмасса

* Produkt dostępny na indywidualne zamówienie / Available for special orders / Товар доступен под заказ

Narożnik NARS pojedynczy Corner bracket NARS single Одинрный уголок NARS

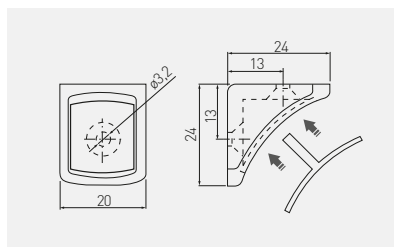

PM-NAR1003-11

kość stoniowa / ivory / слоновая кость



PM-NAR1003-19

szary / gray / серый

tworzywo
plastic
пластмасса

PM-NAR1003-10



biały / white / белый

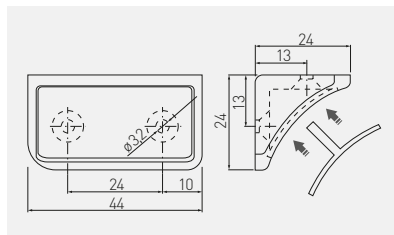

* Produkt dostępny na indywidualne zamówienie / Available for special orders / Товар доступен под заказ

Narożnik NARS podwójny Corner bracket NARS double Двойной уголок NARS







		
PM-NAR1004-11	kość stoniowa / ivory / слонобая кость	tworzywo plastic пластмасса
PM-NAR1004-19	szary / gray / серый	
PM-NAR1004-10	biały / white / белый	

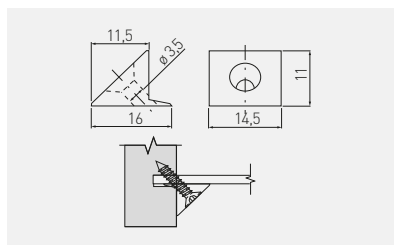

* Produkt dostępny na indywidualne zamówienie / Available for special orders / Товар доступен под заказ

Stabilizator ścianki tylnej Rear stabilizer Стабилизатор задней стенки



			
WZ-SCTYLPR-WK	z wkrętem 3,5 x 20 with screw 3,5 x 20 с шурупом 3,5 x 20	transparentny transparent прозрачный	tworzywo plastic пластмасса
WZ-SCTYLPR-BWK	bez wkręta without screw без шурупа		



Zawieszka niewidoczna FORCE
 Invisible kitchen hanger FORCE
 Скрытый навес FORCE

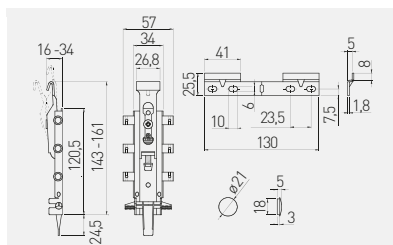

ZK-FORCE-KPL	100 / 2 szt. 100 / 2 pcs 100 / 2 шт.	srebrny / silver / серебристый	ZnAl, stal / ZnAl, steel / ZnAl, сталь



Zawieszka kuchenna R0 z regulacją
 Kitchen hanger R0 adjustable
 Навес кухонный R0 с регулировкой

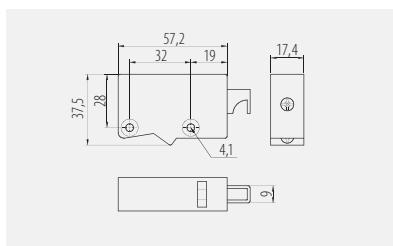





ZK-ZAW-R0-10	95 / 2 szt. 95 / 2 pcs	biały / white / белый	stal, tworzywo steel, plastic
ZK-ZAW-R0-30	95 / 2 szt.	brąz / brown / коричневый	stal, plastmasa steel, plastic

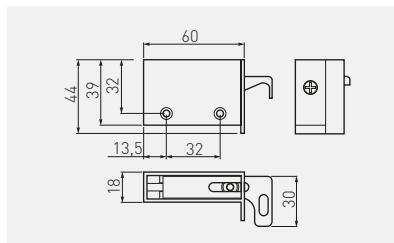

Zawieszka kuchenna R1
Kitchen hanger R1
Навес кухонный R1







			
ZK-R1-KPL-10	110 / 2 szt. 110 / 2 pcs 110 / 2 шт.	biały / white / белый	stal, tworzywo steel, plastic сталь, пластмасса

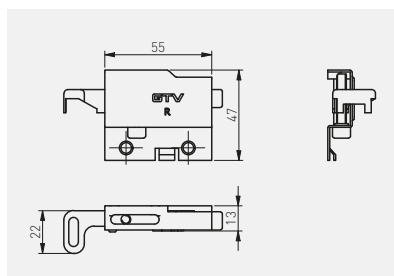

Zawieszka meblowa FORZA
Cabinet hanger FORZA
Навес FORZA



				
ZK-FORZA-ZAW-KPL	150 / 2 szt. 150 / 2 pcs 150 / 2 шт.	1 kpl. = L+P 1 set = L+R 1 комп. = Л+П	srebrny silver серебристый	stal, tworzywo steel, plastic сталь, пластмасса



Zaślepka do zawieszki FORZA
Hanger caps FORZA
Заглушки для навесов FORZA

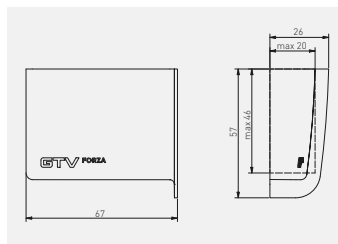





			
ZK-FORZA-ZAS-KPL-010	1 kpl. = L+P 1 set = L+R	biały / white / белый	tworzywo plastic пластмасса
ZK-FORZA-ZAS-KPL-020	1 комп. = Л+П	czarny / black / чёрный	

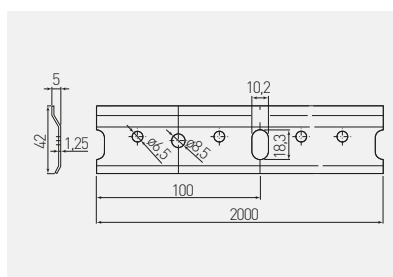

Listwa montażowa
Mounting strip
Монтажная планка



			
LO-M2M-00-125	2000 mm	ocynk galvanized гальваника	stal steel сталь



Złącze do blatów śrubowe
 Concealed worktop connector
 Стяжка для столешниц

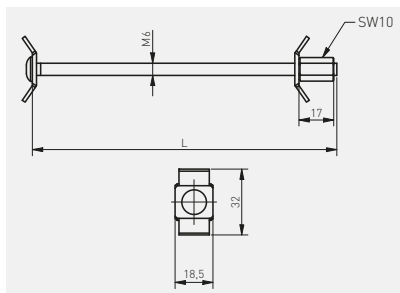





	 L mm		
EM-SBL065-01-A	65	chrom / chrome / хром	stal / steel / сталь
EM-SBL100-01-A	100		
EM-SBL150-01-A	150		

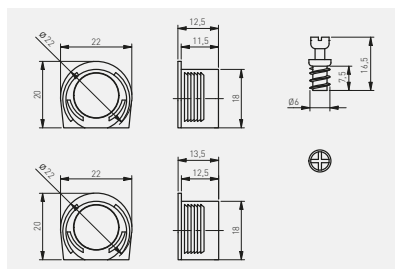

Złącze mimośrodkowe do półek
 Eccentric connecting fitting for shelves
 Эксцентриковая стяжка для полок



	 Ø mm			
MM-FI20X6X7-PL10-A-1T	20	trzcień 6 x 16,5 mm dowel 6 x 16,5 mm штифт 6 x 16,5 mm	biały / white / белый	ZnAl, tworzywo ZnAl, plastic ZnAl, пластмасса
MM-FI20X6X7-PL20-A-1T			czarny / black / чёрный	
MM-FI20X6X7-PL30-A-1T			brąz / brown / коричневый	
MM-FI20X6X7-PL80-A-1T			szary / gray / серый	
MM-FI20X6X7-ZN-A-1T			srebrny / silver / серебристый	



Szybkozłącze

Threaded sleeve, with internal thread

Стяжки







SZ-005-00-01T
SZ-008-00-01T

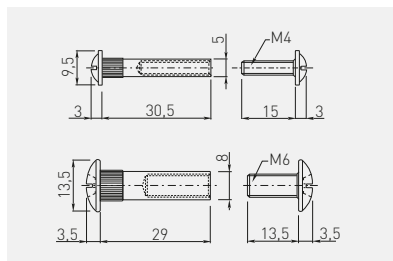

SZ-005-00-01-AT
SZ-008-00-01-AT



		 mm		
SZ-005-00-01T		5	chrom / chrome / хром	stal / steel / сталь
SZ-005-00-01-AT				
SZ-008-00-01T	8			
SZ-008-00-01-AT				









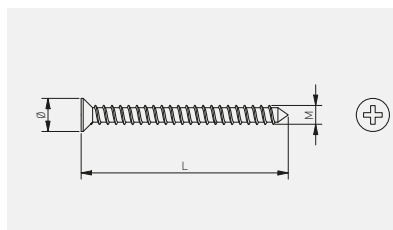

Wkręt do drewna

Screw for wood

Мебельные метизы



		 mm		
WK-D0320-001*		3 x 20	chrom chrome хром	stal steel сталь
WK-D0325-001*		3 x 25		
WK-D0330-001*		3 x 30		
WK-D0416-001		4 x 16		
WK-D0425-001*		4 x 25		

		 mm		
WK-D0430-001		4 x 30	chrom chrome хром	stal steel сталь
WK-D0440-001*		4 x 40		
WK-D0460-001*		4 x 60		
WK-D3516-001		3,5 x 16		
WK-D3530-001		3,5 x 30		

* Produkt dostępny na indywidualne zamówienie / Available for special orders / Товар доступен под заказ



Mimośród
Eccentric connecting fitting
Эксцентрик

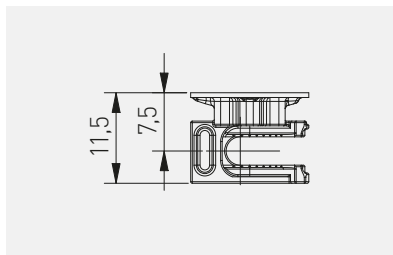

Folder	mm	Color	Material
WK-CAM-15-12-D	Ø15 x 12	srebrny / silver / серебряный	ZnAl
WK-CAM-15-13-D*	Ø15 x 13		



*

Trzpień do mimośródu
Bolt for eccentric connecting fitting
Шток эксцентрика

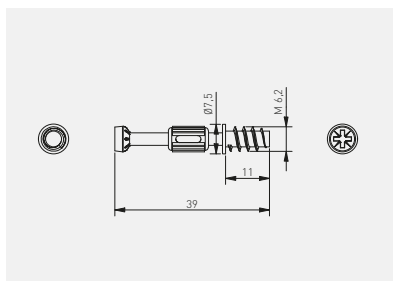

Folder	mm	Color	Material
WK-DOW63X45B-D	6,3 x 45	srebrny, czarny silver, black серебряный, чёрный	stal, tworzywo steel, plastic сталь, пластмасса
WK-DOW63X39-D	6,3 x 39	srebrny, czerwony silver, red серебряный, красный	
WK-DOW63X35B-D	6,3 x 35	srebrny, zielony silver, green серебряный, зеленый	
WK-DOW63X31G-D	6,3 x 31		



Komplet mimośród i trzpień
Set of eccentric connecting fitting and bol
Комплект эксцентрик и дюбель



	 mm		
WK-CAM-15-DOW63X45-KPL-1T	6,3 x 45	srebrny, czarny silver, black серебряный, чёрный	stal, tworzywo, ZnAl steel, plastic, ZnAl сталь, пластмасса, ZnAl
WK-CAM-15-DOW63X39-KPL-1T	6,3 x 39	srebrny, czerwony silver, red серебряный, красный	
WK-CAM-15-DOW63X35-KPL-1T	6,3 x 35	srebrny, zielony silver, green серебряный, зеленый	
WK-CAM-15-DOW63X31-KPL-1T	6,3 x 31	srebrny, zielony silver, green серебряный, зеленый	



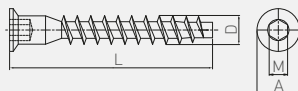

* Produkt dostępny na indywidualne zamówienie / Available for special orders / Товар доступен под заказ

Konfirmat
Konfirmat screw
Конфирмат



	L	D	A	M	
WK-CF6450-01	6,4 x 50	50	6,4	9,5	4
WK-CF0750-01	7 x 50	50	7	10	4



		
WK-CF6450-01*	chrom / chrome / хром	stal / steel / сталь
WK-CF0750-01*		

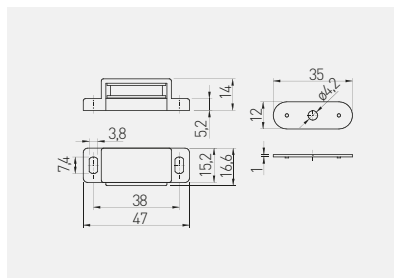

* Produkt dostępny na indywidualne zamówienie / Available for special orders / Товар доступен под заказ

Magnes MENSA
Magnetic catch MENSA
Магнит MENSA



		
MG-MENSA-010	biały / white / белый	stal, tworzywo steel, plastic сталь, пластмасса
MG-MENSA-030	brąz / brown / коричневый	



Profil meblowy PFM – typ H
Furniture edge profile PFM – type H
Мебельный профиль PFM – тип H

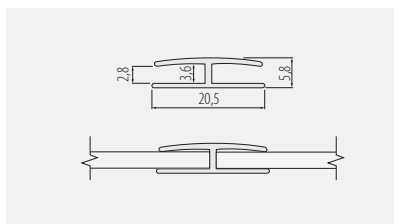

			
PM-PFMH51-10*	2000	ciemny brąz / dark brown / темно-коричневый	tworzywo plastic пластмасса
PM-PFMH61-10*	2000	ciemny mahoń / dark mahogany / темное красное дерево	
PM-PFMH50-24*	2400	biały / white / белый	
PM-PFMH50-25*	2500	biały / white / белый	
PM-PFMH55-25*	2500	czarny / black / чёрный	
PM-PFMH64-25*	2500	mahoń / mahogany / красное дерево	



Listwa ozdobna płaska
Flat decorative strip
Плоская декоративная планка

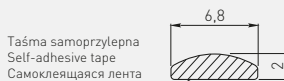

Taśma samoprzylepna
Self-adhesive tape
Самоклеющаяся лента

	 L mm		
LO-00-00-001*	2000	chrom / chrome / хром	tworzywo plastic пластмасса
LO-00-00-003	2000	mosiądz / brass / латунь	



* Produkt dostępny na indywidualne zamówienie / Available for special orders / Товар доступен под заказ

Listwa boczna 38
Worktop edging strip 38
Торцевая планка 38

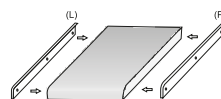

Do blatów o grubości 38 mm
For worktops 38 mm thick
Для столешниц толщиной 38 мм

		 L mm		
LMB-BOCZ38L-05	lewa / left / левая	600	aluminium / aluminium / алюминий	aluminium aluminium алюминий
LMB-BOCZ38L-20M			czarny / black / чёрный	
LMB-BOCZ38P-05	prawa / right / правая		aluminium / aluminium / алюминий	
LMB-BOCZ38P-20M			czarny / black / чёрный	



Listwa kątowa 38
Worktop angle edging strip 38
Угловая планка 38

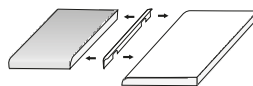

Do blatów o grubości 38 mm
For worktops 38 mm thick
Для столешниц толщиной 38 мм



LMB-KAT38-05	600	aluminium / aluminium / алюминий	aluminium aluminium алюминий
LMB-KAT38-20M		czarny / black / чёрный	



* Produkt dostępny na indywidualne zamówienie / Available for special orders / Товар доступен под заказ



Listwa szczelinowa 38 mm
Worktop joining strip 38 mm
Щелевая планка 38 mm

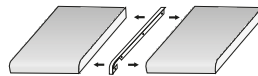

Do blatów o grubości 38 mm
For worktops 38 mm thick
Для столешниц толщиной 38 мм

	 L mm		
LMB-SZCZ38-05	600	aluminium / aluminium / алюминий	aluminium aluminium алюминий
LMB-SZCZ38-20M		czarny / black / чёрный	



Drażek owalny
Oval wardrobe rail
Овальная труба для гардероба

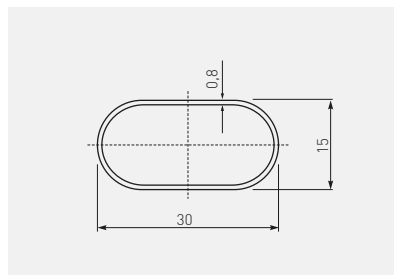

	 L mm		
RR-CH-OW-000	3000	chrom / chrome / хром	stal / steel / сталь



Mocowanie RDR do drążka owalnego
 RDR mounting bracket for oval wardrobe rail
 Крепление RDR для овальной трубы

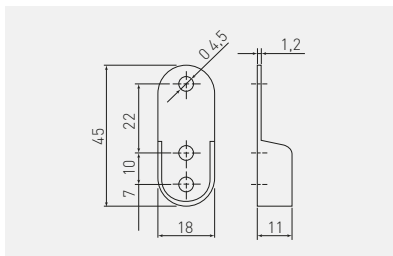

MR-RDRO-0000



chrom / chrome / хром



stal / steel / сталь



Uchwyt WP-28 do rury owalnej
 WP-28 angle bracket for oval rail
 Крепление дистанционное для овальной трубы WP-28

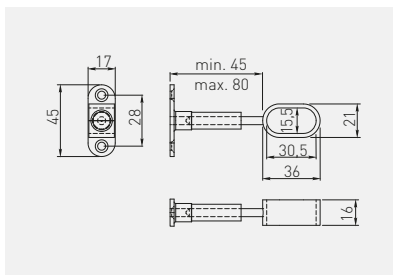

MR-WP-028-01



chrom / chrome / хром





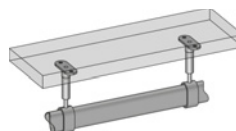



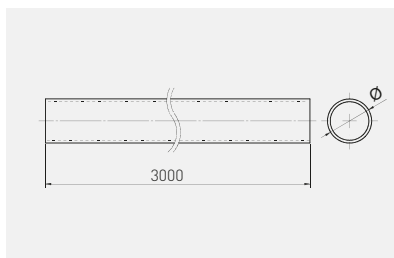

ZnAl



Drażek okrągły
Round wardrobe rail
Мебельная штанга



		 mm	 mm	 mm		
RR-161030H01		16	1	3000	chrom chrome хром	stal steel сталь
RR-161230H01		16	1,2			
RR-250730H01		25	0,7			
RR-250830H01		25	0,8			
RR-250930H01		25	0,9			

		 mm	 mm	 mm		
RR-251030H01		25	1	3000	chrom chrome хром	stal steel сталь
RR-401230H01*		40	1,2			
RR-501030H01		50	1			
RR-501230H01		50	1,2			



* Produkt dostępny na indywidualne zamówienie / Available for special orders / Товар доступен под заказ

Mocowanie R-25 do drążka okrągłego
R-25 mounting bracket for round rail
Крепление R-25 для трубы

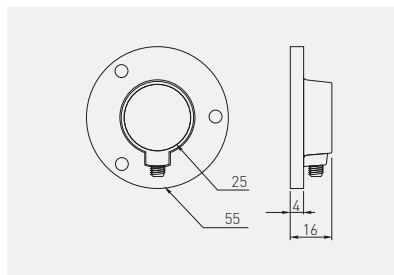





		 mm		
MR-RS025-001		25	chrom / chrome / хром	stal / steel / сталь

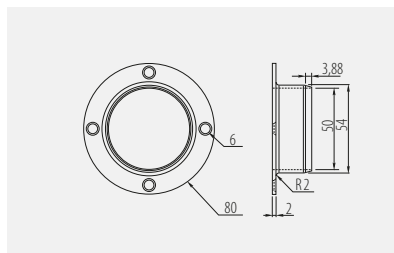

Mocowanie R-50 do drążka okrągłego
R-50 mounting bracket for round rail
Крепление R-50 для трубы



	 mm		
MR-R0050-001	50	chrom / chrome / хром	stal / steel / сталь



Mocowanie PZ-2 dolne do drążka okrągłego
PZ-2 bottom mounting bracket for round rail
Нижнее крепление PZ-2 для трубы

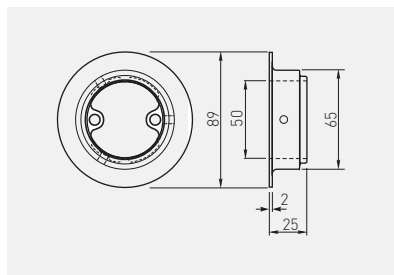

	 mm		
MR-WPZ002-01	50	chrom / chrome / хром	stal / steel / сталь



Pierścień mocujący PZ-3
 Mounting ring PZ-3
 Крепёжное кольцо PZ-3

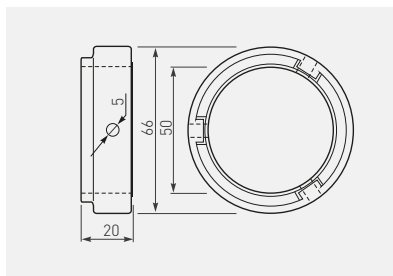

	 mm		
MR-WPZ003-01	50	chrom / chrome / хром	ZnAl



Uchwyt WP-10 dystansowy, regulowany
 WP-10 support bracket, adjustable
 Регулируемый кронштейн WP-10

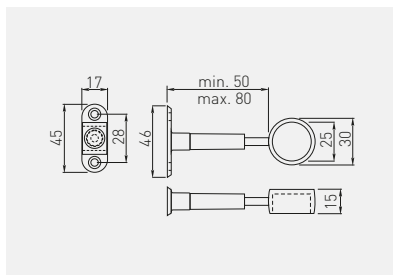

	 mm		
MR-WP-010-01	25	chrom / chrome / хром	ZnAl



Uchwyt WP-11 dystansowy, regulowany z zaślepką
 WP-11 support bracket, adjustable with cover
 Регулируемый кронштейн WP-11 с заглушкой

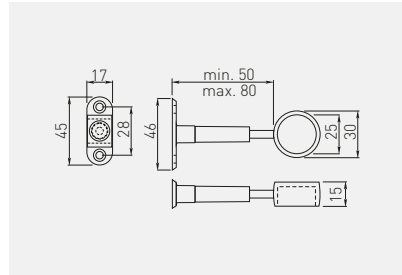

	 mm		
MR-WP-011-01	25	chrom / chrome / хром	ZnAl



Uchwyt THA-12 dystansowy, przelotowy
 THA-12 support bracket
 Опорный кронштейн THA-12 сквозной

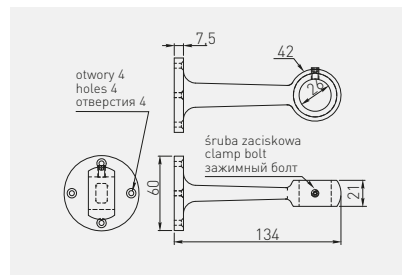

	 mm		
MR-THA12-001	25	chrom / chrome / хром	ZnAl



Uchwyt THB-12 dystansowy
 THB-12 support bracket
 Опорный кронштейн THB-12

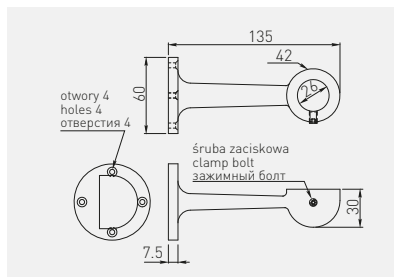

	 mm		
MR-THB12-001	25	chrom / chrome / хром	ZnAl

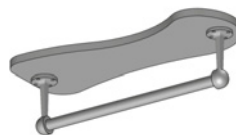

Łącznik WP-13
 WP-13 connector
 Соединитель WP-13

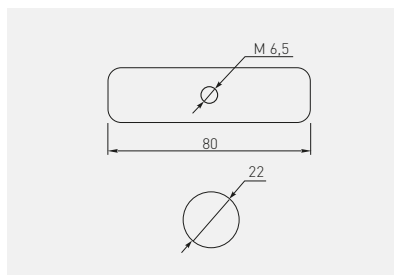

		
MR-WP013-001	osynk / galvanized / гальваника	ZnAl



Złącze TH-5 dwuramienne
 TH-5 connector
 Муфта TH-5 двухраструбная

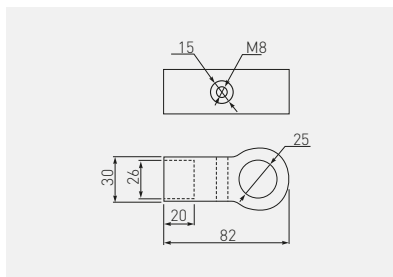

			
MR-TH005-001	25	chrom / chrome / хром	ZnAl



Złącze TH-16 dwuramienne
 TH-16 connector
 Муфта двухраструбная TH-16

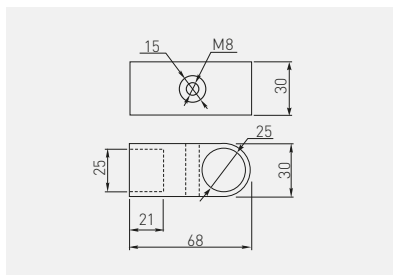

			
MR-TH016-001	25	chrom / chrome / хром	ZnAl



Złącze TH-4 dwuramiennie typ T
 TH-4 connector type T
 Муфта TH-4 двухраструбная тип T

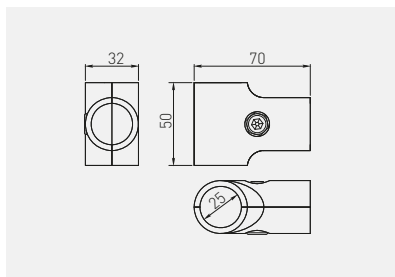

	 mm		
MR-TH004-001	25	chrom / chrome / хром	ZnAl



Zestaw złączy TH-18 typ L
 TH-18 connector type L
 Набор муфт TH-18 тип L

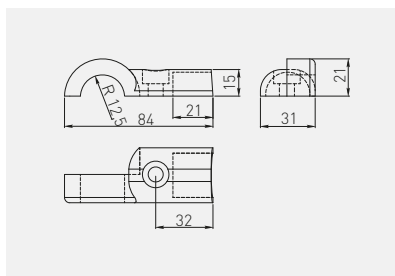

Możliwość uzyskania różnych pozożeń połączenia
 The possibility of obtaining various positions of connection
 Возможность получения разных положений соединения

		 mm		
MR-TH018-KPL	prawy / lewy right / left правый / левый	25	chrom / chrome / хром	ZnAl



Zestaw złączy T-18 typ T
T-18 connectors set type T
Набор муфт ТН-18 тип Т

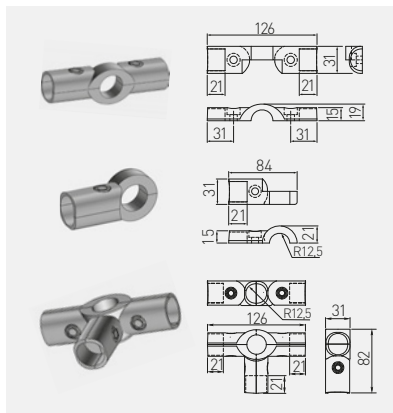

	 mm		
MR-T1824-KPL	25	chrom / chrome / хром	ZnAl

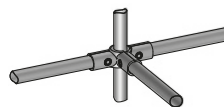

Zestaw złączy TH-24
TH-24 connectors set
Набор муфт ТН-24

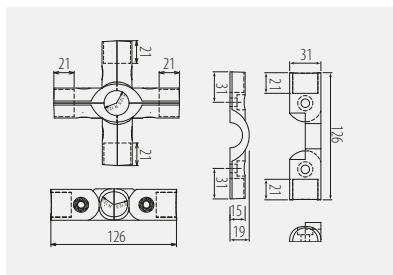

	 mm		
MR-TH024-KPL	25	chrom / chrome / хром	ZnAl



Złącze TH-11 zawiasowe
TH-11 hinge connector
Муфта шарнирная TH-11

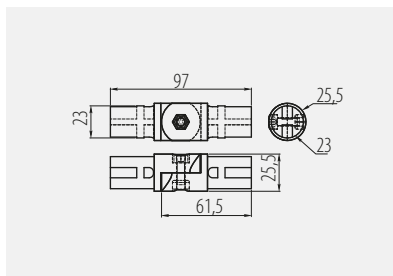

Możliwość dostosowania kąta złączy do założonego położenia (do 180°)

The possibility of adjustment of angle connector arms to the desired position (up to 180°)

Возможность регулировки угла стыковки соединителей к заданному положению [180°]

MR-TH011-001	chrom / chrome / хром	ZnAl



Złącze TH-9
TH-9 connector
Муфта TH-9

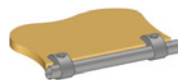
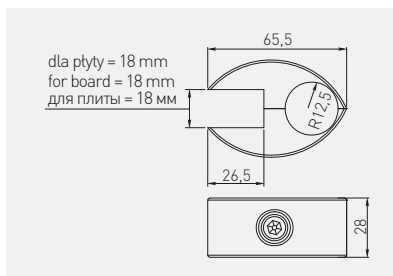

MR-TH009-001	chrom / chrome / хром	ZnAl



Zalecana grubość szkła z użyciem wkładek: 4-8 mm
Recommended glass thickness with inserts: 4-8 mm
Рекомендуемая толщина стекла с использованием вкладышей: 4-8 мм

Złącze TH-10 dwustronne
TH-10 connector
Муфта TH-10 двухсторонняя

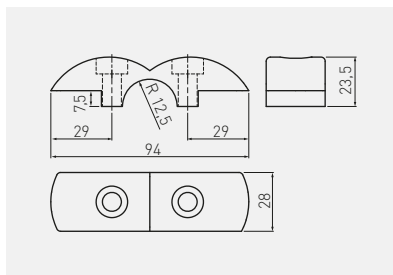

MR-TH010-001	chrom / chrome / хром	ZnAl



Zalecana grubość szkła z użyciem wkładek: 4-8 mm
Recommended glass thickness with inserts: 4-8 mm
Рекомендуемая толщина стекла с использованием вкладышей: 4-8 мм

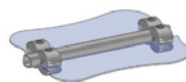

Zestaw złączy TH-35
TH-35 set of connectors
Набор муфт TH-35

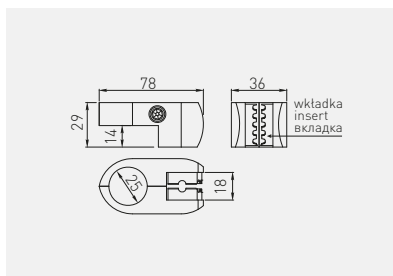

MR-TH035-KPL	25	chrom / chrome / хром	ZnAl



Zalecana grubość szkła z użyciem wkładek: 4-8 mm
Recommended glass thickness with inserts: 4-8 mm
Рекомендуемая толщина стекла с использованием вкладышей: 4-8 мм

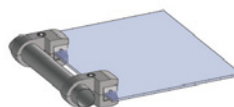

Złącze WP-14 dwustronne
WP-14 connector
Муфта WP-14 двухсторонняя

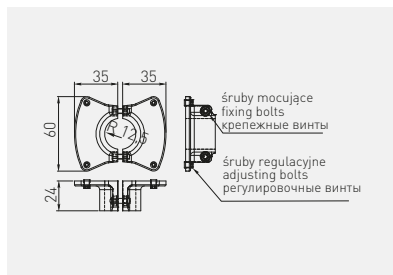

MR-WP-14-KPL	25 mm	chrom / chrome / хром	ZnAl

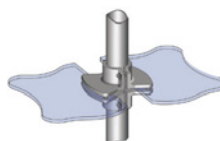

Złącze WP-15
WP-15 connector
Муфта WP-15



MR-WP-15-KPL	25 mm	chrom / chrome / хром	ZnAl

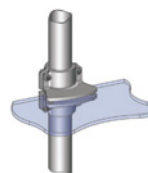

Złącze TH-1 równoległe
 TH-1 connector parallel
 Муфта TH-1 равнопроходная

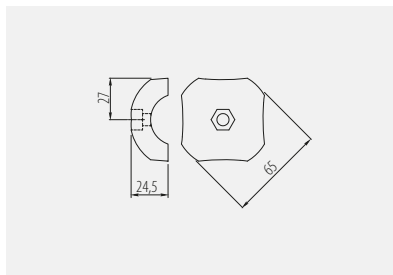

		
MR-TH001-01	chrom / chrome / хром	ZnAl



Złącze TH-2 potrójne
 TH-2 connector three-way
 Муфта TH-2 тройная

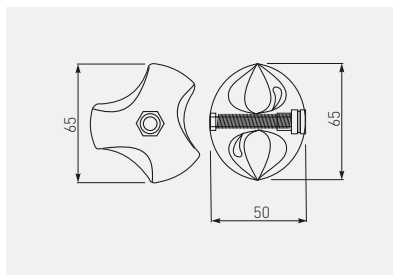

			
MR-TH002-L01	lewy / left / левый	chrom / chrome / хром	ZnAl
MR-TH002-P01	prawy / right / правый		



Złącze TH-18 podwójne
TH-18 double connector
Муфта TH-18 двойная

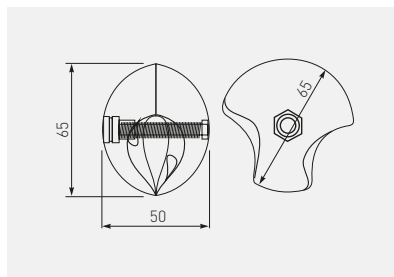

MR-TH018-L01	lewy / left / левый	chrom / chrome / хром	ZnAl
MR-TH018-P01	prawy / right / правый		



Zaślepka okrągła
Round end cap
Круглая заглушка

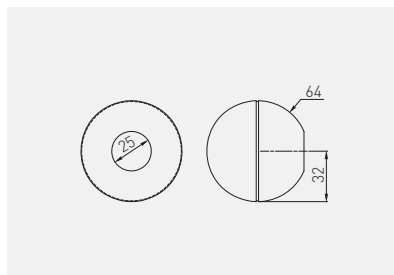

MR-THQZ1-001	25	chrom / chrome / хром	ZnAl



Zaślepka TH-19
 TH-19 end cap
 Заглушка TH-19

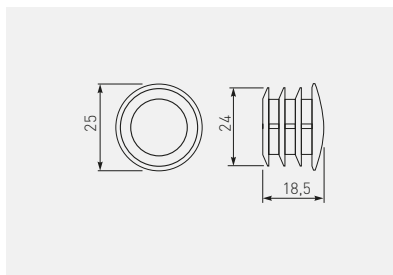

	 mm		
MR-TH019-001	25	chrom / chrome / хром	ZnAl



Stopka plastikowa zewnętrzna
 Plastic end cap
 Внешняя ножка, пластмассовая

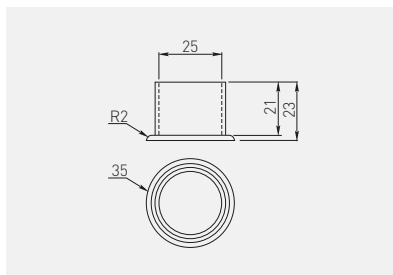

	 mm		
MR-TH019-003	25	czarny black чёрный	tworzywo plastic пластмасса



Uchwyt THA-48 z przyssawką
 THA-48 handle with suction cup
 Крепление THA-48 с присоской

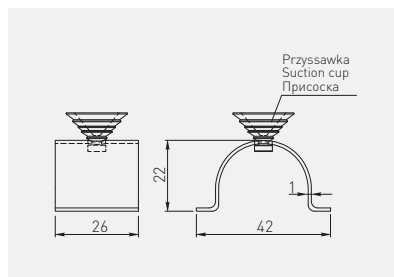

	 mm		
MR-TH048-001	25	chrom chrome хром	stal, tworzywo steel, plastic сталь, пластмасса

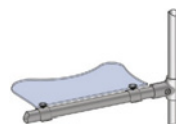

Mocowanie PZ-6 górne, rozporowe
 PZ-6 expandable end support bracket
 Верхнее крепление PZ-6

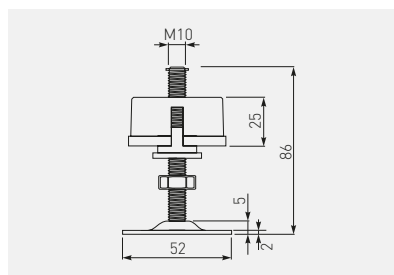

	 mm		
MR-WPZ006-01	50	chrom / chrome / хром	stal, tworzywo / steel, plastic / сталь, пластмасса



Uchwyt do relingu prosty
 Rail support
 Ручка для рейлинга прямая

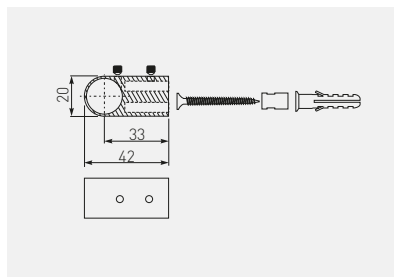

	 mm		
MR-WP2802-01	16	chrom / chrome / хром	ZnAl



Zaślepka do relingu prosta
 End cap
 Заглушка для рейлинга прямая

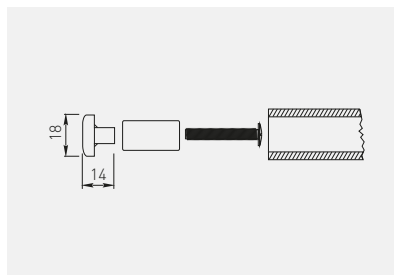

	 mm		
MR-WP2815-01	16	chrom / chrome / хром	ZnAl



Uchwyt do relingu
Rail support
Ручка для рейлінга

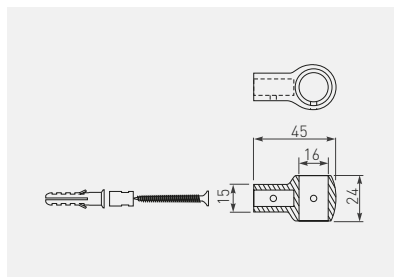

	 mm		
MR-WP2804-01	16	chrom / chrome / хром	ZnAl



Zaślepka do relingu
End cap
Заглушка для рейлінга

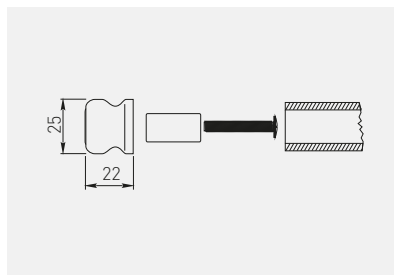

	 mm		
MR-WP2806-01	16	chrom / chrome / хром	ZnAl, tworzywo / ZnAl, plastic / ZnAl, пластмасса



Łącznik do relingu
 Rail connector
 Соединитель для рейлинга

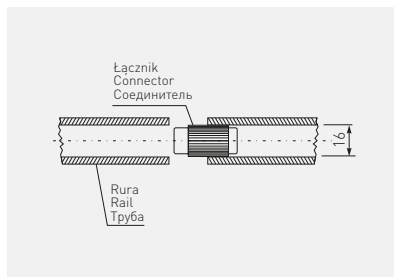

	 mm		
MR-WP2807-20	16	czarny / black / чёрный	tworzywo / plastic / пластмасса



Zaślepka do relingu z gwintem
 End cap with thread for rails
 Заглушка для рейлинга с резьбой

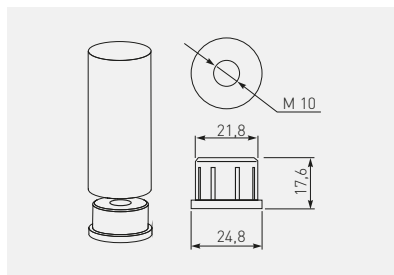

		
MR-WPZ023-01	chrom / chrome / хром	ZnAl



Начыкі до релінгу PS1
 Hooks for rails PS1
 Крючки для рейлінга PS1

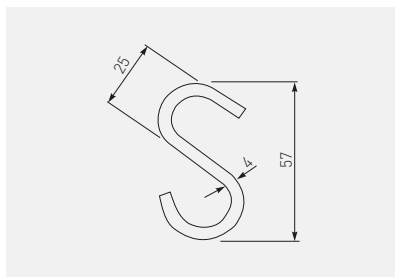

	 mm		
MR-WPS01-001	16	chrom / chrome / хром	stal / steel / сталь



Начыкі до релінгу PS3
 Hooks for rails PS3
 Крючки для рейлінга PS3

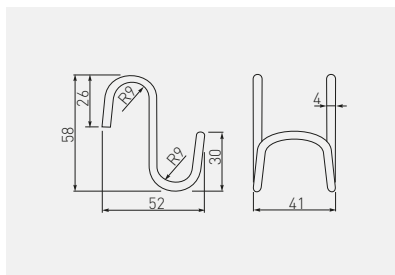





	 mm		
MR-WPS03-001	16	chrom / chrome / хром	stal / steel / сталь

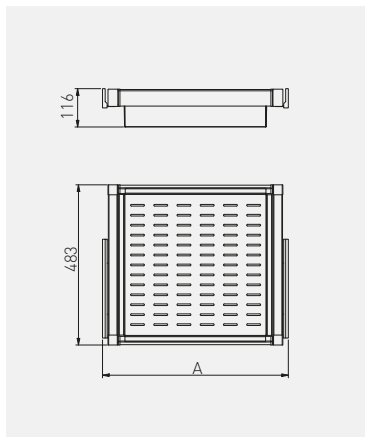

Kosz metalowy ELITE
 Metal basket ELITE
 Металлическая корзина ELITE





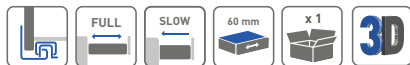

	A min./max.			
WG-KOSZM60-10	560 - 618	pełny full полное	biały white белый	stal, tworzywo steel, plastic сталь, пластмасса
WG-KOSZM70-10	660 - 718			
WG-KOSZM80-10	760 - 818			
WG-KOSZM90-10	860 - 918			
WG-KOSZM60-60	560 - 618		antracyt anthracite антрацит	
WG-KOSZM70-60	660 - 718			
WG-KOSZM80-60	760 - 818			
WG-KOSZM90-60	860 - 918			

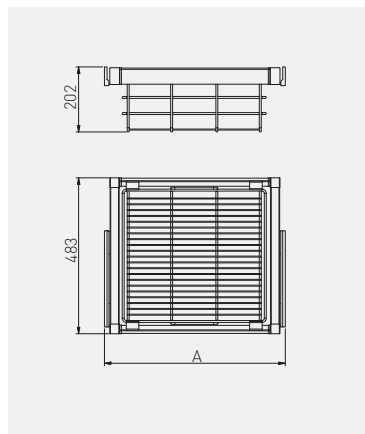

Kosz ażurowy ELITE
Openwork basket ELITE
Ажурная корзина ELITE





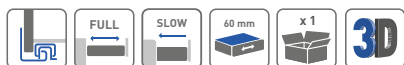

	A min./max.			
WG-KOSZ60-10	560 - 618	pełny full полное	biały white белый	stal, tworzywo steel, plastic сталь, пластмасса
WG-KOSZ70-10	660 - 718			
WG-KOSZ80-10	760 - 818			
WG-KOSZ90-10	860 - 918			
WG-KOSZ60-60	560 - 618		antracyt anthracite антрацит	
WG-KOSZ70-60	660 - 718			
WG-KOSZ80-60	760 - 818			
WG-KOSZ90-60	860 - 918			

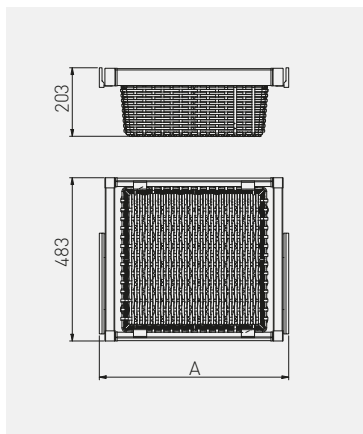

Kosz rattanowy ELITE
 Rattan basket ELITE
 Плетеная из rattana корзина ELITE





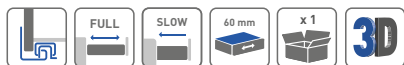

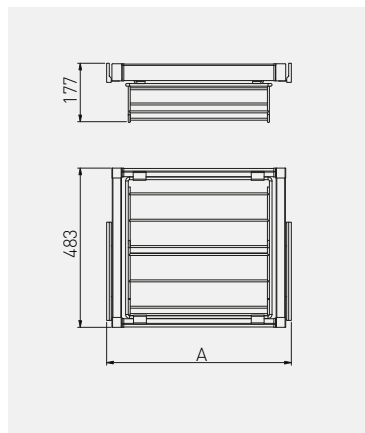

	 A min./max.			
WG-KOSZR60-10	560 - 618	pełny full полное	biały white белый	stal, tworzywo steel, plastic сталь, пластмасса
WG-KOSZR70-10	660 - 718			
WG-KOSZR80-10	760 - 818			
WG-KOSZR90-10	860 - 918			
WG-KOSZR60-60	560 - 618		antracyt anthracite антрацит	
WG-KOSZR70-60	660 - 718			
WG-KOSZR80-60	760 - 818			
WG-KOSZR90-60	860 - 918			



Szuflada ELITE na obuwie
 Pull out shoes rack ELITE
 Полка для обуви ELITE





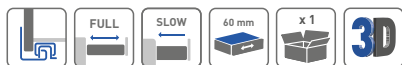

	A min./max.			
WG-POBUW60-10	560 - 618			
WG-POBUW70-10	660 - 718			
WG-POBUW80-10	760 - 818			
WG-POBUW90-10	860 - 918			
WG-POBUW60-60	560 - 618			
WG-POBUW70-60	660 - 718			
WG-POBUW80-60	760 - 818			
WG-POBUW90-60	860 - 918			
			antracyt anthracite антрацит	

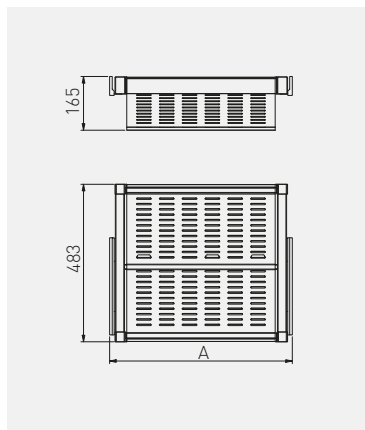

Szuflada ELITE na obuwie metalowa
 Metal pull out shoes rack ELITE
 Металлическая полка для обуви ELITE





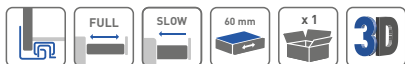

	A min./max.			
WG-POBUWM60-10	560 – 618	pełny full полное	biały white белый	stal, tworzywo steel, plastic сталь, пластмасса
WG-POBUWM70-10	660 – 718			
WG-POBUWM80-10	760 – 818			
WG-POBUWM90-10	860 – 918			
WG-POBUWM60-60	560 – 618		antracyt anthracite антрацит	
WG-POBUWM70-60	660 – 718			
WG-POBUWM80-60	760 – 818			
WG-POBUWM90-60	860 – 918			

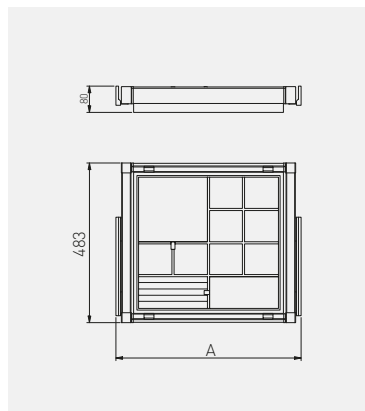

Organizer ELITE
Organiser ELITE
Органайзер ELITE



	A min./max.			
WG-PRZEG60-10	560 - 618	pełny full полное	biały white белый	stal, tworzywo steel, plastic сталь, пластмасса
WG-PRZEG70-10	660 - 718			
WG-PRZEG80-10	760 - 818			
WG-PRZEG90-10	860 - 918			
WG-PRZEG60-60	560 - 618		antracyt anthracite антрацит	
WG-PRZEG70-60	660 - 718			
WG-PRZEG80-60	760 - 818			
WG-PRZEG90-60	860 - 918			

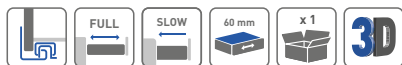

Wieszak ELITE na spodnie
Wardrobe trouser rack ELITE
Вешалка для брюк ELITE

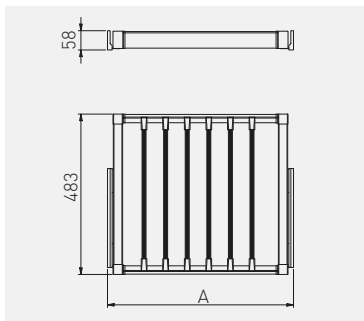

	A min./max.				
WG-WSPOD60-10	560 – 618	petny full полное	biały white белый	stal, tworzywo steel, plastic сталь, пластмасса	
WG-WSPOD70-10	660 – 718				
WG-WSPOD80-10	760 – 818				
WG-WSPOD90-10	860 – 918				
WG-WSPOD60-60	560 – 618				
WG-WSPOD70-60	660 – 718				
WG-WSPOD80-60	760 – 818				
WG-WSPOD90-60	860 – 918				
					antracyt anthracite антрацит

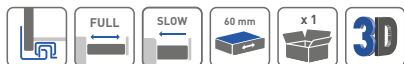

Belka do szuflady ELITE
ELITE wardrobe drawer bar
Балка ящика ELITE

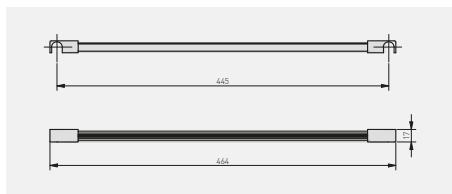

	ilość drutów number of wires Количество проводов	dodatkowa belka additional bar Дополнительная балка	
WG-WSPOD60	6	WG-WSPOD-BAR-10 WG-WSPOD-BAR-60	aluminium, tworzywo aluminium, plastic алюминий, пластмасса
WG-WSPOD70	7		
WG-WSPOD80	8		
WG-WSPOD90	9		

Drażek prostokątny z rozetkami
 Rectangular wardrobe rail with socket
 Прямоугольный мебельный вкладыш

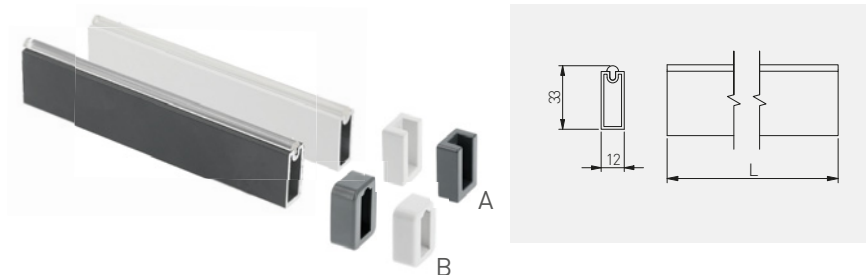

	L mm		
WG-RRPSET-A-10	3000	biały white белый	aluminium, tworzywo aluminium, plastic алюминий, пластмасса
WG-RRPSET-B-10		antracyt anthracite антрацит	
WG-RRPSET-A-60			
WG-RRPSET-B-60			



Rozetka prostokątna
 Rectangular wardrobe rail socket
 Прямоугольный монтажный крепеж

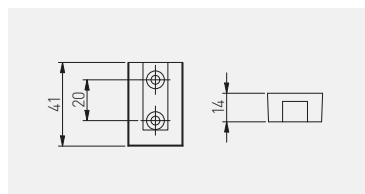

WG-RDRP-10	rozetka prostokątna z zaślepką rectangular wardrobe rail socket with end cap прямоугольный монтажный крепеж с заглушкой	biały white белый	ZnAl, tworzywo ZnAl, plastic ZnAl, пластмасса	
WG-RDRP-60		antracyt anthracite антрацит		
WG-RDRO-10	rozetka prostokątna bez zaślepki rectangular wardrobe rail socket without end cap прямоугольный монтажный крепеж без заглушки	biały white белый	ZnAl	
WG-RDRO-60		antracyt anthracite антрацит		



Pantograf z podnośnikiem olejowym
 Pull-down wardrobe rail – oil
 Пантограф с масляным подъемником

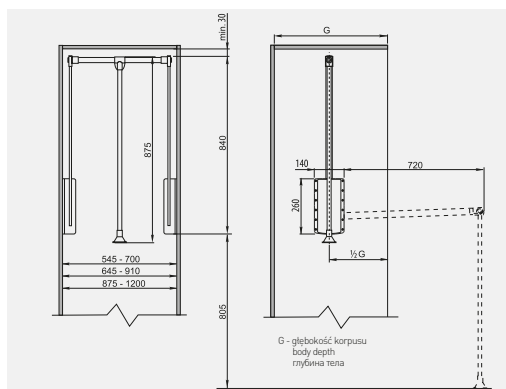

PG-ST83115-10A	875 – 1200	8	biały white белый	stal steel сталь
PG-ST6083-10A	645 – 910			
PG-ST4560-10A	545 – 700			
PG-ST83115-60	875 – 1200		antracyt anthracite антрацит	
PG-ST6083-60	645 – 910			
PG-ST4560-60	545 – 700			





Szuflada SMART na obuwie
Pull out shoes rack SMART
Полка SMART для обуви

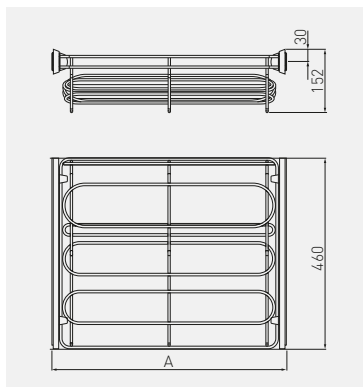

A
min./max.



W-WOBU60-BP-60	komplet bez prowadnic set without slides комплексция без направляющих	600	pełny full полное	560 – 568	szary gray серый	stal, tworzywo steel, plastic сталь, пластмасса
W-WOBU70-BP-60	komplet bez prowadnic set without slides комплексция без направляющих	700		660 – 668		
W-WOBU80-BP-60	komplet bez prowadnic set without slides комплексция без направляющих	800		760 – 768		
W-WOBU90-BP-60	komplet bez prowadnic set without slides комплексция без направляющих	900		860 – 868		







W-W0BU60-BP-10	komplet bez prowadnic set without slides комплексция без направляющих	600		560 - 568		
W-W0BU70-BP-10	komplet bez prowadnic set without slides комплексция без направляющих	700		660 - 668		
W-W0BU80-BP-10	komplet bez prowadnic set without slides комплексция без направляющих	800	pełny full полное	760 - 768	biały white белый	stal, tworzywo steel, plastic сталь, пластмасса
W-W0BU90-BP-10	komplet bez prowadnic set without slides комплексция без направляющих	900		860 - 868		

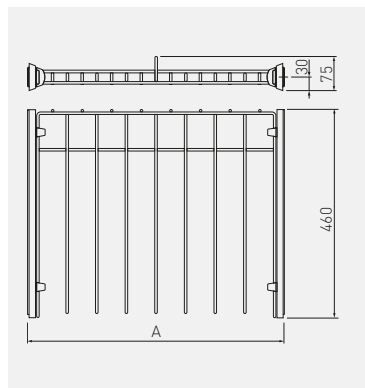

Wieszak SMART na spodnie
 SMART wardrobe trouser rack
 Вешалка SMART для брюк



		 mm	 min./max.	 A	
W-WSPD60-BP-60	komplet bez prowadnic set without slides комплектция без направляющих	600	pełny full полное	560 - 568	szary gray серый stal, tworzywo steel, plastic сталь, пластмасса
W-WSPD70-BP-60	komplet bez prowadnic set without slides комплектция без направляющих	700		660 - 668	
W-WSPD80-BP-60	komplet bez prowadnic set without slides комплектция без направляющих	800		760 - 768	
W-WSPD90-BP-60	komplet bez prowadnic set without slides комплектция без направляющих	900		860 - 868	





A
min./max.



W-WSPD60-BP-10	komplet bez prowadnic set without slides комплексия без направляющих	600		560 – 568		
W-WSPD70-BP-10	komplet bez prowadnic set without slides комплексия без направляющих	700		660 – 668		
W-WSPD80-BP-10	komplet bez prowadnic set without slides комплексия без направляющих	800	pełny full полное	760 – 768	biały white белый	stal, tworzywo steel, plastic сталь, пластмасса
W-WSPD90-BP-10	komplet bez prowadnic set without slides комплексия без направляющих	900		860 – 868		



Kosz SMART na bieliznę
 SMART wardrobe basket
 Корзина для шкафа SMART

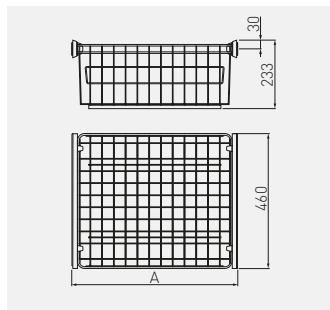

W-WK060-BP-60	komplet bez prowadnic set without slides комплексия без направляющих	600		560 - 568		
W-WK070-BP-60	komplet bez prowadnic set without slides комплексия без направляющих	700		660 - 668		
W-WK080-BP-60	komplet bez prowadnic set without slides комплексия без направляющих	800	pełny full полное	760 - 768	szary gray серый	stal, tworzywo steel, plastic сталь, пластмасса
W-WK090-BP-60	komplet bez prowadnic set without slides комплексия без направляющих	900		860 - 868		





A
min./max.



		mm		A min./max.		
W-WK060-BP-10	komplet bez prowadnic set without slides комплексция без направляющих	600		560 – 568		
W-WK070-BP-10	komplet bez prowadnic set without slides комплексция без направляющих	700		660 – 668		
W-WK080-BP-10	komplet bez prowadnic set without slides комплексция без направляющих	800	pełny full полное	760 – 768	biały white белый	stal, tworzywo steel, plastic сталь, пластмасса
W-WK090-BP-10	komplet bez prowadnic set without slides комплексция без направляющих	900		860 – 868		



Wieszak SMART na paski i krawaty
 SMART belt and tie rack
 Вешалка для ремней и галстуков SMART

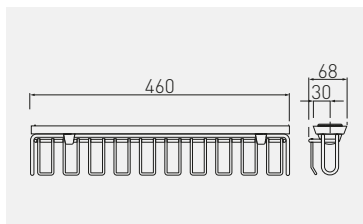
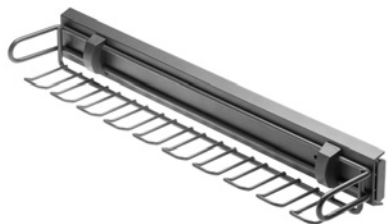







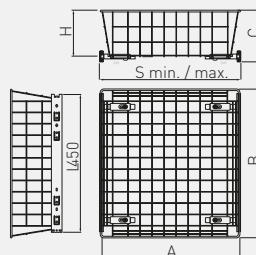

W-WKRP-BP-60	komplet bez prowadnic set without slides комплексция без направляющих			
W-WKRP-VE-60	na prowadnicy kulkowej H45 z funkcją cichego zamknięcia on ball bearing slide H45 with soft closing на шариковой направляющей H45 с доводчиком		szary gray серый	
W-WKRP-BP-10	komplet bez prowadnic set without slides комплексция без направляющих	pełny full полное		stal, tworzywo steel, plastic сталь, пластмасса
W-WKRP-VE-10	na prowadnicy kulkowej H45 z funkcją cichego zamknięcia on ball bearing slide H45 with soft closing на шариковой направляющей H45 с доводчиком		biały white белый	



Kosz do szaf
 Wardrobe basket
 Корзина для шкафа



		 H mm	 A mm	 B mm	 C mm	 S min/max			
KO-SR100-30-10		300	255	485	123	260-285	осынок galvanizacja гальваніка	biały white белый	stal tworzywo steel plastic сталь пластмасса
KO-SR100-40-10		400	355	485	123	360-385			
KO-SR100-50-10t		500	455	485	123	460-485			
KO-SR100-60-10		600	555	485	123	560-585			
KO-SR150-30-10		300	255	485	173	260-285			
KO-SR150-40-10		400	355	485	173	360-385			
KO-SR150-50-10		500	455	485	173	460-485			
KO-SR150-60-10		600	555	485	173	560-585			
KO-SR200-30-10		300	255	485	223	260-285			
KO-SR200-40-10		400	355	485	223	360-385			
KO-SR200-50-10		500	455	485	223	460-485			
KO-SR200-60-10		600	555	485	223	560-585			
KO-SR100-30-0C		300	255	485	123	260-285			
KO-SR100-40-0C		400	355	485	123	360-385			
KO-SR100-50-0C		500	455	485	123	460-485			
KO-SR100-60-0C		600	555	485	173	260-285			
KO-SR150-30-0C		300	255	485	123	260-285			
KO-SR150-40-0C		400	355	485	173	360-385			
KO-SR150-50-0C		500	455	485	173	460-485			
KO-SR150-60-0C		600	555	485	173	560-585			
KO-SR200-30-0C		300	255	485	223	260-285			
KO-SR200-40-0C		400	355	485	223	360-385			
KO-SR200-50-0C		500	455	485	223	460-485			
KO-SR200-60-0C		600	555	485	223	560-585			
								srebrny silver серебристый	



Produkt do montażu na prowadnicach H35, H45 oraz rolkowych - komplet bez prowadnic.
 Product mounted on H35, H45 and roller slides - set without slides
 Продукт для установки на направляющих H35, H45 и роликовых направляющих. Комплект без направляющих.

Wieszak na spodnie podwieszany
Wardrobe pull-out trouser rack
Вешалка для брюк подвесная

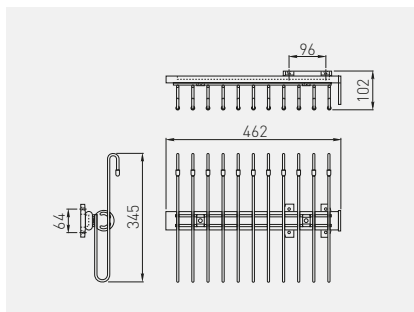

WW-WSP00-01	niepety partial неполное	chrom, aluminium, czarny chrome, aluminium, black хром, алюминий, чёрный	stal, aluminium, tworzywo steel, aluminium, plastic сталь, алюминий, пластмасса

Wieszak WS na spodnie
Trouser rack WS
Вешалка WS для брюк

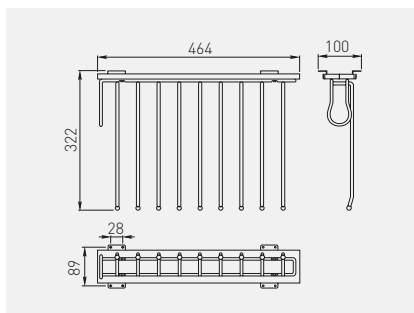

WW-WSP00-01	prawy right правый	niecety partial неполное	chrom, aluminium, czarny chrome, aluminium, black хром, алюминий, чёрный	stal, aluminium, tworzywo steel, aluminium, plastic сталь, алюминий, пластмасса
WW-WSL00-01	lewy left левый			

Wieszak WU na ubrania
Clothes hanger WU
Вешалка WU для одежды

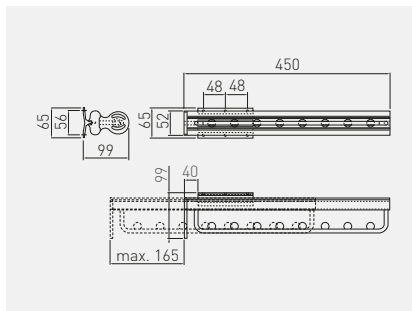

WW-WUBR00-01	niepełny partial неполное	chrom, aluminium, czarny chrome, aluminium, black хром, алюминий, чёрный	stal, aluminium, tworzywo steel, aluminium, plastic сталь, алюминий, пластмасса





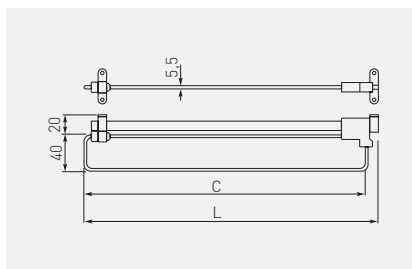



Wieszak WSL
Hanger WSL
Вешалка WSL

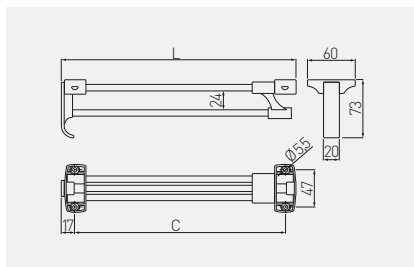

	C mm	L mm		
WW-WSL250-01	235	250	chrom chrome хром	stal steel сталь
WW-WSL300-01	285	300		
WW-WSL350-01	335	350		
WW-WSL400-01	385	400		
WW-WSL450-01	435	450		
WW-WSL500-01	485	500		





Wieszak WSD wysuwny
Retractable hanger WSD
Выдвижная подвеска WSD

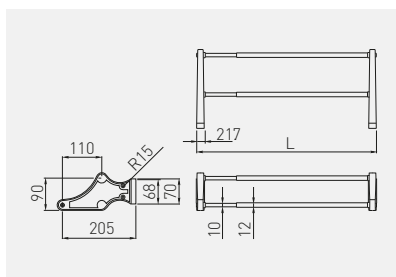

	 C mm	 L mm		
WW-WSD250-01B	220	252	chrom, czarny chrome, black хром, чёрный	stal, tworzywo steel, plastic сталь, пластмасса
WW-WSD300-01B	270	302		
WW-WSD350-01B	320	352		
WW-WSD400-01B	370	402		
WW-WSD450-01B	420	452		
WW-WSD500-01B	470	502		

Półka na obuwie
Shoe rack
Полка для обуви



	 L mm		
PP-P04570-20	415 - 700	chrom, aluminium, czarny chrome, aluminium, black хром, алюминий, чёрный	stal, aluminium, tworzywo steel, aluminium, plastic сталь, алюминий, пластмасса
PP-P80110-20	715 - 1100	chrom, czarny chrome, black хром, чёрный	stal, tworzywo steel, plastic сталь, пластмасса



Zawias do półki na obuwie
Hinge for shoe rack
Крепление для полки под обувь

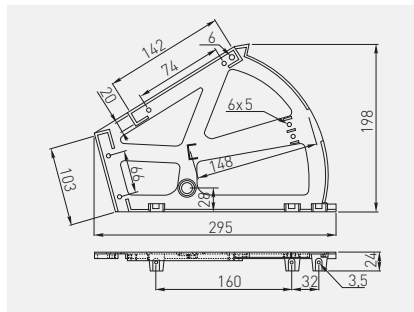

Zastosowanie dla płyty 12 mm
For 12 mm board
Крепление к плите 12 мм



WW-ZWBUT2-10	biały / white / белый	tworzywo plastic пластмасса
WW-ZWBUT2-20	czarny / black / чёрный	



Pantograf z podnośnikiem gazowym
Pull-down wardrobe rail – gas
Пантограф с газовым подъемником

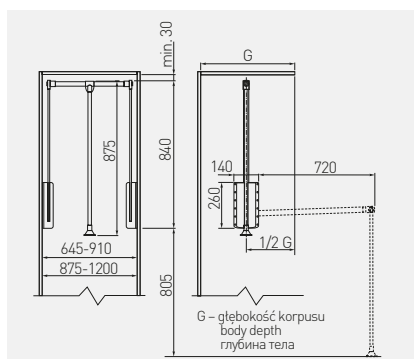





PG-GA4560-10	545 – 700	12	biały / white / белый	stal, tworzywo steel, plastic сталь, пластмасса
PG-GA6083-10	645 – 910			
PG-GA83115-10	875 – 1200		czarny / black / чёрный	
PG-GA4560-20	545 – 700			
PG-GA6083-20	645 – 910			
PG-GA8311520	875 – 1200			

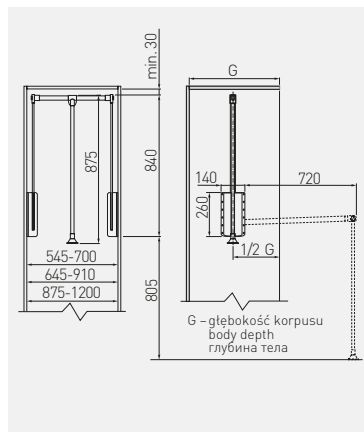

Pantograf z podnośnikiem olejowym
 Pull-down wardrobe rail – oil
 Пантограф с масляным подъемником



	 mm	 kg		
PG-AL4560-20	545 - 700	8	aluminium / aluminium / алюминий	aluminium, tworzywo aluminium, plastic алюминий, пластмасса
PG-AL6083-20	645 - 910			
PG-AL8311520	875 - 1200			
PG-ST4560-10	545 - 700		biały / white / белый	stal, tworzywo steel, plastic сталь, пластмасса
PG-ST4560-20	645 - 910		czarny / black / чёрный	
PG-ST6083-10			biały / white / белый	
PG-ST6083-20	czarny / black / чёрный			
PG-ST83115-10	875 - 1200		biały / white / белый	
PG-ST8311520		czarny / black / чёрный		





Segregator PRACTI ECO 400
 Trash bin PRACTI ECO 400
 Сегрегатор PRACTI ECO 400

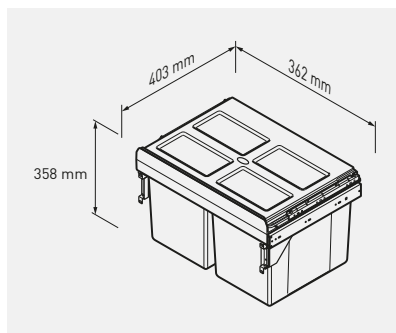

PB-45-400MF-2X16-60A

400

2 x 16 L

antracyt
 anthracite
 антрацит

tworzywo / plastic / пластмасса



Segregator PRACTI ECO 300
 Trash bin PRACTI ECO 300
 Сегрегатор PRACTI ECO 300



PB-45-0010X3-60A



PB-45-002010-60A

Na prowadnicy kulkowej H45 z cichym domykaniem
 On ball bearing slide H45 with soft closing
 На шариковой направляющей H45 с доводчиком

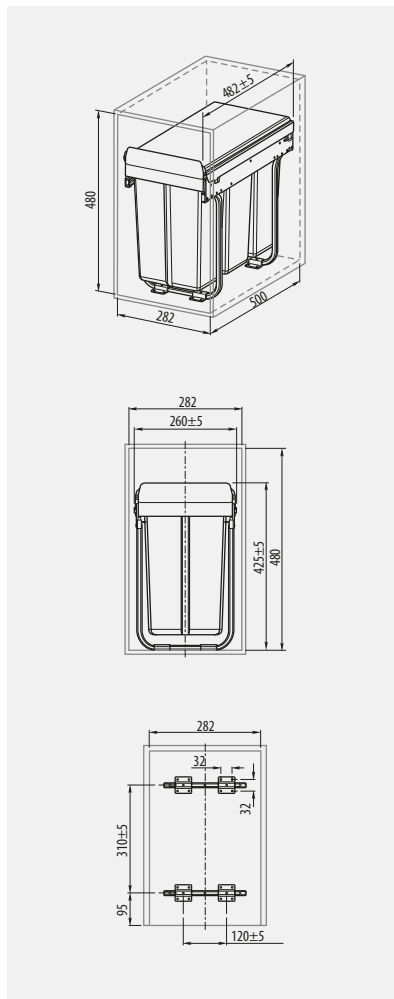

		 mm			
PB-45-0010X3-60A		300	3 x 10 L	antracyt anthracite антрацит	tworzywo / plastic / пластмасса
PB-45-002010-60A		300	10 L, 20 L		



Segregator PRACTI ECO 400
 Trash bin PRACTI ECO 400
 Сегрегатор PRACTI ECO 400









PB-45-002X20-60A

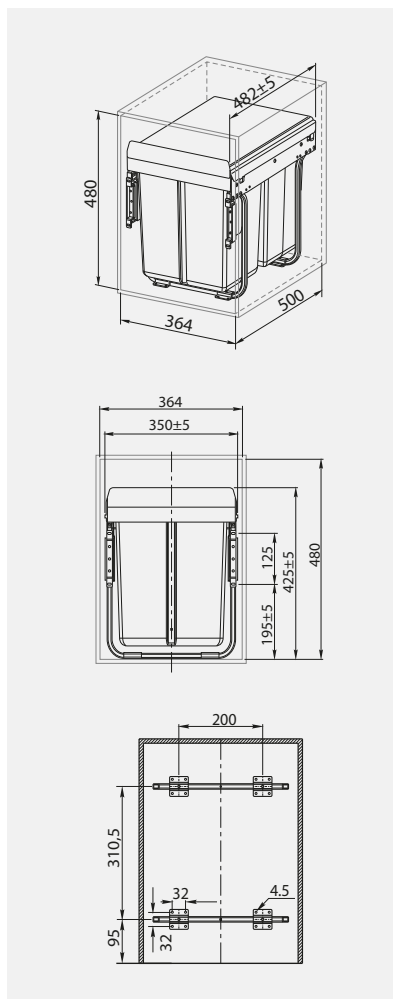

PB-45-202X10-60A

Na prowadnicy kulkowej H45 z cichym domykiem
 On ball bearing slide H45 with soft closing
 На шариковой направляющей H45 с доводчиком



		 mm			
PB-45-002X20-60A	400	2 x 20 L	antracyt anthracite антрацит	tworzywo / plastic / пластмасса	
PB-45-202X10-60A	400	20 L, 2 x 10 L			



Segregator PRACTI ECO 400 z mocowaniem przednim
 Trash bin PRACTI ECO 400 with door mount bracket
 Сегрегатор PRACTI ECO 400 с передним креплением









PB-45-MF002X20-60A

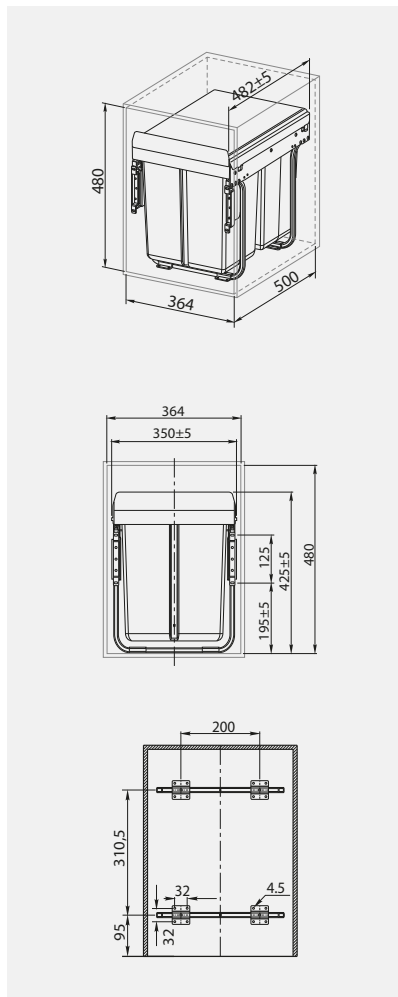

PB-45-MF202X10-60A

Na prowadnicy kulkowej H45 z cichym domykiem
 On ball bearing slide H45 with soft closing
 На шариковой направляющей H45 с доводчиком



					
PB-45-MF002X20-60A		400	2 x 20 L	antracyt anthracite антрацит	tworzywo / plastic / пластмасса
PB-45-MF202X10-60A			20 L, 2 x 10 L		



Segregator PRACTI ECO 450, niski
 Trash bin PRACTI ECO 450, low
 Сегрегатор PRACTI ECO 450, низкий



PB-45-002X15-60A

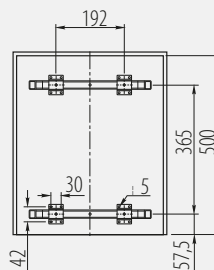
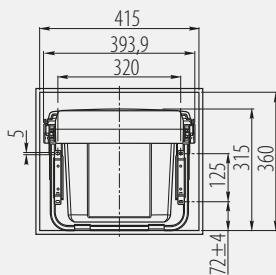
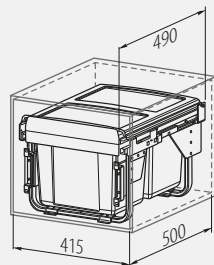

Na prowadnicy z cichym domykiem
 On slide with soft closing
 На направляющей с доводчиком



PB-45-002X15-60A	450	2 x 15 L	antracyt anthracite антрацит	tworzywo / plastic / пластмасса
------------------	-----	----------	------------------------------------	---------------------------------



Segregator PRACTI ECO 450 niski z mocowaniem przednim
 Trash bin PRACTI ECO 450 low with door mount bracket
 Сегрегатор PRACTI ECO 450 низкий с передним креплением



PB-45-MF2X15-60A

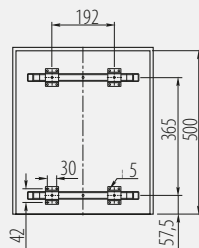
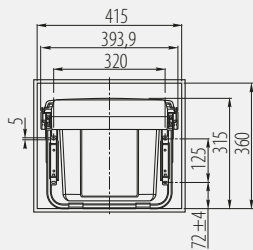
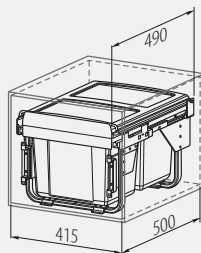

Na prowadnicy z cichym domykiem
 On slide with soft closing
 На направляющей с доводчиком



PB-45-MF2X15-60A	450	2 x 15 L	antracyt anthracite антрацит	tworzywo / plastic / пластмасса
------------------	-----	----------	------------------------------------	---------------------------------



Segregator PRACTI ECO 450 wysoki
 Trash bin PRACTI ECO 450 high
 Сегрегатор PRACTI ECO 450 высокий







PB-45-450-2X20-60A

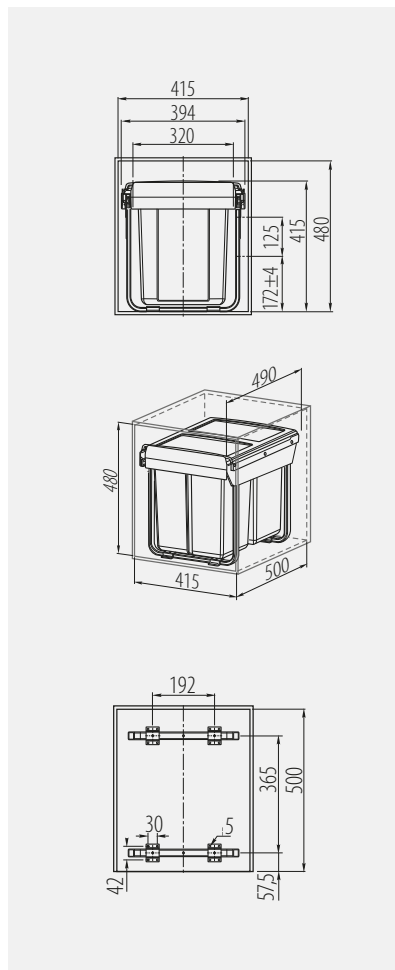

PB-45-0202X10-60A



Na prowadnicy z cichym domykiem
 On slide with soft closing
 На направляющей с доводчиком

		 mm			
PB-45-450-2X20-60A		450	2 x 20 L	antracyt anthracite антрацит	tworzywo / plastic / пластмасса
PB-45-0202X10-60A			20 L, 2 x 10 L		



Segregator PRACTI ECO 450 wysoki z mocowaniem przednim
 Trash bin PRACTI ECO 450 high with door mount bracket
 Сегрегатор PRACTI ECO 450 высокий с передним креплением







PB-45-450MF202X10-60A

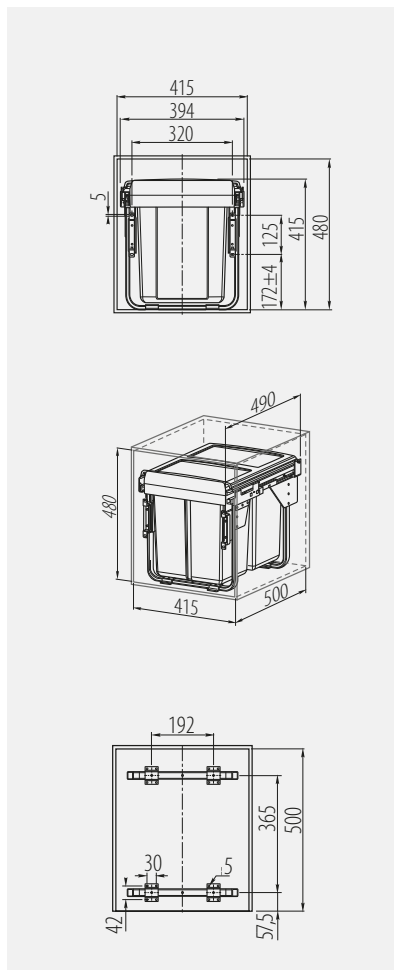

PB-45-MF2X20-60A



Na prowadnicy z cichym domykiem
 On slide with soft closing
 На направляющей с доводчиком

				
PB-45-450MF202X10-60A	450	20 L, 2 x 10 L	antracyt anthracite антрацит	tworzywo / plastic / пластмасса
PB-45-MF2X20-60A		2 x 20 L		



Segregator PRACTI ECO 600 wysoki z mocowaniem przednim
 Trash bin PRACTI ECO 600 high with door mount bracket
 Сегрегатор PRACTI ECO 600 высокий с передним креплением







PB-45-MF342X17-60A

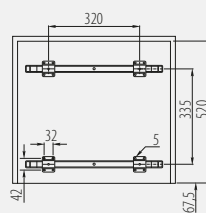
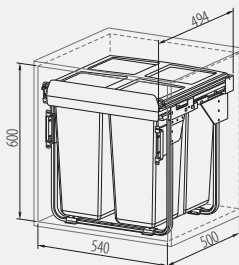
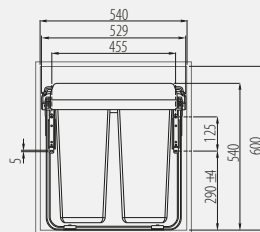

PB-45-MF2X34-60A



Na prowadnicy z cichym domykiem
 On slide with soft closing
 На направляющей с доводчиком

	 mm			
PB-45-MF342X17-60A	600	34 L, 2 x 17 L	antracyt anthracite антрацит	tworzywo / plastic / пластмасса
PB-45-MF2X34-60A		2 x 34 L		



Segregator PRACTI ECO 600
 Trash bin PRACTI ECO 600
 Сегрегатор PRACTI ECO 600

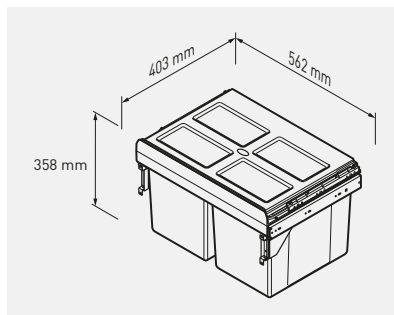



				
PB-45-600MF-2X27-60A	600	2 x 27 L	antracyt anthracite антрацит	tworzywo / plastic / пластмасса

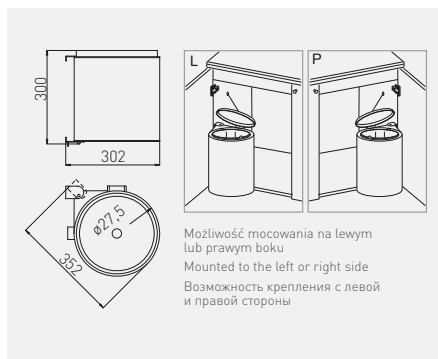

Kosz CIRCA
 Trash bin CIRCA
 Мусорная корзина CIRCA



			
PB-91024160V	11 L	szary / gray / серый	tworzywo / plastic / пластмасса



Segregator MULTINO Trash bin MULTINO Сегрегатор MULTINO

Przeznaczony do szuflad Modern Box / Axis Pro
For Modern Box / Axis Pro drawers
Только для ящиков Modern Box / Axis Pro



PB-93004162601



PB-91114100B5-A



PB-91104100B5-A

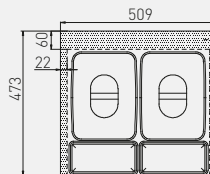
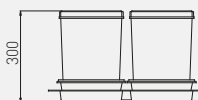
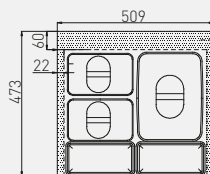
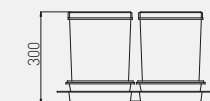
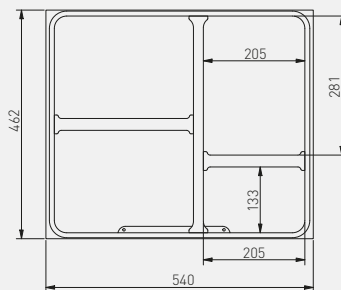

PB-93004162601	540	3 x 15 L, 1 x 7 L	antracyt anthracite антрацит	tworzywo plastic пластмасса
PB-91104100B5-A	600	2 x 15 L, 2 brytfanki / 2 tray storage spaces / наполнители		
PB-91114100B5-A		1 x 15 L, 2 x 7 L, 2 brytfanki / 2 tray storage spaces / наполнители		
PB-91644100B5V-A	800	3 x 15 L, 3 brytfanki / 3 tray storage spaces / наполнители		
PB-91634100B5V-A		2 x 15L, 2 x 7 L, 3 brytfanki / 3 tray storage spaces / наполнители		
PB-91164100B5-A		3 x 15 L, 3 brytfanki / 3 tray storage spaces / наполнители		





PB-91634100B5V-A



PB-91644100B5



PB-91174100B5-A



PB-91164100B5-A

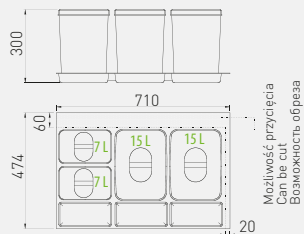
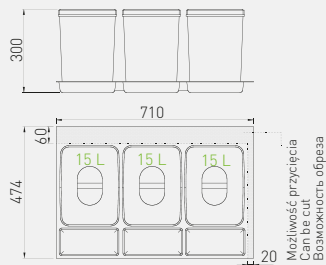

Segregator MULTINO 800 (bez przycinania) jest dopasowany do szuflady MODERN BOX NL = 500 zamontowanej w korpusie LW = 764*

Without modifications, the MULTINO 800 trash bin is designed to fit MODERN BOX NL = 500 drawer, mounted in a cabinet LW = 764*

Segregator MULTINO 800 (без обреза) подходит к системе ящиков MODERN BOX NL = 500, замонтированной в корпусе LW = 746*

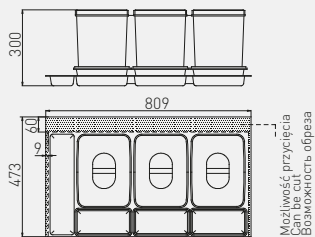
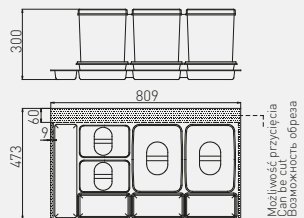

Corner MovixPro 450
 Corner MovixPro 450
 Корзина MovixPro 450

NEW

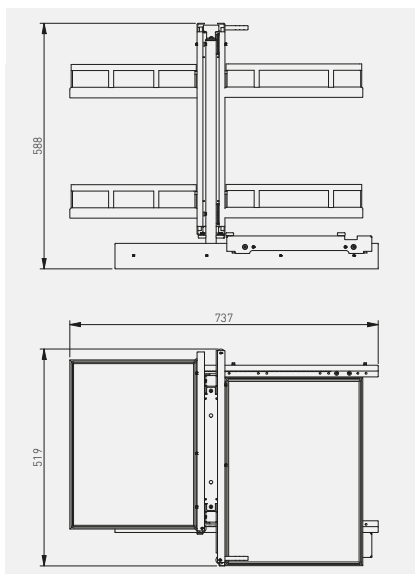

KO-WMC450-60	antracyt anthracite антрацит	stal steel сталь
KO-WMC450-01	chrome chrome хром	



Corner MovixPro 450
 Corner MovixPro 450
 Корзина MovixPro 450

NEW

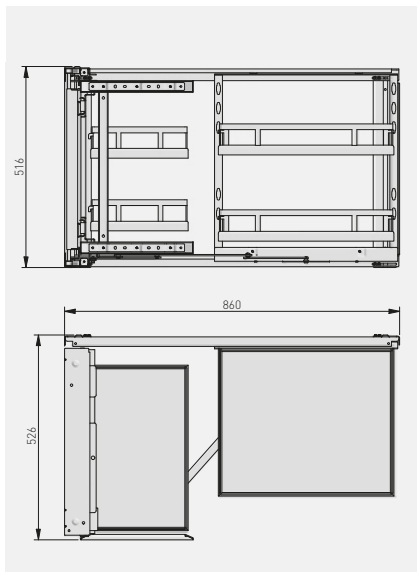

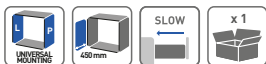

KO-UMC450-60	antracyt anthracite антрацит	stal steel сталь
KO-UMC450-01	chrome chrome хром	stal steel сталь

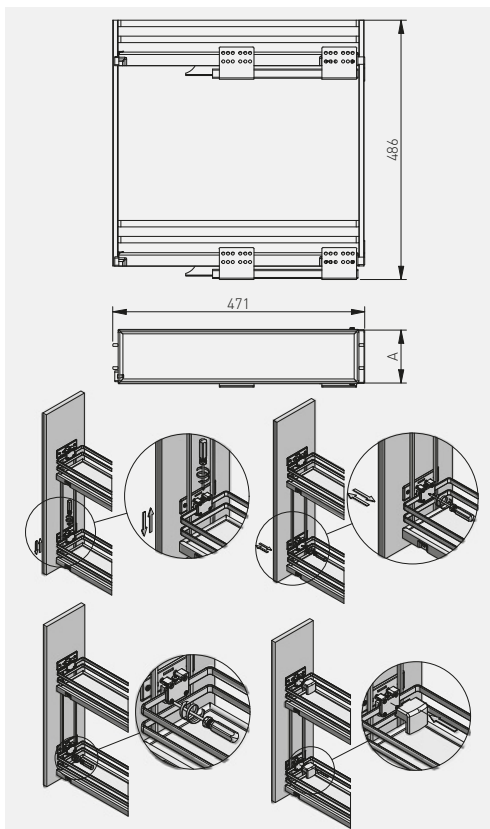

Cargo boczne MOVIX PRO
Side cargo MOVIX PRO
Боковое карго MOVIX PRO

NEW



	 mm			
KO-150BO-60	150	оцинк galvanized гальваніка	антрацит anthracite антрацит	stal steel сталь
KO-200BO-60	200			
KO-150BO-01	150		chrom chrome хром	
KO-200BO-01	200			



* Produkt nie zawiera prowadnic.
 Produkty komplementarne: dla rozmiarów szafek 150, 200 mm – prowadnice z cichym domykiem PB-KO450BO-L2 i PB-KO450BO-R2 oraz dla rozmiaru szafek 300, 400, 500 mm – prowadnice z cichym domykiem PB-KO450BO-U.
 * Product does not include slides.
 Complementary products: for cabinet sizes 150, 200 mm - PB-KO450BO-L2 and PB-KO450BO-R2 slides with soft close, whereas for cabinet sizes 300, 400, 500 mm - PB-KO450BO-U slides with soft close.
 * В состав продукта не входят направляющие
 Дополнительные продукты: для шкафов размером 150, 200 мм - направляющие с доводчиком PB-KO450BO-L2 и PB-KO450BO-R2 и для шкафа размером 300, 400, 500 мм - направляющие с доводчиком PB-KO450BO-U.



Cargo boczne MOVIX PRO
 Side cargo MOVIX PRO
 Боковое карго MOVIX PRO

NEW

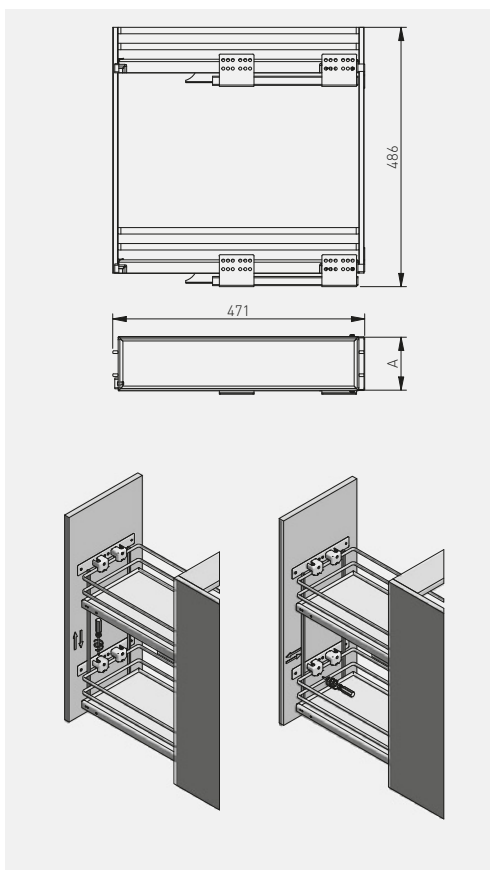

KO-300BO-60	300	ocynk galvanized гальваніка	antracyt anthracite антраціт	stal steel сталь
KO-400BO-60	400			
KO-500BO-60	500		chrom chrome хром	
KO-300BO-01	300			
KO-400BO-01	400			
KO-500BO-01	500			



* Produkt nie zawiera prowadnic.

Produkty komplementarne: dla rozmiarów szafek 150, 200 mm – prowadnice z cichym domykaniem PB-KO450BO-L2 i PB-KO450BO-R2 oraz dla rozmiaru szafek 300, 400, 500 mm – prowadnice z cichym domykaniem PB-KO450BO-U.

* Product does not include slides.

Complementary products: for cabinet sizes 150, 200 mm - PB-KO450BO-L2 and PB-KO450BO-R2 slides with soft close, whereas for cabinet sizes 300, 400, 500 mm - PB-KO450BO-U slides with soft close.

* В состав продукта не входят направляющие

Дополнительные продукты: для шкафов размером 150, 200 мм - направляющие с доводчиком PB-KO450BO-L2 и PB-KO450BO-R2 и для шкафа размером 300, 400, 500 мм - направляющие с доводчиком PB-KO450BO-U.





Cargo boczne na prowadnicach dolnego montażu

Side cargo on bottom mount slides

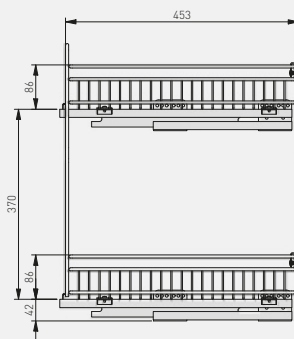
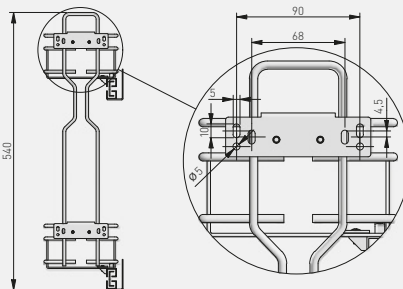
Боковая корзина карго на направляющих нижнего монтажа

NEW



	 mm		
KO-150BO-E-01	150	chrom chrome хром	stal steel сталь
KO-200BO-E-01	200		



* Produkt nie zawiera prowadnic.

Produkty komplementarne - prowadnice soft close PB-K0450BO-E-L PB-K0450BO-E-R.

* Product does not include slides.





Complementary products - slides with soft close PB-K0450BO-E-L PB-K0450BO-E-R.

* Продукт не включает направляющие.

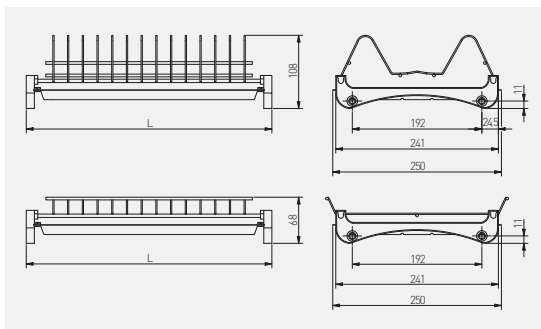
Дополнительные продукты - направляющие с доводчиком PB-K0450BO-E-L и PB-K0450BO-E-R.

Ociekarka dwupoziomowa do montażu
 Two tier dish drying rack
 Двухуровневая сушилка для посуды (встраиваемая)



		 L mm		
OC-2PV340-02-18	do płyty 18 mm for 18 mm board для поверхности 18 мм	400	chrom chrome хром	stal nierdzewna, tworzywo stainless steel, plastic нержавеющая сталь, пластмасса
OC-2PV345-02-18		450		
OC-2PV350-02-18		500		
OC-2PV360-02-18		600		
OC-2PV360-02-18A*		600		
OC-2PV370-02-18		700		
OC-2PV380-02-18		800		
OC-2PV380-02-18A*		800		
OC-2PV390-02-18		900		



Ociekarka dwupoziomowa A04, wolnostojąca
 Two tier dish drying rack A04
 Сушилка для посуды настольная A04, двухуровневая

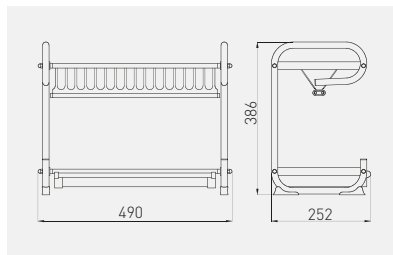

OC-A0450-06



stal szczotkowana
 brushed steel
 шлифованная сталь



stal nierdzewna
 stainless steel
 нержавеющая сталь



Ociekarka dwupoziomowa A03, wolnostojąca
 Two tier dish drying rack A03
 Сушилка для посуды настольная A03, двухуровневая

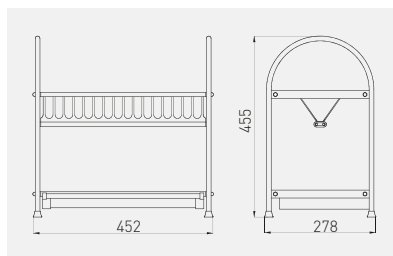

OC-A0350K-06



stal szczotkowana
 brushed steel
 шлифованная сталь



stal nierdzewna
 stainless steel
 нержавеющая сталь



Ociekarka dwupoziomowa z organizerem, wolnostojąca
 Two tier dish drying rack with organizer
 Сушилка для посуды и столовых приборов настольная, двухуровневая

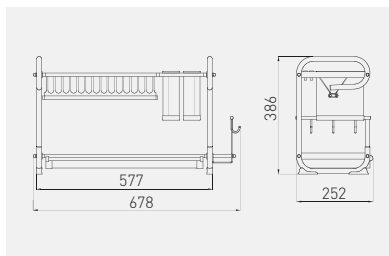

OC-A0460D-06



stal szcztokowana
 brushed steel
 шлифованная сталь



stal nierdzewna
 stainless steel
 нержавеющая сталь



Ociekarka zwijana
 Roll-up drying rack
 Складная сушилка

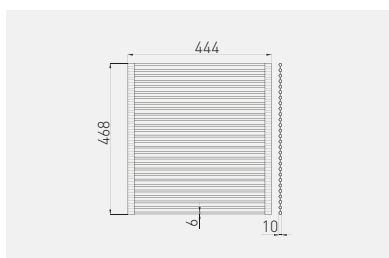
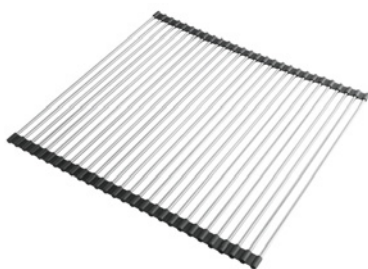

OC-E0707D-CZ



stal szcztokowana, czarny
 brushed steel, black
 шлифованная сталь, чёрный



stal nierdzewna
 stainless steel
 нержавеющая сталь



Półka pod klawiaturę z prowadnicą kulkową 27 mm
 Keyboard shelf with 27 mm drawer slide
 Полка для клавиатуры с шариковой направляющей 27 мм

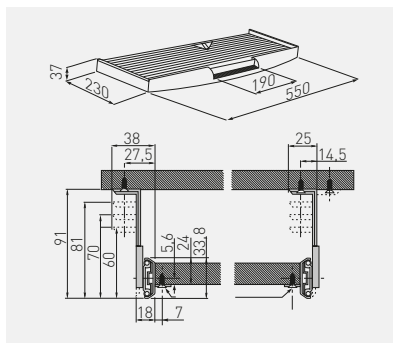

PU-KEY027-20	czarny / black / чёрны	tworzywo plastic пластмасса
PU-KEY027-60	szary / gray / серый	



Półka pod klawiaturę z podkładką na myszkę
 Keyboard shelf with mouse pad
 Полка для клавиатуры с подставкой для мыши

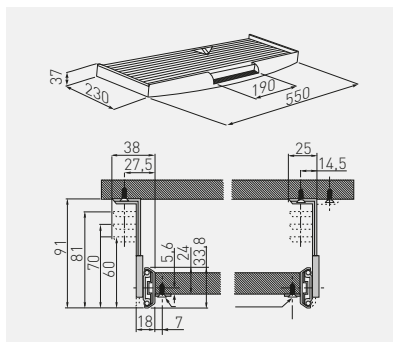

PU-KEYM27-20	czarny / black / чёрны	tworzywo plastic пластмасса
PU-KEYM27-60	szary / gray / серый	



Wózek pod komputer
Computer trolley
Передвижная подставка под компьютер

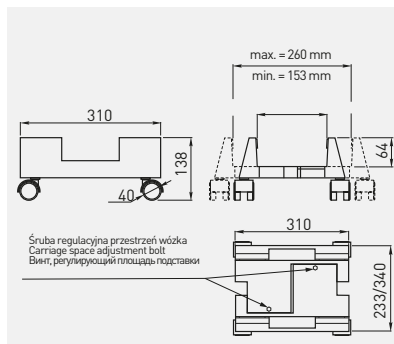
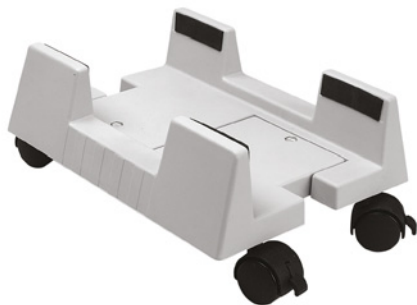

PU-PKO-00-20	czarny / black / чёрны	tworzywo plastic пластмасса
PU-PKO-00-60	szary / gray / серый	



Hub – 4 porty USB
Hub – 4 USB ports
Удлинитель на 4 входа USB

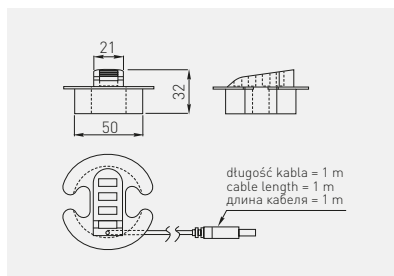

HB-USB-4X-60	srebrny / silver / серебряный	tworzywo plastic пластмасса
--------------	-------------------------------	-----------------------------------



Przepust MERIDA 80
 Desk cable outlet MERIDA 80
 Пропуск для кабеля MERIDA 80

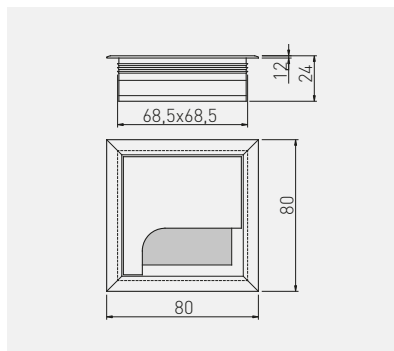





	 mm		
LB-K80X80-05	80 x 80	aluminium / aluminium / алюминий	
LB-K80X80-20		czarny / black / чёрный	
		aluminium aluminium алюминий	

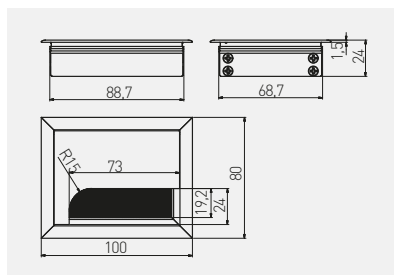

Przepust MERIDA 100
 Desk cable outlet MERIDA 100
 Пропуск для кабеля MERIDA 100



	 mm		
LB-80X100-05	80 x 100	aluminium / aluminium / алюминий	
LB-80X100-20		czarny / black / чёрный	
		aluminium aluminium алюминий	



Przepust MERIDA 160
 Desk cable outlet MERIDA 160
 Пропуск для кабеля MERIDA 160

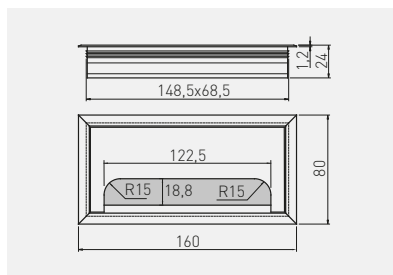

LB-80X160-05	80 x 160	aluminium / aluminium / алюминий	aluminium
LB-80X160-20		czarny / black / чёрный	aluminium aluminium алюминий



Przepust MERIDA 280
 Desk cable outlet MERIDA 280
 Пропуск для кабеля MERIDA 280

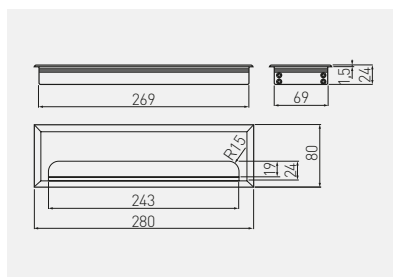

LB-80X280-05	80 x 280	aluminium / aluminium / алюминий	aluminium
LB-80X280-20		czarny / black / чёрный	aluminium aluminium алюминий



Przepust MERIDA 500
 Desk cable outlet MERIDA 500
 Пропуск для кабеля MERIDA 500

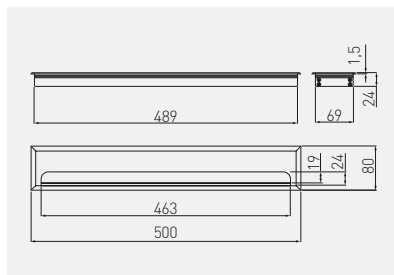

LB-80X500-05	80 x 500	aluminium / aluminium / алюминий	aluminium aluminium алюминий
LB-80X500-20		czarny / black / чёрный	



Przepust LBF
 Desk cable grommet LBF
 Пропуск для кабеля LBF

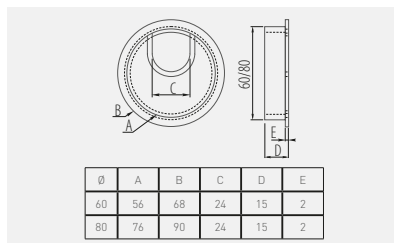

PM-LBFI60-01	60	chrom / chrome / хром	ZnAl
PM-LBFI60-02		satyna / satin / сатин	
PM-LBFI60-05		aluminium / aluminium / алюминий	
PM-LBFI60-06		stal szorstkowana / brushed steel / шлифованная сталь	
PM-LBFI60-20M	czarny mat / black matt / чёрный матовый		
PM-LBFI80-01	80	chrom / chrome / хром	
PM-LBFI80-02		satyna / satin / сатин	
PM-LBFI80-05		aluminium / aluminium / алюминий	
PM-LBFI80-06		stal szorstkowana / brushed steel / шлифованная сталь	
PM-LBFI80-20M		czarny mat / black matt / чёрный матовый	



Przepust PLF
Desk cable grommet PLF
Пропуск для кабеля PLF

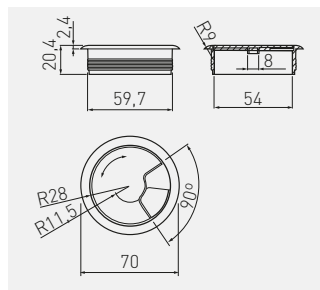

PM-PLFI60-05	aluminium / aluminium / алюминий	tworzywo plastic пластмасса
PM-PLFI60-10	biały / white / белый	
PM-PLFI60-20	czarny / black / чёрный	
PM-PLFI60-30	szary / gray / серый	
PM-PLFI60-43	jasny brąz / light brown / светло-коричневый	
PM-PLFI60-45	orzech / walnut / цвет орех	
PM-PLFI60-47	buk / beech / бук	
PM-PLFI60-49	klon / maple / клен	
PM-PLFI60-50	beż / beige / бежевый	
PM-PLFI60-51	kalwados / calvados / кальвадос	



Zamek K-138
 Lock K-138
 Замок K-138

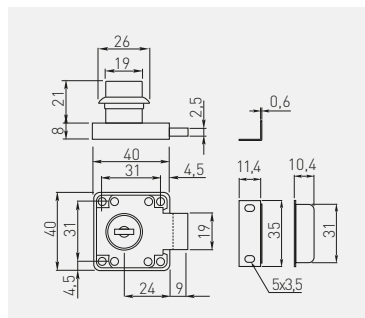

ZZ-KM-138-01-S



chrom / chrome / хром



ZnAl, stal / ZnAl, steel / ZnAl, сталь

Zamek Z-138 z kluczem łamanym
 Lock Z-138 with folding key
 Замок Z-138 со складным ключом

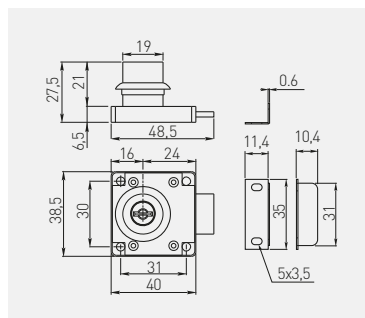

ZZ-ZN-138-01



chrom / chrome / хром



ZnAl, stal / ZnAl, steel / ZnAl, сталь

Zamek C-138 z kluczem cyfrowym
 Lock C-138 with key
 Замок C-138 с цифровым ключом

Kompatybilny z kluczem MASTER
 Compatible with MASTER key
 Подходит для ключа MASTER

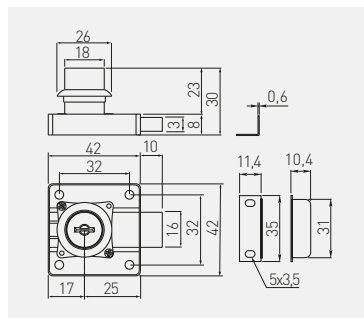

ZZ-CF-138-01



chrom / chrome / хром



ZnAl, stal / ZnAl, steel / ZnAl, сталь

Klucz MASTER do zamka C-138
 MASTER key for C-138 lock
 Ключ MASTER к замку C-138



ZZ-KLMASTER





chrom / chrome / хром

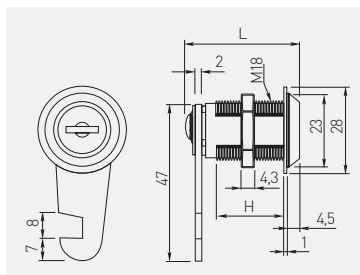

ZnAl, stal / ZnAl, steel / ZnAl, сталь

Zamek Z-103 skrzynkowy
Box lock Z-103
Замок Z-103



	 L mm	 H mm		
ZZ-16-103-01-S	27	12	chrom / chrome / хром	ZnAl, stal / ZnAl, steel / ZnAl, сталь
ZZ-20-103-01-S	30	16,5		
ZZ-30-103-01-S	40	26,5		

Zamek S-409 do szyby
Glass door lock S-409
Замок S-409 для стеклянных дверей

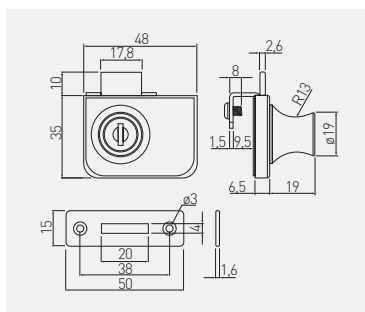

Zastosowanie do szkła 4 – 8 mm
For 4 – 8 mm glass
Толщина стекла 4 – 8 мм

		
ZZ-SZ-409-01-S	chrom / chrome / хром	ZnAl, stal / ZnAl, steel / ZnAl, сталь

Zamek M-201
Lock M-201
Замок M-201

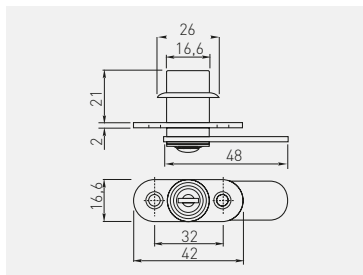

ZZ-M0-201-01-S



chrom / chrome / хром



ZnAl, stal, plastik / ZnAl, steel, plastic / ZnAl, сталь, пластмасса

Zamek Z-202 żaluzjowy
Double hook lock Z-202
Замок Z-202 жалюзийный

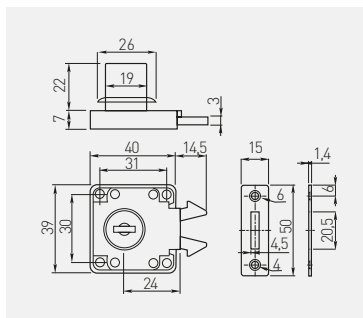

ZZ-Z0-202-01-S



chrom / chrome / хром



ZnAl, stal, plastik / ZnAl, steel, plastic / ZnAl, сталь, пластмасса

Zamek G-328 grzbietowy
Sliding glass door lock G-328
Замок G-328 внутрений

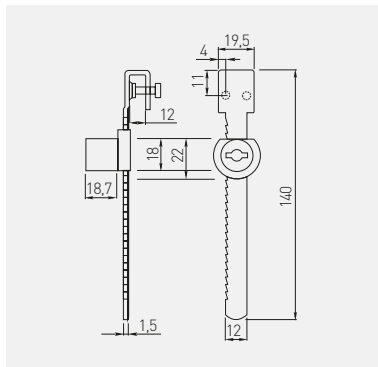

Zastosowanie do szkła 4 – 8 mm
For 4 – 8 mm glass
Толщина стекла 4 – 8 мм



ZZ-G0-328-01



chrom / chrome / хром



ZnAl, stal / ZnAl, steel / ZnAl, сталь

Zamek baskwilowy
Espagnolette lock
Замок шпингалетный

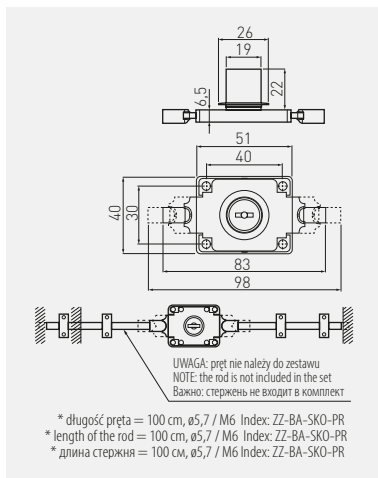

ZZ-BA-SK0-01-S

chrom / chrome / хром



ZZ-BA-SK0-PR

osynk / galvanized / гальваника



stal / steel / сталь

Zamek C-288 centralny
 Cabinet drawer lock C-288
 Замок C-288 центральный боковой

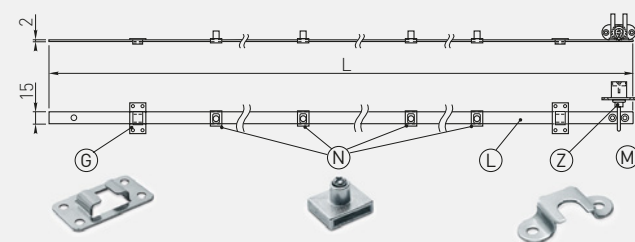

Skład zestawu / Set includes / Состав набора:

- Ⓒ Mocowanie listwy / Slat fixing / Крепление планки
- Ⓓ Blokady szuflady / Drawer locking mechanism / Блокада ящика
- Ⓕ Listwa zamka / Lock slat / Планка замка
- Ⓖ Zamek / Lock / Замок
- Ⓜ Zaczep / Hook / Зацепка

Model	C5	C6	C8	C1
L	500	600	800	1200
N	3	3	4	4
M	3	3	4	4
G	2	2	3	3

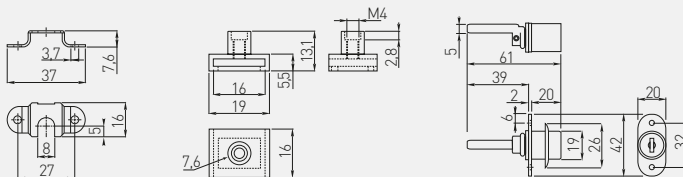

Model	Length (mm)	Finish	Material
ZZ-C5-288-01-S	500	chrom / chrome / хром	ZnAl, stal / ZnAl, steel / ZnAl, сталь
ZZ-C6-288-01-S	600		
ZZ-C8-288-01-S	800		
ZZ-C1-288-01-S	1200		
ZZ-SP-105-05	-	srebrny / silver / серебристый	stal, plastik / steel, plastic / сталь, пластмасса
ZZ-SP-KLMASTER	-	chrom / chrome / хром	

Kratka wentylacyjna
Plinth vent
Вентиляционная решётка

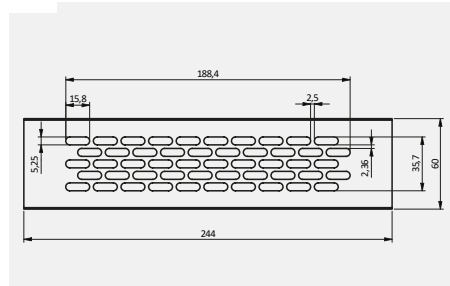

KK-W60245-M0	przepustowość powietrza - 40 cm ² air throughput - 40 cm ²	aluminium / aluminium / алюминий	aluminium aluminium алюминий
KK-W60245-M1		biały / white / белый	
KK-W60245-M2	прохождение воздушного потока - 40 см ²	czarny / black / чёрный	
KK-W60245-M6	stal szorstkowana / brushed steel / шлифованная сталь		



Kratka wentylacyjna D50-80
Plinth vent D50-80
Вентиляционная решётка D50-80

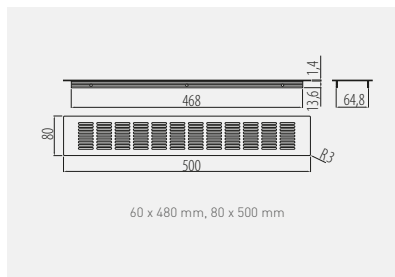
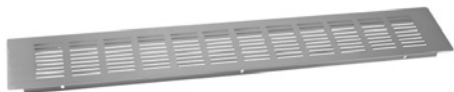

KK-D50-80-06	przepustowość powietrza – 108 cm ² air throughput – 108 cm ² прохождение воздушного потока – 108 см ²	stal szcztokowana brushed steel шлифованная сталь	aluminium aluminium алюминий



Kratka wentylacyjna D50-100
Plinth vent D50-100
Вентиляционная решётка D50-100

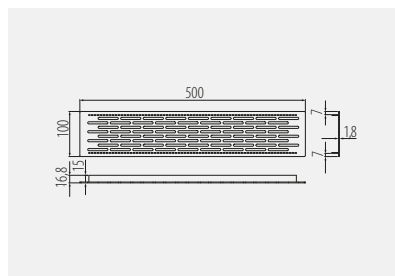

KK-D50100-06	przepustowość powietrza – 130 cm ² air throughput – 130 cm ² прохождение воздушного потока – 130 см ²	stal szcztokowana brushed steel шлифованная сталь	aluminium aluminium алюминий



Kratka wentylacyjna W60
Plinth vent W60
Вентиляционная решётка W60

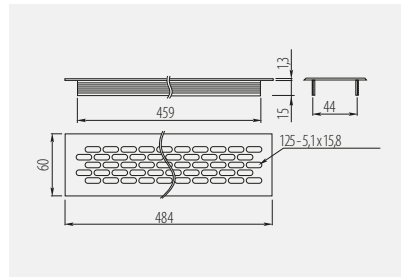

KK-W60800-M0	przepustowość powietrza – 94 cm ² air throughput – 94 cm ² прохождение воздушного потока – 94 см ²	szary / gray / серый	aluminium aluminium алюминий
KK-W60800-M1		biały / white / белый	
KK-W60800-M2		czarny / black / чёрный	



Kratka wentylacyjna W80
Plinth vent W80
Вентиляционная решётка W80

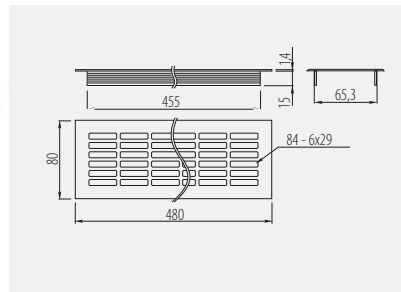





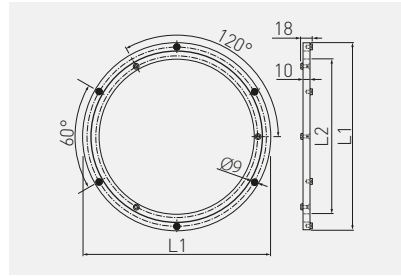

KK-W80800-D0	przepustowość powietrza – 146 cm ² air throughput – 146 cm ² прохождение воздушного потока – 146 см ²	szary / gray / серый	aluminium aluminium алюминий
KK-W80800-D1		biały / white / белый	
KK-W80800-D2		czarny / black / чёрный	



Obrotnica okrągła
Round swivel bracket
Круглый поворотный кронштейн



		 L1 mm	 L2 mm	 kg		
OM-OB0300-05		300	248	60	aluminium aluminium алюминий	aluminium aluminium алюминий
OM-OB0400-05		400	338	100		



Obrotnica kwadratowa
Square swivel bracket
Поворотный кронштейн, квадратный

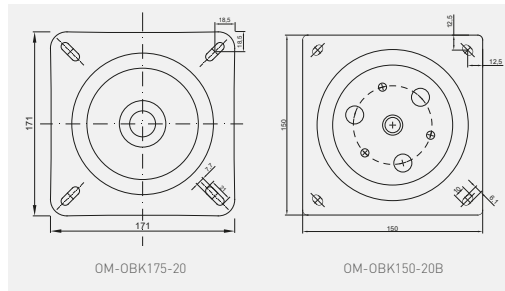

		 kg		
OM-OBK150-20B		50	czarny black чёрный	stal steel сталь
OM-OBK175-20*		100		





MB
KITCHEN

**AKCESORIA DEKORACYJNE
DECORATIVE ACCESSORIES
ЛИЦЕВАЯ ФУРНИТУРА**

Uchwyty Handles Ручки	322 – 411
Wieszaki Hooks Крючки	412 – 429
Wsporniki Shelf supports Полкодержатели	430 – 437
Nóżki meblowe Furniture legs Мебельные ножки	438 – 458
Nogi meblowe Furniture legs Мебельные опоры	459 – 475
Rolki meblowe Furniture castors Мебельные колёсики	476 – 481





Uchwyt MONZA
Handle MONZA
Ручка MONZA

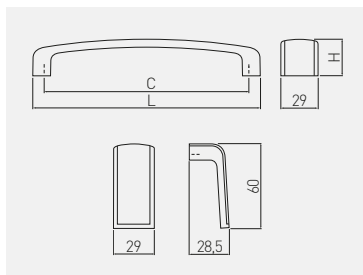

C mm	L mm	H mm				
			stal szcztokowana, chrom brushed steel, chrome шлифованная сталь, хром	biały, chrom white, chrome белый, хром	czarny, chrom black, chrome чёрный, хром	ZnAl, aluminium ZnAl, aluminium ZnAl, алюминий
16	29	28,5	-	UZ-MONZA16-10	-	
160	178	29	UZ-MONZA160-06	UZ-MONZA160-10	UZ-MONZA160-20	
256	274	33	UZ-MONZA256-06	UZ-MONZA256-10	UZ-MONZA256-20	
384	402	34	UZ-MONZA384-06	UZ-MONZA384-10	UZ-MONZA384-20	

Uchwyt MONA
Handle MONA
Ручка MONA

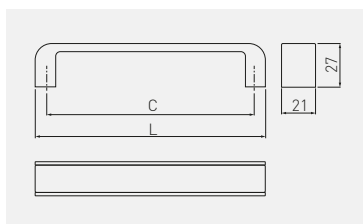

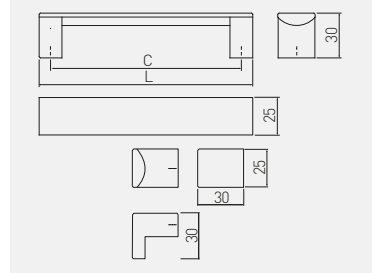

C mm	L mm			
		chrom, biały chrome, white хром, белый	chrom, czarny chrome, black хром, чёрный	ZnAl
128	142	UZ-MONA-128-01-10	UZ-MONA-128-01-20	
192	206	UZ-MONA-192-01-10	UZ-MONA-192-01-20	
256	270	UZ-MONA-256-01-10	UZ-MONA-256-01-20	

Uchwyt ARES
Handle ARES
Ручка ARES



C mm	L mm		
		czarny black чёрный	aluminium aluminium алюминий
96	111	UA-ARS096-20	
128	143	UA-ARS128-20	
160	175	UA-ARS160-20	
192	207	UA-ARS192-20	
224	239	UA-ARS224-20	

C mm	L mm		
		czarny black чёрный	aluminium aluminium алюминий
256	271	UA-ARS256-20	
320	335	UA-ARS320-20	
gatka knob ручка		UA-ARSG30-20	



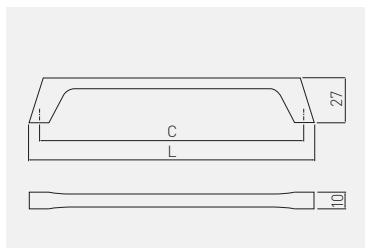

Uchwyt UZ-G2
Handle UZ-G2
Ручка UZ-G2

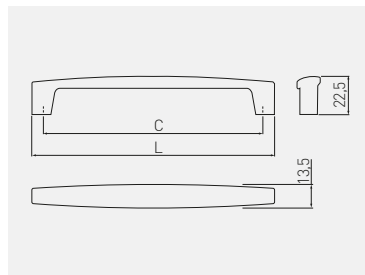

C mm	L mm				
		chrom chrome хром	stal szczotkowana brushed steel шлифованная сталь	czarny mat black matt чёрный матовый	ZnAl
160	172	UZ-G2-160-01	UZ-G2-160-06	UZ-G2-160-20M	
224	236	UZ-G2-224-01	UZ-G2-224-06	UZ-G2-224-20M	

Uchwyt TIVOLI
Handle TIVOLI
Ручка TIVOLI



C mm	L mm				
		chrom chrome хром	czarny chrom black chrome чёрный хром	tytan titanium титан	ZnAl
192	206	UZ-TIVOL-192-01	UZ-TIVOL-192-12	UZ-TIVOL-192-13	
320	334	UZ-TIVOL-320-01	UZ-TIVOL-320-12	UZ-TIVOL-320-13	

Uchwyt BAGIO
Handle BAGIO
Ручка BAGIO

NEW

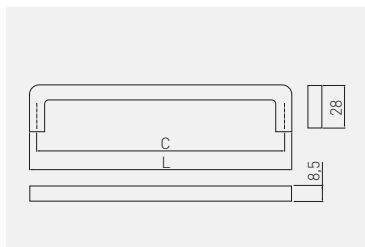

C mm	L mm	chrom chrome хром	antyczny miedź antique brass античная латунь	aluminium aluminium алюминий	stal szorstkowana brushed steel шлифованная сталь	
128	136	UZ-BAGIO-128-01	UZ-BAGIO-128-04	UZ-BAGIO-128-05	UZ-BAGIO-128-06	ZnAl
160	168	UZ-BAGIO-160-01	UZ-BAGIO-160-04	UZ-BAGIO-160-05	UZ-BAGIO-160-06	
192	200	UZ-BAGIO-192-01	UZ-BAGIO-192-04	UZ-BAGIO-192-05	UZ-BAGIO-192-06	
320	328	UZ-BAGIO-320-01	UZ-BAGIO-320-04	UZ-BAGIO-320-05	UZ-BAGIO-320-06	





C mm	L mm	antyczne srebro antique silver античное серебро	tytan szorstkowany brushed titanium шлифованный титан	miedź copper медь	szampan champagne шампань	czarny mat black matt чёрный матовый	
128	136	UZ-BAGIO-128-07	UZ-BAGIO-128-11	UZ-BAGIO-128-15	UZ-BAGIO-128-90	UZ-BAGIO-128-20M	ZnAl
160	168	UZ-BAGIO-160-07	UZ-BAGIO-160-11	UZ-BAGIO-160-15	UZ-BAGIO-160-90	UZ-BAGIO-160-20M	
192	200	UZ-BAGIO-192-07	UZ-BAGIO-192-11	UZ-BAGIO-192-15	UZ-BAGIO-192-90	UZ-BAGIO-192-20M	
320	328	UZ-BAGIO-320-07	UZ-BAGIO-320-11	UZ-BAGIO-320-15	UZ-BAGIO-320-90	UZ-BAGIO-320-20M	

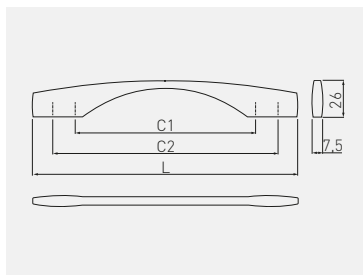

MODERN





Uchwyt ANCONA
Handle ANCONA
Ручка ANCONA

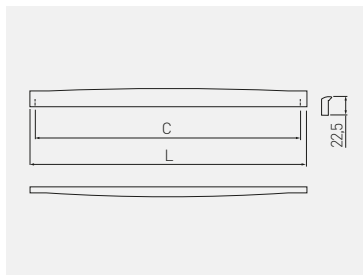

 C1 mm	 C2 mm	 L mm				
			chrom chrome хром	aluminium aluminium алюминий	stal szczotkowana brushed steel шлифованная сталь	ZnAl
128	160	190	UZ-ANCON-128-01	UZ-ANCON-128-05	UZ-ANCON-128-06	
192	224	254	UZ-ANCON-192-01	UZ-ANCON-192-05	UZ-ANCON-192-06	
256	288	318	UZ-ANCON-256-01	UZ-ANCON-256-05	UZ-ANCON-256-06	

Uchwyt KATANIA
Handle KATANIA
Ручка KATANIA



 C mm	 L mm			
		chrom chrome хром	czarny chrom black chrome чёрный хром	ZnAl
320	334	UZ-KATAN-320-01	UZ-KATAN-320-12	

Uchwyt UZ-40
Handle UZ-40
Ручка UZ-40

NEW

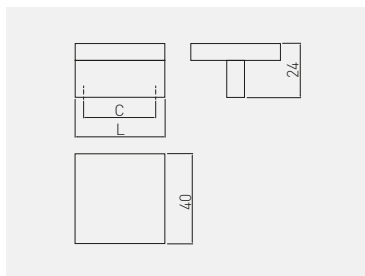

		chrom chrome хром	satyna satin сатин	aluminium aluminium алюминий	stal szczerkowana brushed steel шлифованная сталь	czarny mat black matt чёрный матовый	ZnAl
32	40	UZ-40-032-01	UZ-40-032-02	UZ-40-032-05	UZ-40-032-06	UZ-40-032-20M	

Uchwyt UZ-55
Handle UZ-55
Ручка UZ-55

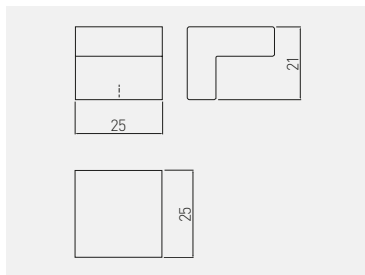

		aluminium aluminium алюминий	ZnAl
gatka knob ручка	25	UZ-55-025-05	

Uchwyt UZ-60
Handle UZ-60
Ручка UZ-60

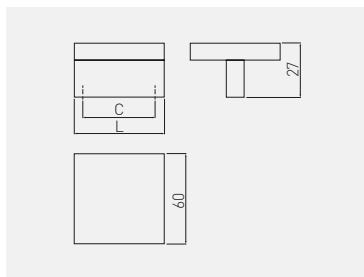
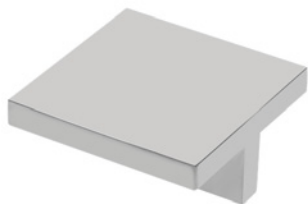

C mm	L mm		
		chrom chrome хром	ZnAl
32	60	UZ-60-032-01	

Uchwyt UZ-133
Handle UZ-133
Ручка UZ-133

NEW

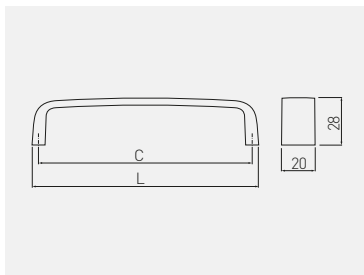

C mm	L mm						
		chrom chrome хром	satyna satin сатин	aluminium aluminium алюминий	stal szcztokowana brushed steel шлифованная сталь	czarny mat black matt чёрный матовый	ZnAl
128	135	UZ-133128-01	UZ-133128-02	UZ-133128-05	UZ-133128-06	UZ-133128-20M	

Uchwyt MODENA
Handle MODENA
Ручка MODENA

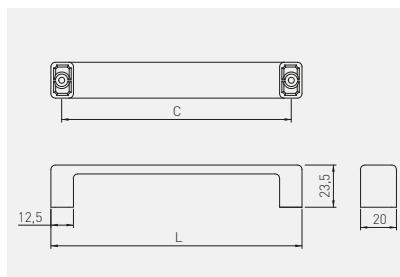

C mm	L mm	chrom chrome хром	aluminium aluminium алюминий	stal szczotkowana brushed steel шлифованная сталь	czarny mat black matt чёрный матовый	ZnAl
128	140	UZ-MODEN-128-01	UZ-MODEN-128-05	UZ-MODEN-128-06	UZ-MODEN-128-20M	
160	172	UZ-MODEN-160-01	UZ-MODEN-160-05	UZ-MODEN-160-06	UZ-MODEN-160-20M	
192	204	UZ-MODEN-192-01	UZ-MODEN-192-05	UZ-MODEN-192-06	UZ-MODEN-192-20M	



Uchwyt UZ-334
Handle UZ-334
Ручка UZ-334

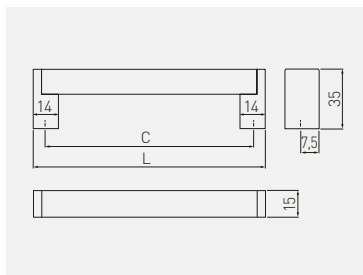

C mm	L mm		
		stal szczotkowana brushed steel шлифованная сталь	ZnAl, stal ZnAl, steel ZnAl, сталь
128	144	UZ-334128-06	
160	175	UZ-334160-06	
192	206	UZ-334192-06	
256	272	UZ-334256-06	
320	335	UZ-334320-06	

Uchwyt UZ-336
Handle UZ-336
Ручка UZ-336

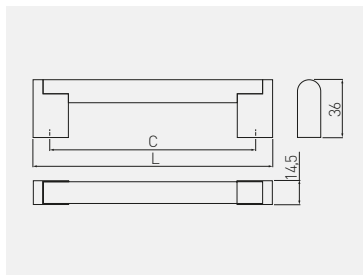

C mm	L mm		
		stal szczotkowana brushed steel шлифованная сталь	ZnAl, stal ZnAl, steel ZnAl, сталь
128	148	UZ-336128-06	
160	182	UZ-336160-06	
192	213	UZ-336192-06	
256	276	UZ-336256-06	
320	340	UZ-336320-06	
416	436	UZ-336416-06	
480	500	UZ-336480-06	

Uchwyt UZ-682
Handle UZ-682
Ручка UZ-682

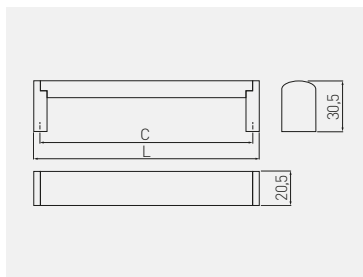

C mm	L mm		
		stal szorstkowana brushed steel шлифованная сталь	stal, ZnAl steel, ZnAl сталь, ZnAl
128	136	UZ-682128-06	
160	170	UZ-682160-06	
192	209	UZ-682192-06	
224	232	UZ-682224-06	

C mm	L mm		
		stal szorstkowana brushed steel шлифованная сталь	stal, ZnAl steel, ZnAl сталь, ZnAl
256	266	UZ-682256-06	
320	329	UZ-682320-06	
416	425	UZ-682416-06	
480	489	UZ-682480-06	

Uchwyt MILANO
Handle MILANO
Ручка MILANO

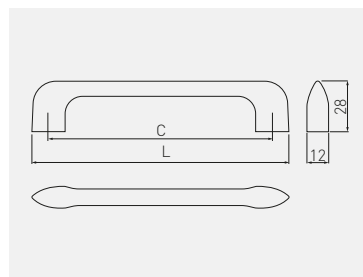

C mm	L mm					
C	L	chrom chrome хром	aluminium aluminium алюминий	stal szorstkowana brushed steel шлифованная сталь	czarny mat black matt чёрный матовый	ZnAl
128	146	UZ-MILAN-128-01	UZ-MILAN-128-05	UZ-MILAN-128-06	UZ-MILAN-128-20M	
256	274	UZ-MILAN-256-01	UZ-MILAN-256-05	UZ-MILAN-256-06	UZ-MILAN-256-20M	
gatka knob ручка		-	-	-	GZ-MILAN-32-20M	

Uchwyt OCTAVIO
Handle OCTAVIO
Ручка OCTAVIO

NEW

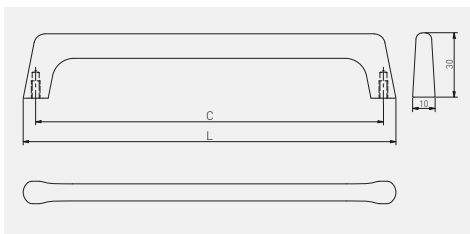

C
mm L
mm



C	L	chrom chrome хром	mosiądz brass латунь	stal szczotkowana brushed steel шлифованная сталь	złoty szczotkowany brushed gold матовое золото	czarny mat black matt чёрный матовый	
128	139	UZ-OCTAVIO-128-01	UZ-OCTAVIO-128-03	UZ-OCTAVIO-128-06	UZ-OCTAVIO-128-18	UZ-OCTAVIO-128-20M	ZnAl
160	171	UZ-OCTAVIO-160-01	UZ-OCTAVIO-160-03	UZ-OCTAVIO-160-06	UZ-OCTAVIO-160-18	UZ-OCTAVIO-160-20M	
192	203	UZ-OCTAVIO-192-01	UZ-OCTAVIO-192-03	UZ-OCTAVIO-192-06	UZ-OCTAVIO-192-18	UZ-OCTAVIO-192-20M	



Uchwyt CAPRI
Handle CAPRI
Ручка CAPRI

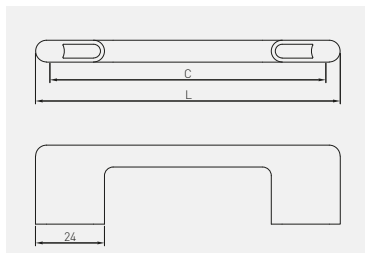

C	L	chrom chrome хром	satyna satin сатин	aluminium aluminium алюминий	stal szczerkowana brushed steel шлифованная сталь	czarny mat black matt чёрный матовый	ZnAl
96	106	UZ-CAPRI-96-01	UZ-CAPRI-96-02	UZ-CAPRI-96-05	UZ-CAPRI-96-06	UZ-CAPRI-96-20M	
128	138	UZ-CAPRI-128-01	UZ-CAPRI-128-02	UZ-CAPRI-128-05	UZ-CAPRI-128-06	UZ-CAPRI-128-20M	
160	170	UZ-CAPRI-160-01	UZ-CAPRI-160-02	UZ-CAPRI-160-05	UZ-CAPRI-160-06	UZ-CAPRI-160-20M	
192	202	UZ-CAPRI-192-01	UZ-CAPRI-192-02	UZ-CAPRI-192-05	UZ-CAPRI-192-06	UZ-CAPRI-192-20M	
256	266	UZ-CAPRI-256-01	UZ-CAPRI-256-02	UZ-CAPRI-256-05	UZ-CAPRI-256-06	UZ-CAPRI-256-20M	
320	330	UZ-CAPRI-320-01	UZ-CAPRI-320-02	UZ-CAPRI-320-05	UZ-CAPRI-320-06	UZ-CAPRI-320-20M	



Uchwyt UZ-819
Handle UZ-819
Ручка UZ-819

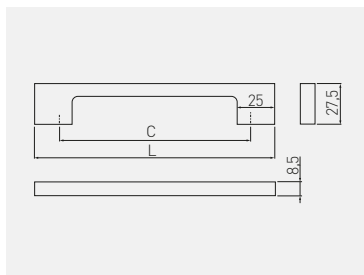

C	L	chrom chrome хром	satyna satin сатин	aluminium aluminium алюминий	stal szczotkowana brushed steel шлифованная сталь	antyczne srebro antique silver античное серебро	biały white белый	
96	129	UZ-819096-01	UZ-819096-02	UZ-819096-05	UZ-819096-06	UZ-819096-07	UZ-819096-10	ZnAl
128	161	UZ-819128-01	UZ-819128-02	UZ-819128-05	UZ-819128-06	UZ-819128-07	UZ-819128-10	
160	193	UZ-819160-01	UZ-819160-02	UZ-819160-05	UZ-819160-06	UZ-819160-07	UZ-819160-10	
192	225	UZ-819192-01	UZ-819192-02	UZ-819192-05	UZ-819192-06	UZ-819192-07	UZ-819192-10	
256	289	UZ-819256-01	UZ-819256-02	UZ-819256-05	UZ-819256-06	UZ-819256-07	UZ-819256-10	
320	353	UZ-819320-01	UZ-819320-02	UZ-819320-05	UZ-819320-06	UZ-819320-07	UZ-819320-10	



C	L	czarny chrom black chrome чёрный хром	antyczna miedź antique copper античная медь	miedź copper медь	złoty mosiądz gold brass золотая латунь	czarny black чёрный	
96	129	UZ-819096-12	UZ-819096-14	-	-	UZ-819096-20	ZnAl
128	161	UZ-819128-12	UZ-819128-14	UZ-819128-15	UZ-819128-16	UZ-819128-20	
160	193	UZ-819160-12	UZ-819160-14	UZ-819160-15	UZ-819160-16	UZ-819160-20	
192	225	UZ-819192-12	UZ-819192-14	UZ-819192-15	UZ-819192-16	UZ-819192-20	
256	289	UZ-819256-12	UZ-819256-14	UZ-819256-15	UZ-819256-16	UZ-819256-20	
320	353	UZ-819320-12	UZ-819320-14	-	-	UZ-819320-20	



antyczna miedź
antique copper
античная медь



miedź
copper
медь



złoty mosiądz
gold brass
золотая латунь



Gatka SPOT
Knob SPOT
Ручка SPOT

NEW

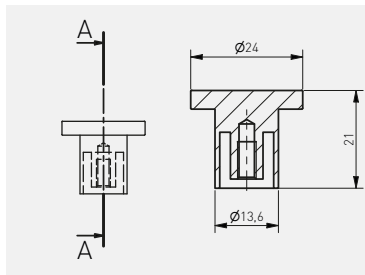

	stal szczotkowana brushed steel шлифованная сталь	złoty szczotkowany brushed gold матовое золото	czarny mat black matt чёрный матовый	
gatka knob ручка	GZ-SPOT-1-06	GZ-SPOT-1-18	GZ-SPOT-1-20M	ZnAl

Uchwyt CLEO
Handle CLEO
Ручка CLEO

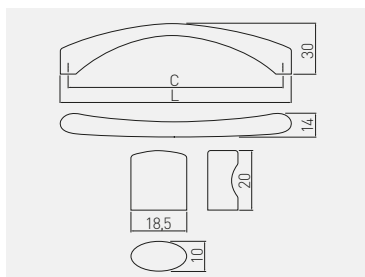

C
mm

L
mm



		chrom chrome хром	aluminium aluminium алюминий	stal szczotkowana brushed steel шлифованная сталь	
128	137	UZ-CLEO-128-01	UZ-CLEO-128-05	UZ-CLEO-128-06	ZnAl
160	169	UZ-CLEO-160-01	UZ-CLEO-160-05	UZ-CLEO-160-06	
192	201	UZ-CLEO-192-01	UZ-CLEO-192-05	UZ-CLEO-192-06	



Uchwyt PRATO
Handle PRATO
Ручка PRATO

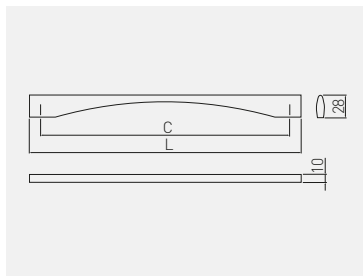

C mm	L mm			
		chrom chrome хром	stal szcztkowana brushed steel шлифованная сталь	ZnAl
160	189	UZ-PRATO-160-01	UZ-PRATO-160-06	
320	349	UZ-PRATO-320-01	UZ-PRATO-320-06	

Uchwyt UA-B311
Handle UA-B311
Ручка UA-B311

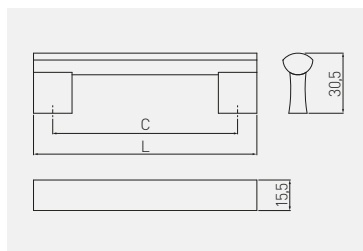

C mm	L mm				
		chrom chrome хром	aluminium aluminium алюминий	czarny black чёрный	aluminium aluminium алюминий
96	116	UA-B31109601*	UA-B0-311096	UA-B0-311096-20M	
128	148	UA-B31112801	UA-B0-311128	UA-B0-311128-20M	
160	180	UA-B31116001	UA-B0-311160	UA-B0-311160-20M	
192	212	UA-B31119201	UA-B0-311192	UA-B0-311192-20M	
224	244	UA-B31122401	UA-B0-311224	UA-B0-311224-20M	
256	276	UA-B31125601	UA-B0-311256	UA-B0-311256-20M	
288	307	UA-B31128801*	UA-B0-311288	UA-B0-311288-20M*	
320	340	UA-B31132001*	UA-B0-311320	UA-B0-311320-20M	
480	500	UA-B31148001*	UA-B0-311480	UA-B0-311480-20M*	

* Produkt dostępny na indywidualne zamówienie / Available for special orders / Товар доступен под заказ



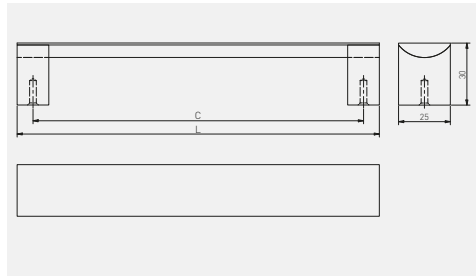

Uchwyt UA-B337
Handle UA-B337
Ручка UA-B337

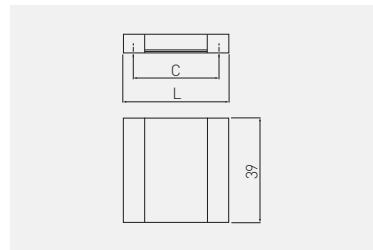

 C mm	 L mm		
		aluminium aluminium алюминий	aluminium aluminium алюминий
128	143	UA-B0-337128	
160	175	UA-B0-337160	
192	207	UA-B0-337192	
224	239	UA-B0-337224	
256	271	UA-B0-337256	
320	335	UA-B0-337320	



Uchwyt UA-114
Handle UA-114
Ручка UA-114



 C mm	 L mm		
		aluminium aluminium алюминий	aluminium aluminium алюминий
32	39	UA-AA-114-05	

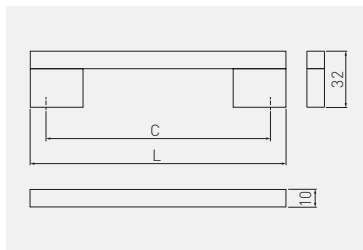



Uchwyt UA-18
Handle UA-18
Ручка UA-18

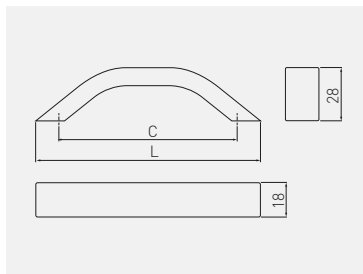

 C mm	 L mm			
		chrom chrome хром	aluminium aluminium алюминий	aluminium aluminium алюминий
128	146	UA-A18128-01	UA-18-128146	
160	178	UA-A18160-01	UA-18-160178	
192	210	UA-A18192-01	UA-18-192210	
224	242	UA-A18224-01	UA-18-224242	
256	274	UA-A18256-01	UA-18-256274	
320	338	UA-A18320-01	UA-18-320338	
400	418	-	UA-18-400418	





Uchwyt UA-313
Handle UA-313
Ручка UA-313

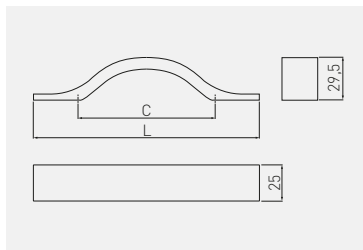

 C mm	 L mm			
		aluminium aluminium алюминий	aluminium aluminium алюминий	
128	150	UA-00-313128		
160	182	UA-00-313160		
192	214	UA-00-313192		





Uchwyt UA-319
Handle UA-319
Ручка UA-319

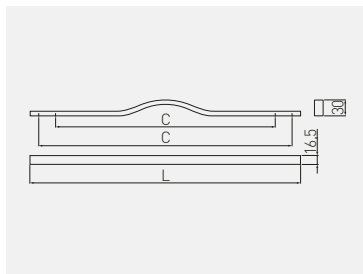

 C mm	 L mm		
		aluminium aluminium алюминий	aluminium aluminium алюминий
96	158	UA-00-319096	
128	189	UA-00-319128	
160	231	UA-00-319160	

Uchwyt DOPPIO
Handle DOPPIO
Ручка DOPPIO



 C mm	 L mm		
		chrom, aluminium chrome, aluminium хром, алюминий	aluminium aluminium алюминий
192 / 224	256	UA-DOPPIO192-01	
416 / 480	512	UA-DOPPIO416-01	

Uchwyt VITO
Handle VITO
Ручка VITO

NEW

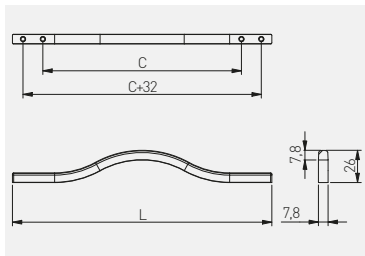

C
mm

L
mm



C mm	L mm	chrom chrome хром	aluminium aluminium алюминий	antyczne srebro antique silver античное серебро	ZnAl
160	210	UZ-VITO-160-01	UZ-VITO-160-05	UZ-VITO-160-07	ZnAl
288	340	UZ-VITO-288-01	UZ-VITO-288-05	UZ-VITO-288-07	

C
mm

L
mm



C mm	L mm	czarny chrom black chrome чёрный хром	złoty mosiądz gold brass золотая латунь	czarny mat black matt чёрный матовый	ZnAl
160	210	UZ-VITO-160-12	UZ-VITO-160-16	UZ-VITO-160-20M	ZnAl
288	340	UZ-VITO-288-12	UZ-VITO-288-16	UZ-VITO-288-20M	

MODERN

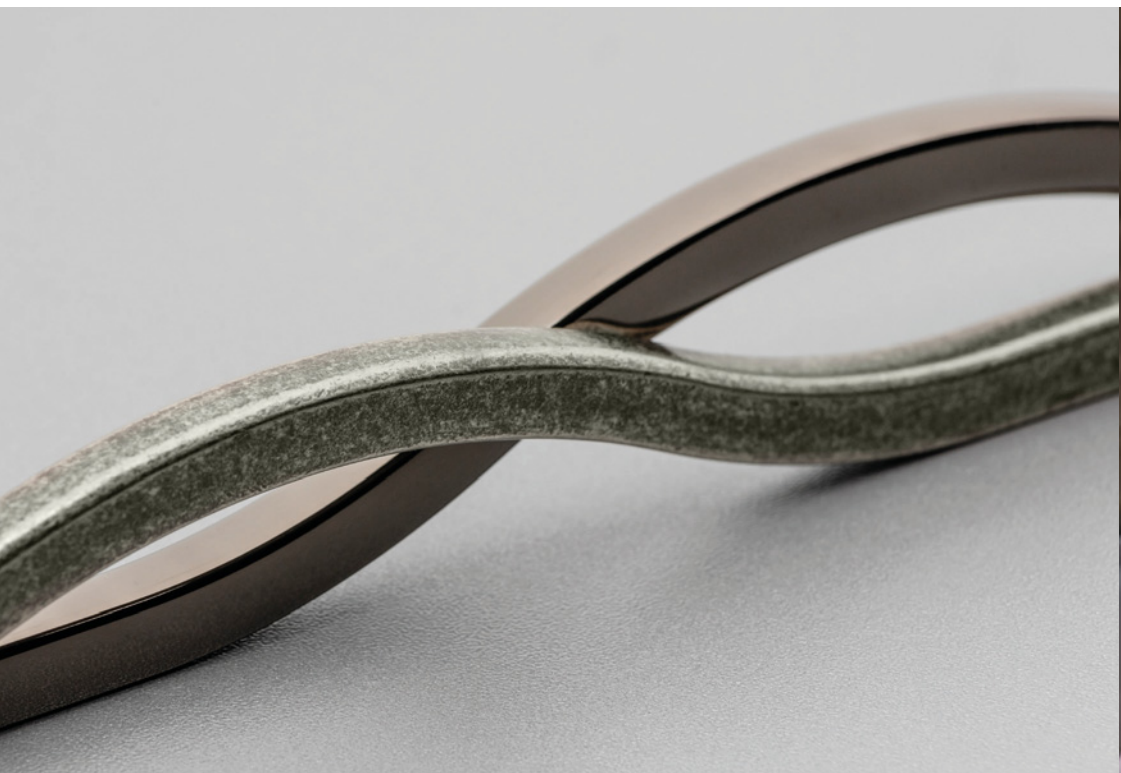

Gatka DUNE
 Knob DUNE
 Ручка DUNE

NEW

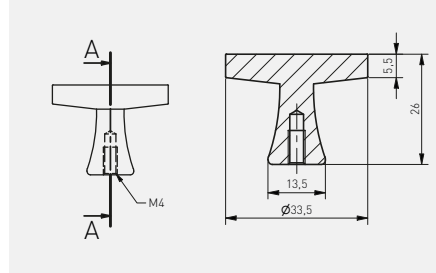

	stal szorstkowana brushed steel шлифованная сталь	złoty mosiądz gold brass золотая латунь	czarny mat black matt чёрный матовый	
gatka knob ручка	GZ-DUNE-1-06	GZ-DUNE-1-16	GZ-DUNE-1-20M	ZnAl

MODERN



Uchwyt FLAVIO
Handle FLAVIO
Ручка FLAVIO

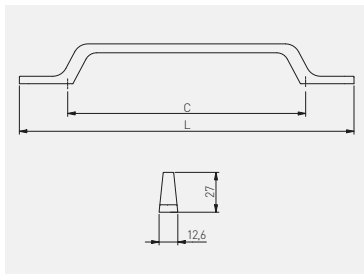

C mm	L mm					
		chrom chrome хром	stal szcztokowana brushed steel шлифованная сталь	zloty mosiadz golden brass золотая латунь	czarny mat black matt чёрный матовый	ZnAl
96	161	UZ-FLAVIO-96-01	UZ-FLAVIO-96-06	UZ-FLAVIO-96-16	UZ-FLAVIO-96-20M	
128	193	UZ-FLAVIO-128-01	UZ-FLAVIO-128-06	UZ-FLAVIO-128-16	UZ-FLAVIO-128-20M	
160	225	UZ-FLAVIO-160-01	UZ-FLAVIO-160-06	UZ-FLAVIO-160-16	UZ-FLAVIO-160-20M	

Uchwyt THIN
Handle THIN
Ручка THIN

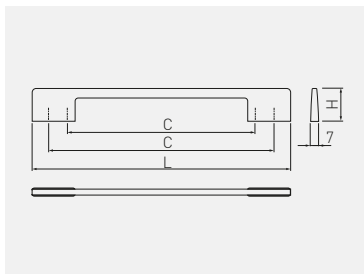

C mm	L mm	H mm				
			chrom chrome хром	aluminium aluminium алюминий	stal szcztokowana brushed steel шлифованная сталь	ZnAl
96/128	156	24	UZ-TH096128-01	UZ-TH096128-05	UZ-TH096128-06	
160/192	220	28	UZ-TH160192-01	UZ-TH160192-05	UZ-TH160192-06	
288/320	348	28	UZ-TH288320-01	-	UZ-TH288320-06	

Uchwyt UA-337
Handle UA-337
Ручка UA-337

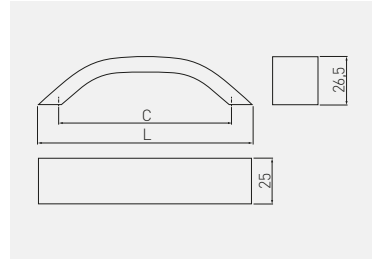

C mm	L mm			
		aluminium aluminium алюминий	czarny black чёрный	aluminium aluminium алюминий
96	116	UA-00-337096	UA-00-337096-20M	
128	146	UA-00-337128	UA-00-337128-20M	
160	180	UA-00-337160	UA-00-337160-20M	
192	212	UA-00-337192	UA-00-337192-20M	
224	244	UA-00-337224	UA-00-337224-20M	
256	275	UA-00-337256	UA-00-337256-20M	
320	340	UA-00-337320	UA-00-337320-20M	

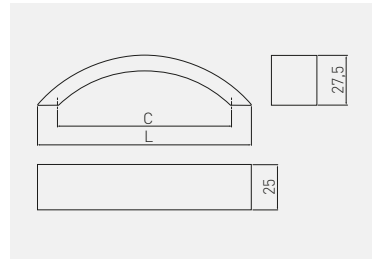

Uchwyt UA-338
Handle UA-338
Ручка UA-338

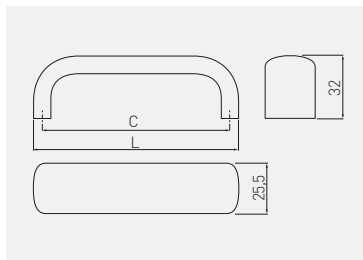

C mm	L mm			
		aluminium aluminium алюминий	aluminium aluminium алюминий	
128	137	UA-00-338128		
160	169	UA-00-338160		

Uchwyt UA-340
Handle UA-340
Ручка UA-340



 C mm	 L mm		
		aluminium aluminium алюминий	aluminium aluminium алюминий
128	137	UA-00-340128	
160	169	UA-00-340160	
192	201	UA-00-340192	
224	233	UA-00-340224	
256	265	UA-00-340256	
320	329	UA-00-340320	



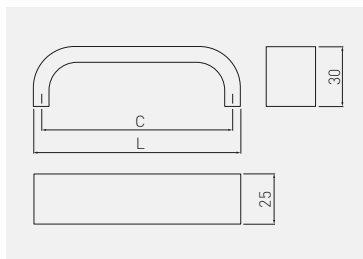

Uchwyt UA-347
Handle UA-347
Ручка UA-347

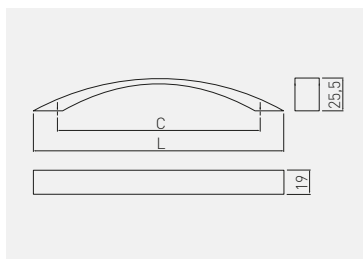

 C mm	 L mm		
		aluminium aluminium алюминий	aluminium aluminium алюминий
128	136	UA-00-347128	
160	168	UA-00-347160	
192	200	UA-00-347192	
224	232	UA-00-347224	
256	264	UA-00-347256	
320	328	UA-00-347320	

Uchwyt CALABRIA
Handle CALABRIA
Ручка CALABRIA



 C mm	 L mm		
		chrom chrome хром	stal szczotkowana brushed steel шлифованная сталь
160	195	UZ-CALABRIA160-01	UZ-CALABRIA160-06
192	224	UZ-CALABRIA192-01	UZ-CALABRIA192-06
224	258	UZ-CALABRIA224-01	UZ-CALABRIA224-06

ZnAl

CLASSIC

Uchwyt GENUA
Handle GENUA
Ручка GENUA

NEW

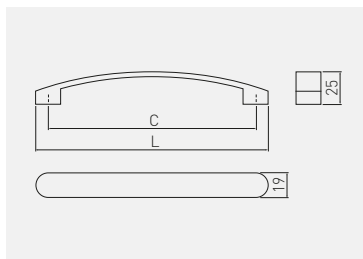

 C mm	 L mm		
		chrom chrome хром	satyna satin сатин
		aluminium aluminium алюминий	czarny mat black matt чёрный матовый
128	148	UZ-GENUA128-01	UZ-GENUA128-02
		UZ-GENUA128-05	UZ-GENUA128-20M
160	180	UZ-GENUA160-01	UZ-GENUA160-02
		UZ-GENUA160-05	UZ-GENUA160-20M

ZnAl

Uchwyt G0
Handle G0
Ручка G0

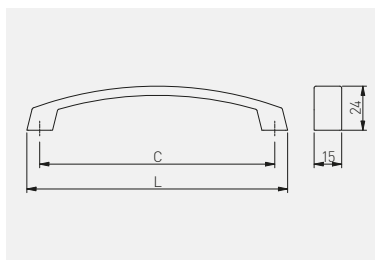

C mm	L mm				
		chrom chrome хром	aluminium aluminium алюминий	stal szczotkowana brushed steel шлифованная сталь	ZnAl
128	142	UZ-G0-128-01	UZ-G0-128-05	UZ-G0-128-06	
160	174	UZ-G0-160-01	UZ-G0-160-05	UZ-G0-160-06	
192	206	UZ-G0-192-01	UZ-G0-192-05	UZ-G0-192-06	
256	270	UZ-G0-256-01	UZ-G0-256-05	UZ-G0-256-06	

Uchwyt UZ-G1
Handle UZ-G1
Ручка UZ-G1

NEW

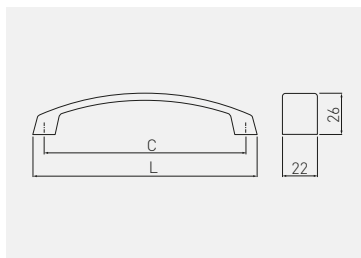

C mm	L mm						
		chrom chrome хром	aluminium aluminium алюминий	stal szczotkowana brushed steel шлифованная сталь	tytan titanium титан	czarny mat black matt чёрный матовый	ZnAl
128	142	UZ-G1-128-01	UZ-G1-128-05	UZ-G1-128-06	UZ-G1-128-13	UZ-G1-128-20M	
160	174	UZ-G1-160-01	UZ-G1-160-05	UZ-G1-160-06	UZ-G1-160-13	UZ-G1-160-20M	
192	206	UZ-G1-192-01	UZ-G1-192-05	UZ-G1-192-06	UZ-G1-192-13	UZ-G1-192-20M	
256	270	UZ-G1-256-01	UZ-G1-256-05	UZ-G1-256-06	UZ-G1-256-13	UZ-G1-256-20M	
320	334	UZ-G1-320-01	UZ-G1-320-05	UZ-G1-320-06	UZ-G1-320-13	UZ-G1-320-20M	
416	430	UZ-G1-416-01	UZ-G1-416-05	UZ-G1-416-06	-	-	

Uchwyt NORD
Handle NORD
Ручка NORD

NEW

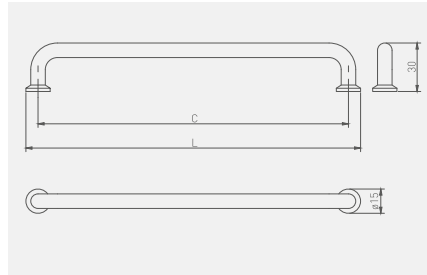

C
mm

L
mm



C	L	mosiądz brass латунь	złoty szcztokowany brushed gold матовое золото	czarny mat black matt чёрный матовый	ZnAl
128	146	UZ-NORD-128-03	UZ-NORD-128-18	UZ-NORD-128-20M	
160	174,5	UZ-NORD-160-03	UZ-NORD-160-18	UZ-NORD-160-20M	
192	212	UZ-NORD-192-03	UZ-NORD-192-18	UZ-NORD-192-20M	
320	334	UZ-NORD-320-03	UZ-NORD-320-18	UZ-NORD-320-20M	
gałka кноп ручка		GZ-NORD-1-03	GZ-NORD-1-18	GZ-NORD-1-20M	

CLASSIC



Uchwyt VENICE
Handle VENICE
Ручка VENICE

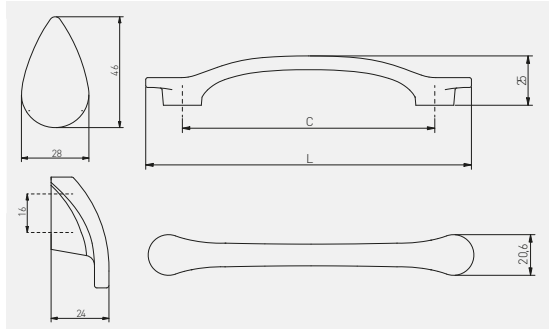

C	L			
128	165	szampan champagne шампань	czarny mat black matt чёрный матовый	ZnAl
gatka knob ручка		GZ-VENICE-1-90	GZ-VENICE-1-20M	



Uchwyt FABRICIO
Handle FABRICIO
Ручка FABRICIO

NEW

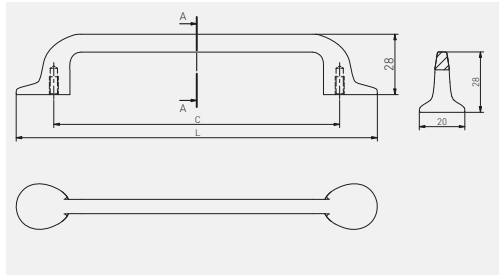

		złoty szczotkowany brushed gold матовое золото	czarny mat black matt чёрный матовый	
128	161	UZ-FABRICIO-128-18	UZ-FABRICIO-128-20M	ZnAl
192	225	UZ-FABRICIO-192-18	UZ-FABRICIO-192-20M	
320	353	UZ-FABRICIO-320-18	UZ-FABRICIO-320-20M	

CLASSIC



Uchwyt OTTO
Handle OTTO
Ручка OTTO

NEW

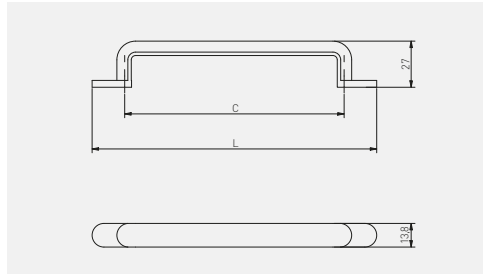

C mm	L mm				
		stal szczotkowana brushed steel шлифованная сталь	szampan champagne шампань	czarny mat black matt чёрный матовый	ZnAl
128	166	UZ-OTTO-128-06	UZ-OTTO-128-90	UZ-OTTO-128-20M	
160	198	UZ-OTTO-160-06	UZ-OTTO-160-90	UZ-OTTO-160-20M	



Uchwyt EVER
Handle EVER
Ручка EVER

NEW

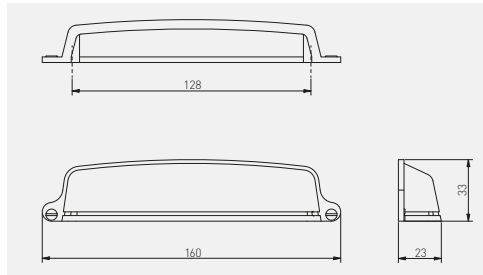

C mm	L mm			
		szampan champagne шампань	czarny mat black matt чёрный матовый	ZnAl
128	160	UZ-EVER-128-90	UZ-EVER-128-20M	

CLASSIC



Gatka POINT
Knob POINT
Ручка POINT

NEW

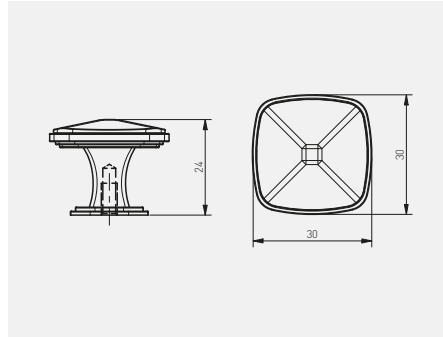

CLASSIC



	stal szczotkowana brushed steel шлифованная сталь	złoty szczotkowany brushed gold матовое золото	czarny mat black matt чёрный матовый	
gatka knob ручка	GZ-POINT-1-06	GZ-POINT-1-18	GZ-POINT-1-20M	ZnAl



Gatka LORENA
Knob LORENA
Ручка LORENA

NEW

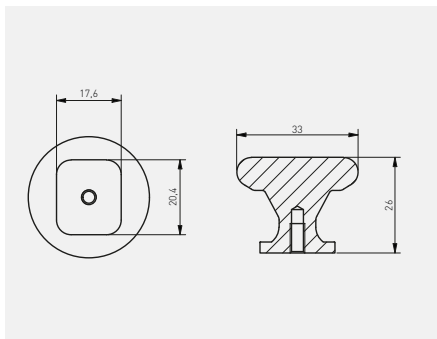

	złoty szczotkowany brushed gold матовое золото	czarny mat black matt чёрный матовый	szczotkowany antracyt brushed anthracite матовое антрацит	
gatka knob ручка	GZ-LORENA-1-18	GZ-LORENA-1-20M	GZ-LORENA-1-21	ZnAl

CLASSIC

Uchwyt STEP
Handle STEP
Ручка STEP

NEW

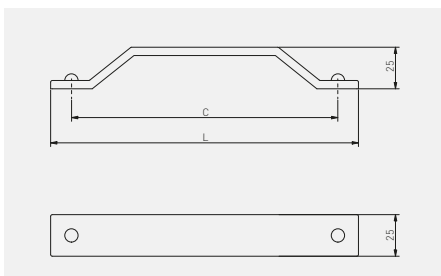



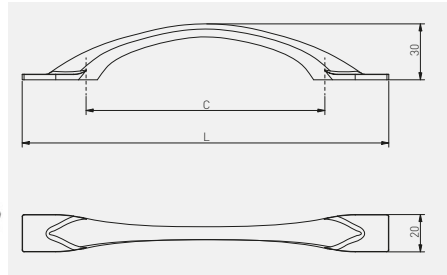

		antyczne srebro antique silver античное серебро	czarny mat black matt чёрный матовый	ZnAl
160	185	UZ-STEP-160-07	UZ-STEP-160-20M	

Uchwyt FLOW
Handle FLOW
Ручка FLOW

NEW



 C mm		 L mm					
		stal szczotkowana brushed steel шлифованная сталь	szampan champagne шампань	czarny mat black matt чёрный матовый	ZnAl		
128	200	UZ-FLOW-128-06	UZ-FLOW-128-90	UZ-FLOW-128-20M			
192	270	UZ-FLOW-192-06	UZ-FLOW-192-90	UZ-FLOW-192-20M			



Uchwyt STILO
Handle STILO
Ручка STILO

NEW

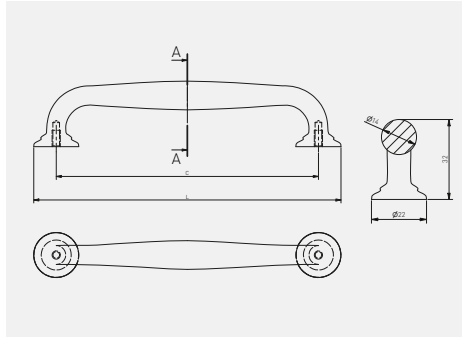

C mm	L mm			
		złoty szczotkowany brushed gold матовое золото	czarny mat black matt чёрный матовый	ZnAl
128	147	UZ-STILO-128-18	UZ-STILO-128-20M	
160	179	UZ-STILO-160-18	UZ-STILO-160-20M	
gatka knob ручка		GZ-STILO-1-18	GZ-STILO-1-20M	

CLASSIC



Uchwyt STRUCTURE
Handle STRUCTURE
Ручка STRUCTURE

NEW

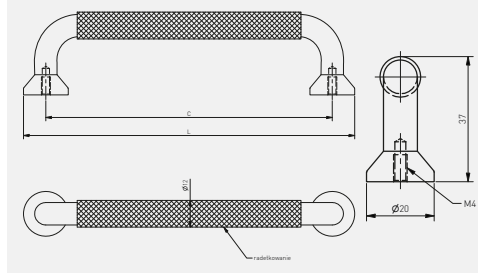

C C C	L L L		
		czarny mat black matt чёрный матовый	Aluminium aluminium aluminio
128	147	UA-STRUCTURE-128-20M	
192	212	UA-STRUCTURE-192-20M	
gatka knob ручка		GA-STRUCTURE-1-20M	

CLASSIC



Uchwyt UZ-01
Handle UZ-01
Ручка UZ-01

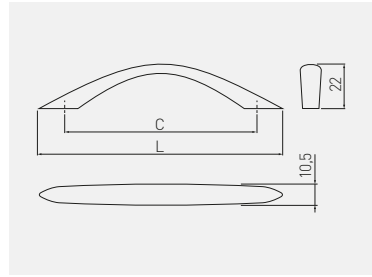

C mm	L mm				
		chrom chrome хром	satyna satin сатин	aluminium aluminium алюминий	ZnAl
96	121	UZ-01-096-01	UZ-01-096-02	UZ-01-096-05	
128	158	UZ-01-128-01	UZ-01-128-02	UZ-01-128-05	

Uchwyt UZ-05
Handle UZ-05
Ручка UZ-05

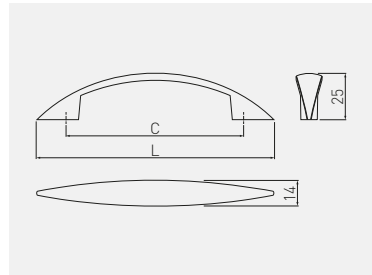

C mm	L mm				
		chrom chrome хром	satyna satin сатин	aluminium aluminium алюминий	ZnAl
96	132	UZ-05-096-01	UZ-05-096-02	UZ-05-096-05	
128	164	UZ-05-128-01	UZ-05-128-02	UZ-05-128-05	

Uchwyt UZ-06
Handle UZ-06
Ручка UZ-06

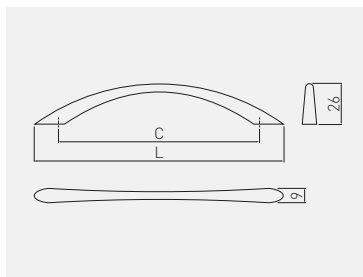

C mm	L mm				
128	164	chrom chrome хром	satyna satin сатин	aluminium aluminium алюминий	ZnAl
		UZ-06-128-01	UZ-06-128-02	UZ-06-128-05	

Uchwyt UZ-07
Handle UZ-07
Ручка UZ-07

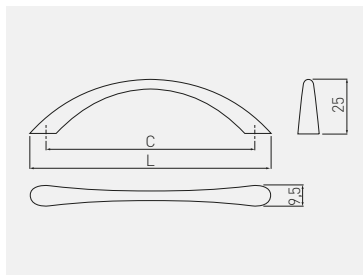



C mm	L mm				
96	111	chrom chrome хром	satyna satin сатин	aluminium aluminium алюминий	ZnAl
		UZ-07-096-01	UZ-07-096-02	UZ-07-096-05	

Uchwyt UZ-Z10
Handle UZ-Z10
Ручка UZ-Z10

NEW

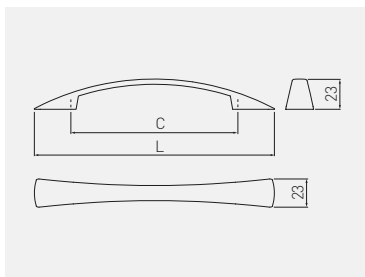
CLASSIC



C mm	L mm					
		chrom chrome хром	satyna satin сатин	aluminium aluminium алюминий	czarny matt black matt чёрный матовый	ZnAl
96	138	UZ-Z10096-01	UZ-Z10096-02	UZ-Z10096-05	UZ-Z10096-20M	
128	184	UZ-Z10128-01	UZ-Z10128-02	UZ-Z10128-05	UZ-Z10128-20M	

Uchwyt UZ-13
Handle UZ-13
Ручка UZ-13

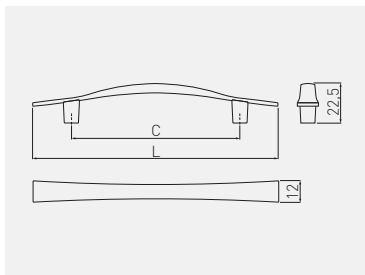

C mm	L mm				
		chrom chrome хром	satyna satin сатин	aluminium aluminium алюминий	ZnAl
96	140	UZ-13-096-01	UZ-13-096-02	UZ-13-096-05	

Uchwyt UZ-14
Handle UZ-14
Ручка UZ-14

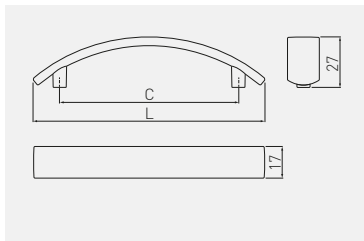

C mm	L mm				
		chrom chrome хром	satyna satin сатин	aluminium aluminium алюминий	ZnAl
96	138	UZ-14-096-01	UZ-14-096-02	UZ-14-096-05	
128	184	UZ-14-128-01	UZ-14-128-02	UZ-14-128-05	

Uchwyt CAMAIO
Handle CAMAIO
Ручка CAMAIO

NEW

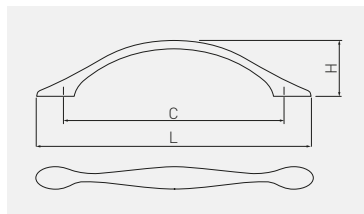

C mm	L mm	H mm				
			chrom chrome хром	satyna satin сатин	stal szcztokowana brushed steel шлифованная сталь	antyczny mosiądz szcztokowany antique brushed brass античная шлифованная латунь
96	126	23	UZ-CAMAI-96-01	UZ-CAMAI-96-02	UZ-CAMAI-96-06	UZ-CAMAI-96-09
128	160	32,5	UZ-CAMAI-128-01	UZ-CAMAI-128-02	UZ-CAMAI-128-06	UZ-CAMAI-128-09

C mm	L mm	H mm					
			biały mat white matt белый матовый	czarny mat black matt чёрный матовый	szampań champagne шампань	czarny chrom black chrome чёрный хром	ZnAl
96	126	23	UZ-CAMAI-96-10M	UZ-CAMAI-96-20M	UZ-CAMAI-96-90	UZ-CAMAI-96-12	
128	160	32,5	UZ-CAMAI-128-10M	UZ-CAMAI-128-20M	UZ-CAMAI-128-90	UZ-CAMAI-128-12	

Gatka BERGAMO
Knob BERGAMO
Ручка BERGAMO

NEW

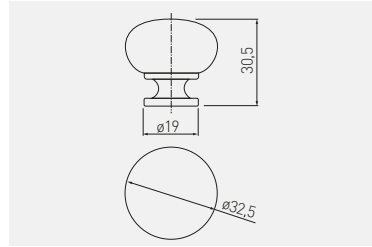

	chrom chrome хром	satyna satin сатин	aluminium aluminium алюминий	stal szczotkowana brushed steel шлифованная сталь	stal steel сталь
gatka knob ручка	GS-BERGA-1-01	GS-BERGA-1-02	GS-BERGA-1-05	GS-BERGA-1-06	



	biały white белый	czarny mat black matt чёрный матовый	czarny chrom black chrome чёрный хром	szampan champagne шампань	stal steel сталь
gatka knob ручка	GS-BERGA-1-10	GS-BERGA-1-20M	GS-BERGA-1-12	GS-BERGA-1-90	



Gatka UDINE
Knob UDINE
Ручка UDINE

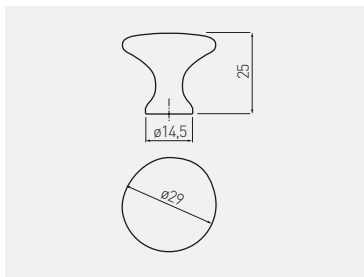

	chrom chrome хром	satyna satin сатин	aluminium aluminium алюминий	stal szcztokowana brushed steel шлифованная сталь	ZnAl
gatka knob ручка	GZ-UDINE-1-01	GZ-UDINE-1-02	GZ-UDINE-1-05	GZ-UDINE-1-06	



	biały mat white matt белый матовый	czarny chrom black chrome чёрный хром	czarny mat black matt чёрный матовый	ZnAl
gatka knob ручка	GZ-UDINE-1-10M	GZ-UDINE-1-12N	GZ-UDINE-1-20M	

Gatka TERNI
Knob TERNI
Ручка TERNI

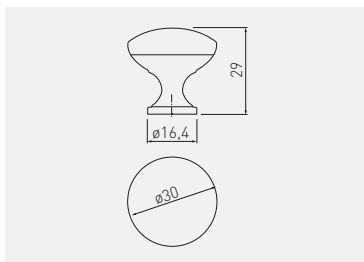



	chrom chrome хром	satyna satin сатин	aluminium aluminium алюминий	stal szcztokowana brushed steel шлифованная сталь	antyczny mosiądz szcztokowany antique brushed brass античная шлифованная латунь
gatka knob ручка	GZ-TERNI-1-01	GZ-TERNI-1-02	GZ-TERNI-1-05	GZ-TERNI-1-06	GZ-TERNI-1-09

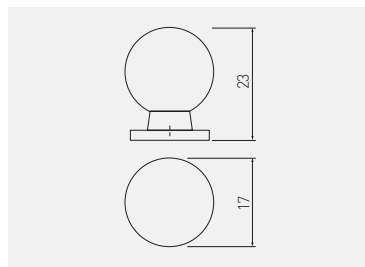

	biały white белый	czarny chrom black chrome чёрный хром	miedź copper медь	złoty mosiądz gold brass золотая латунь	czarny mat black matt чёрный матовый	ZnAl
gatka knob ручка	GZ-TERNI-1-10	GZ-TERNI-1-12	GZ-TERNI-1-15	GZ-TERNI-1-16	GZ-TERNI-1-20M	

Gatka GZ-1155
 Knob GZ-1155
 Ручка GZ-1155



		
	chrom chrome хром	ZnAl
gatka knob ручка	GZ-WP1155-01	

Gatka GZ-ZH
 Knob GZ-ZH
 Ручка GZ-ZH

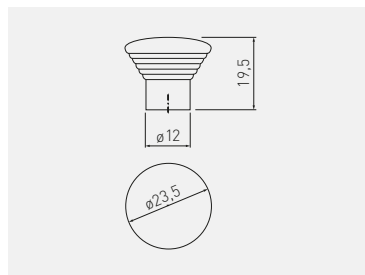

		
	aluminium aluminium алюминий	ZnAl
gatka knob ручка	GZ-ZH-011-05A	

Uchwyt RELING RS
Handle RELING RS
Ручка RELING RS

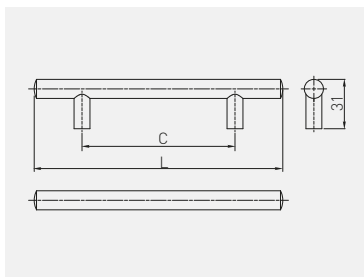

		chrom chrome хром	satyna satin сатин	aluminium aluminium алюминий	stal szczotkowana brushed steel шлифованная сталь	antyczna miedź antique copper античная медь	
96	156	RS-156096-01	RS-156096-02	RS-156096-05	RS-156096-06	RS-156096-14	stal steel сталь
128	188	RS-188128-01	RS-188128-02	RS-188128-05	RS-188128-06	RS-188128-14	
160	220	RS-220160-01	RS-220160-02	RS-220160-05	RS-220160-06	RS-220160-14	
192	272	RS-272192-01	RS-272192-02	RS-272192-05	RS-272192-06	RS-272192-14	
224	304	RS-304224-01	RS-304224-02	RS-304224-05	RS-304224-06	RS-304224-14	
256	336	RS-336256-01	RS-336256-02	RS-336256-05	RS-336256-06	RS-336256-14	
288	368	RS-368288-01	RS-368288-02	RS-368288-05	RS-368288-06	RS-368288-14*	
320	400	RS-400320-01	RS-400320-02	RS-400320-05	RS-400320-06	RS-400320-14	



		stal szczotkowana brushed steel шлифованная сталь	czarny mat black matt чёрный матовый	
96	156	-	ID-RS-E-15696-20M*	stal steel сталь
128	188	-	ID-RS-E-188128-20M*	
160	220	ID-RS-E-220160-06*	ID-RS-E-220160-20M*	
192	272	ID-RS-E-272192-06*	ID-RS-E-272192-20M*	
224	304	ID-RS-E-304224-06*	ID-RS-E-304224-20M*	
256	336	ID-RS-E-336256-06*	ID-RS-E-336256-20M*	
288	368	ID-RS-E-368288-06*	ID-RS-E-368288-20M*	
320	400	ID-RS-E-400320-06*	ID-RS-E-400320-20M*	

Na indywidualne zamówienie dostępne również rozstawy:
352, 384, 416, 480, 512, 544, 576, 608, 640, 672, 704, 736,
768, 800 (mm).

Other sizes available as special-order items:
352, 384, 416, 480, 512, 544, 576, 608, 640, 672, 704, 736,
768, 800 (mm).

Под заказ доступны ручки с межцентровым расстоянием:
352, 384, 416, 480, 512, 544, 576, 608, 640, 672, 704, 736,
768, 800 (мм).

antyczna miedź
antique copper
античная медь



* Produkt dostępny na indywidualne zamówienie / Available for special orders / Товар доступен под заказ

Istnieje możliwość zakupu dodatkowych rozstawów i kolorów na zamówienie indywidualne / Additional spacings and colours can be purchased on individual order / По индивидуальному заказу можно приобрести дополнительные размеры и цвета



Uchwyt TRIEST
Handle TRIEST
Ручка TRIEST

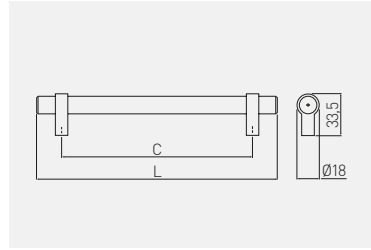

 C mm	 L mm		
		stal szcztokowana brushed steel шлифованная сталь	
96	136	RS-TRIES-96-06	stal, ZnAl steel, ZnAl сталь, ZnAl
128	168	RS-TRIES-128-06	
160	200	RS-TRIES-160-06	
192	232	RS-TRIES-192-06	
256	296	RS-TRIES-256-06	
320	360	RS-TRIES-320-06	



Uchwyt UA-326
Handle UA-326
Ручка UA-326

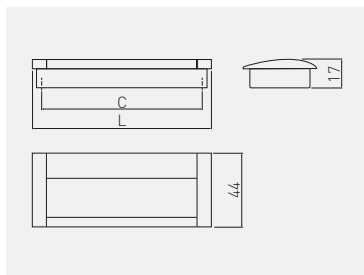
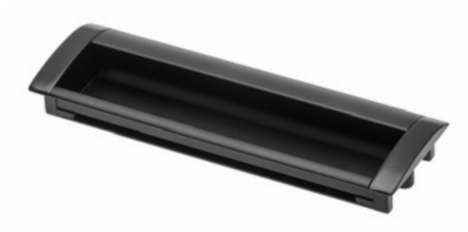

C mm	L mm				
		aluminium / chrom aluminium / chrome алюминий / хром	aluminium aluminium алюминий	czarny black чёрный	aluminium aluminium алюминий
96	108	UA-01-326096-V1	UA-00-326096-05	UA-00-326096-20M	
128	140	UA-01-326128-V1	UA-00-326128-05	UA-00-326128-20M	
160	172	UA-01-326160	UA-00-326160	UA-00-326160-20M	

Uchwyt UZ-E6
Handle UZ-E6
Ручка UZ-E6

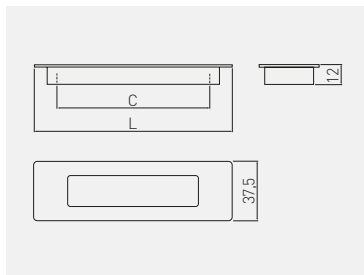

C mm	L mm				
		chrom chrome хром	aluminium aluminium алюминий	stal szcztokowana brushed steel шлифованная сталь	ZnAl
96	124	UZ-E6-096-01	UZ-E6-096-05	UZ-E6-096-06	
128	155	UZ-E6-128-01	UZ-E6-128-05	UZ-E6-128-06	
160	186	UZ-E6-160-01	UZ-E6-160-05	UZ-E6-160-06	

Uchwyt B224
Handle B224
Ручка B224

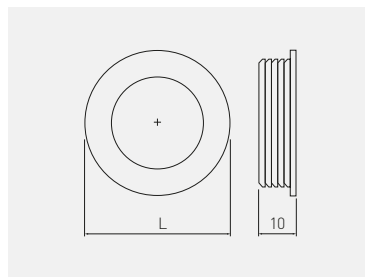

 L mm						
	chrom chrome хром	satyna satin сатин	aluminium aluminium алюминий	biały white белый	czarny black чёрный	ZnAl
40,5	UZ-00B224-01	UZ-00B224-02	UZ-00B224-05	UZ-00B224-10	UZ-00B224-20	

Uchwyt B226
Handle B226
Ручка B226

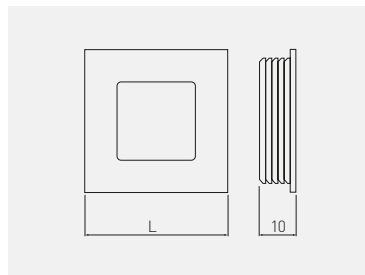
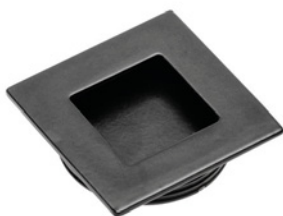

 L mm						
	chrom chrome хром	satyna satin сатин	aluminium aluminium алюминий	biały white белый	czarny black чёрный	ZnAl
40	UZ-00B226-01	UZ-00B226-02	UZ-00B226-05	UZ-00B226-10	UZ-00B226-20	

Uchwyt LIND
Handle LIND
Ручка LIND

NEW

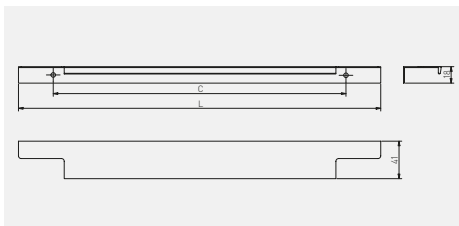

RECESSED

C mm	L mm					
		chrom chrome хром	aluminium aluminium алюминий	złoty szorstkowany brushed gold матовое золото	czarny mat black matt чёрный матовый	aluminium aluminium алюминий
256	296	UA-LIND-256-296-01	UA-LIND-256-296-05	UA-LIND-256-296-18	UA-LIND-256-296-20M	
320	396	UA-LIND-320-396-01	UA-LIND-320-396-05	UA-LIND-320-396-18	UA-LIND-320-396-20M	
224	496*	UA-LIND-224-496-01	UA-LIND-224-496-05	UA-LIND-224-496-18	UA-LIND-224-496-20M	
256	596	UA-LIND-256-596-01	UA-LIND-256-596-05	UA-LIND-256-596-18	UA-LIND-256-596-20M	
352	796	UA-LIND-352-796-01	UA-LIND-352-796-05	UA-LIND-352-796-18	UA-LIND-352-796-20M	





* Mocowanie na 3 wkręty / Mounted with 3 screws / Крепление на 3 самореза

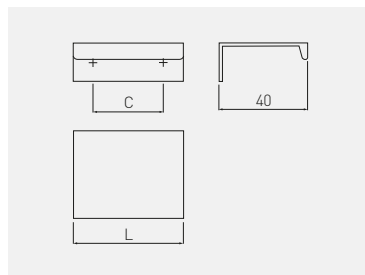

Uchwyt HEXI
Handle HEXI
Ручка HEXI

NEW



 C mm	 L mm					
		chrom chrome хром	aluminium aluminium алюминий	biały mat white matt белый матовый	czarny mat black matt чёрный матовый	aluminium aluminium алюминий
32	50	UA-HEXI-01	UA-HEXI-05	UA-HEXI-10M	UA-HEXI-20M	
96	150	UA-HEXI96-01	UA-HEXI96-05	UA-HEXI96-10M	UA-HEXI96-20M	
160	190	UA-HEXI160-01	UA-HEXI160-05	UA-HEXI160-10M	UA-HEXI160-20M	
192	225	UA-HEXI192-01	UA-HEXI192-05	UA-HEXI192-10M	UA-HEXI192-20M	
256	290	UA-HEXI256-01	UA-HEXI256-05	UA-HEXI256-10M	UA-HEXI256-20M	
320	360	UA-HEXI320-01	UA-HEXI320-05	UA-HEXI320-10M	UA-HEXI320-20M	
do cięcia to cut для резки	3500	-	UA-HEXI-3500-05	-	UA-HEXI-3500-20M	

 C mm	 L mm			
		antracyt anthracite антрацит	złoty szczotkowany brushed gold матовое золото	aluminium aluminium алюминий
32	50	UA-HEXI-60	UA-HEXI-18	
96	150	UA-HEXI96-60	UA-HEXI96-18	
160	190	UA-HEXI160-60	UA-HEXI160-18	
192	225	UA-HEXI192-60	UA-HEXI192-18	
256	290	UA-HEXI290-60	UA-HEXI290-18	
320	360	UA-HEXI360-60	UA-HEXI360-18	



Uchwyt HEXA
Handle HEXA
Ручка HEXA

NEW

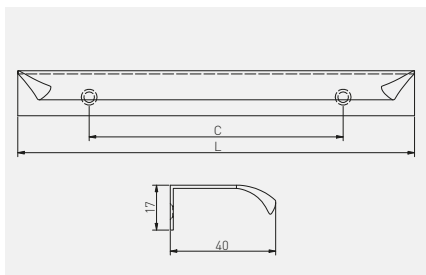

 C mm	 L mm				
		chrom chrome хром	aluminium aluminium алюминий	biały white белый	aluminium aluminium алюминий
32	50	UA-HEXA-32-01	UA-HEXA-32-05	UA-HEXA-32-10M	
96	150	UA-HEXA-96-01	UA-HEXA-96-05	UA-HEXA-96-10M	
192	225	UA-HEXA-192-01	UA-HEXA-192-05	UA-HEXA-192-10M	

 C mm	 L mm			
		złoty szczotkowany brushed gold матовое золото	czarny mat black matt чёрный матовый	aluminium aluminium алюминий
32	50	UA-HEXA-32-18	UA-HEXA-32-20M	
96	150	UA-HEXA-96-18	UA-HEXA-96-20M	
192	225	UA-HEXA-192-18	UA-HEXA-192-20M	



Uchwyt PICADO
Handle PICADO
Ручка PICADO

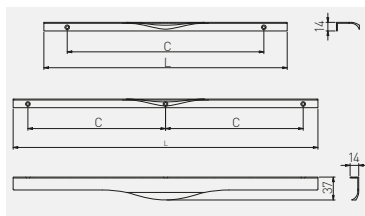

C
mm

L
mm



C mm	L mm	chrom chrome хром	aluminium aluminium алюминий	
256	296	UA-PICADO-256-296-01	UA-PICADO-256-296-05	aluminium aluminium алюминий
320	396	UA-PICADO-320-396-01	UA-PICADO-320-396-05	
2 x 224*	496	UA-PICADO-224-496-01	UA-PICADO-224-496-05	
2 x 256*	596	UA-PICADO-256-596-01	UA-PICADO-256-596-05	
2 x 352*	796	UA-PICADO-352-796-01	UA-PICADO-352-796-05	

C
mm

L
mm



C mm	L mm	złoty szczotkowany brushed gold матовое золото	czarny mat black matt чёрный матовый	
256	296	UA-PICADO-256-296-18	UA-PICADO-256-296-20M	aluminium aluminium алюминий
320	396	UA-PICADO-320-396-18	UA-PICADO-320-396-20M	
2 x 224*	496	UA-PICADO-224-496-18	UA-PICADO-224-496-20M	
2 x 256*	596	UA-PICADO-256-596-18	UA-PICADO-256-596-20M	
2 x 352*	796	UA-PICADO-352-796-18	UA-PICADO-352-796-20M	

* Mocowanie na 3 wkręty / Mounted with 3 screws / Крепление на 3 самореза



Uchwyt FIORD
Handle FIORD
Ручка FIORD

NEW

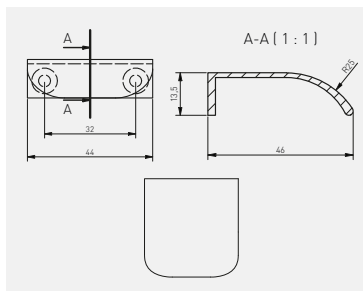
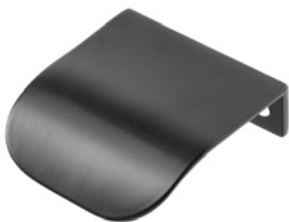

	aluminium aluminium алюминий	stal szczotkowana brushed steel шлифованная сталь	złoto szczotkowane brushed gold матовое золото	czarny mat black matt чёрный матовый	
gatka knob ручка	UZ-FIORD-32-05	UZ-FIORD-32-06	UZ-FIORD-32-18	UZ-FIORD-32-20M	ZnAl

Uchwyt TREX
Handle TREX
Ручка TREX

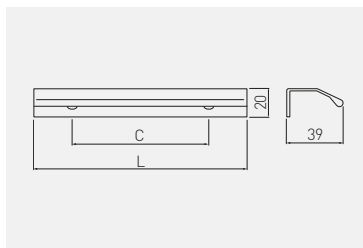
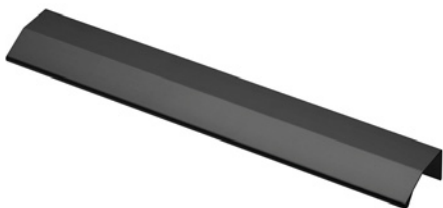

C
mm

L
mm



		aluminium aluminium алюминий	czarny mat black matt чёрный матовый	
32	50	UA-TREX-32-50-05	UA-TREX-32-50-20M	aluminium aluminium алюминий
96	150	UA-TREX-96-150-05	UA-TREX-96-150-20M	
224	250	UA-TREX-224-250-05	UA-TREX-224-250-20M	
320	350	UA-TREX-320-350-05	UA-TREX-320-350-20M	
do cięcia to cut для резки	3500	UA-TREX-3500-05	UA-TREX-3500-20M	

Uchwyt PROFIL C
Handle PROFIL C
Ручка PROFIL C

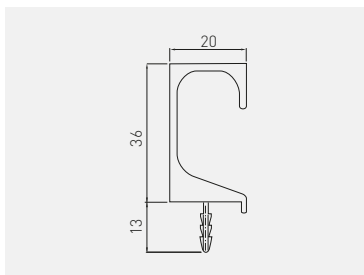

C mm	L mm				
		aluminium aluminium алюминий	stal szczotkowana brushed steel шлифованная сталь	czarny mat black matt чёрный матовый	aluminium aluminium алюминий
do cięcia to cut для резки	3500	PA-0242-35-50	PA-0242-35-50-06	PA-0242-35-50-20M	

Uchwyt PROFIL C2
Handle PROFIL C2
Ручка PROFIL C2

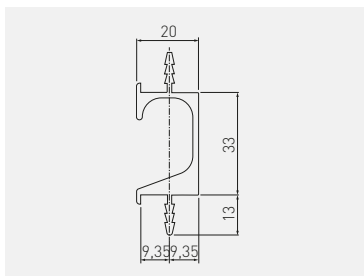
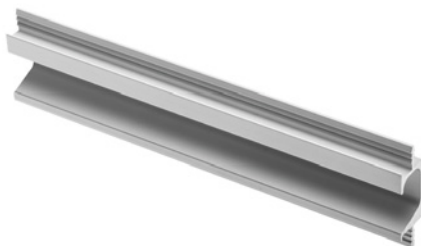

C mm	L mm				
		aluminium aluminium алюминий			aluminium aluminium алюминий
do cięcia to cut для резки	3500	PA-0241-35-50			

Uchwyt PROFIL L
 Handle PROFIL L
 Ручка PROFIL L

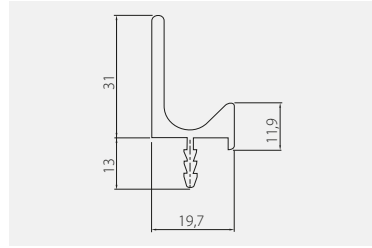

 C mm	 L mm				
do cięcia to cut для резки	3500	aluminium aluminium алюминий	stal szcztokowana brushed steel шлифованная сталь	czarny mat black matt чёрный матовый	aluminium aluminium алюминий
		PA-0243-35-50	PA-0243-35-50-06	PA-0243-35-50-20M	

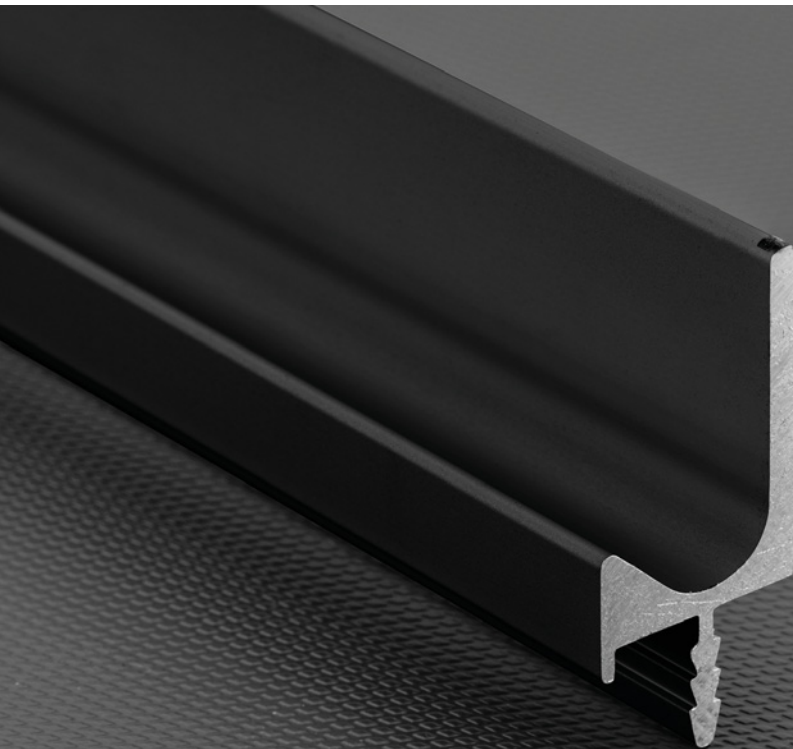

System bezuchwytowy VELLO
 VELLO handleless system
 Безрукоятковая система VELLO

NEW

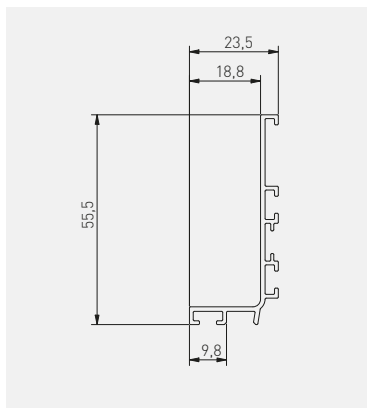

	C mm	L mm					
			aluminium aluminium алюминий	stal szcztokowana brushed steel шлифованная сталь	biały white белый	czarny mat black matt чёрный матовый	aluminium aluminium алюминий
do cięcia to cut для резки	3000		PA-VELLO-L3M-05	PA-VELLO-L3M-06	PA-VELLO-L3M-10	PA-VELLO-L3M-20M	
	4100		PA-VELLO-L4M-05	PA-VELLO-L4M-06	PA-VELLO-L4M-10	PA-VELLO-L4M-20M	

Aksesoria / Accessories / Аксессуары

Ostonki / Covers / Крышки



PA-ZASVELLO-LNL-20M



PA-ZASVELLO-LNP-20M



PA-ZASVELLO-LPL-20M



PA-ZASVELLO-LPP-20M



PA-OSMLGLAXMIC3M-00N

aluminium aluminium алюминий	stal szcztokowana brushed steel шлифованная сталь	biały white белый	czarny mat black matt чёрный матовый	tworzywo plastic пластмасса
PA-ZASVELLO-LNL-05	PA-ZASVELLO-LNL-06	PA-ZASVELLO-LNL-10	PA-ZASVELLO-LNL-20M	
PA-ZASVELLO-LNP-05	PA-ZASVELLO-LNP-06	PA-ZASVELLO-LNP-10	PA-ZASVELLO-LNP-20M	
PA-ZASVELLO-LPL-05	PA-ZASVELLO-LPL-06	PA-ZASVELLO-LPL-10	PA-ZASVELLO-LPL-20M	
PA-ZASVELLO-LPP-05	PA-ZASVELLO-LPP-06	PA-ZASVELLO-LPP-10	PA-ZASVELLO-LPP-20M	



PA-MOUNT-GL-00

Możliwość zastosowania oświetlenia LED. Polecana ostonka PA-OSMLGLAXMIC3M-00N
 Possibility of using LED lighting. Recommended PA-OSMLGLAXMIC3M-00N cover.
 Возможность использования светодиодного освещения. Рекомендуемая заглушка PA-OSMLGLAXMIC3M-00N



System bezuchwytowy VELLO
VELLO handleless system
Безрукоятковая система VELLO

NEW

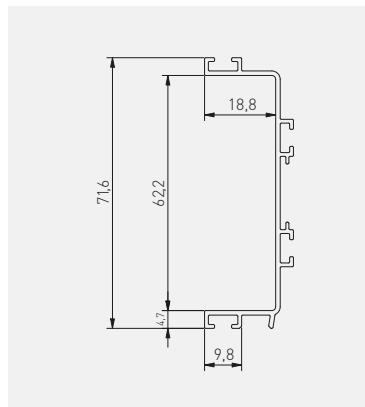

C
mm

L
mm



		aluminium aluminium алюминий	stal szczotkowana brushed steel шлифованная сталь	biały white белый	czarny mat black matt чёрный матовый	aluminium aluminium алюминий
do cięcia to cut для резки	3000	PA-VELLO-C3M-05	PA-VELLO-C3M-06	PA-VELLO-C3M-10	PA-VELLO-C3M-20M	
	4100	PA-VELLO-C4M-05	PA-VELLO-C4M-06	PA-VELLO-C4M-10	PA-VELLO-C4M-20M	

Akcesoria / Accessories / Аксессуары

Ostonki / Covers / Крышки



PA-ZASVELLO-CN-20M



PA-ZASVELO-CP-20M



PA-MOUNT-GL-00



PA-OSMLGLAXMIC3M-00N



aluminium aluminium алюминий	stal szczotkowana brushed steel шлифованная сталь	biały white белый	czarny mat black matt чёрный матовый	tworzywo plastic пластмасса
PA-ZASVELLO-CN-05	PA-ZASVELLO-CN-06	PA-ZASVELLO-CN-10	PA-ZASVELLO-CN-20M	
PA-ZASVELLO-CP-05	PA-ZASVELLO-CP-06	PA-ZASVELO-CP-10	PA-ZASVELO-CP-20M	

Możliwość zastosowania oświetlenia LED. Polecana ostonka PA-OSMLGLAXMIC3M-00N

Possibility of using LED lighting. Recommended PA-OSMLGLAXMIC3M-00N cover.





Возможность использования светодиодного освещения. Рекомендуемая заглушка PA-OSMLGLAXMIC3M-00N

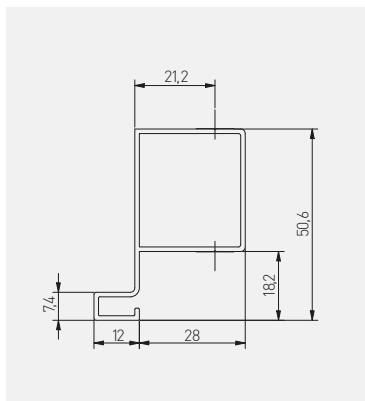

System bezuchwytowy VELLO
 VELLO handleless system
 Безрукоятковая система VELLO

NEW





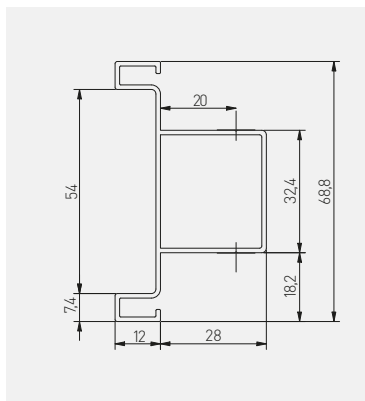

	 C mm	 L mm					
			aluminium aluminium алюминий	stal szczotkowana brushed steel шлифованная сталь	biały white белый	czarny mat black matt чёрный матовый	aluminium aluminium алюминий
do cięcia to cut для резки	3000	PA-VELLO-TJ3M-05	PA-VELLO-TJ3M-06	PA-VELLO-TJ3M-10	PA-VELLO-TJ3M-20M		

System bezuchwytowy VELLO
 VELLO handleless system
 Безрукоятковая система VELLO

NEW



	 C mm	 L mm					
			aluminium aluminium алюминий	stal szcziotkowana brushed steel шлифованная сталь	biały white белый	czarny mat black matt чёрный матовый	
do cięcia to cut для резки	3000		PA-VELLO-TD3M-05	PA-VELLO-TD3M-06	PA-VELLO-TD3M-10	PA-VELLO-TD3M-20M	aluminium aluminium алюминий

Gatka J4
Knob J4
Ручка J4

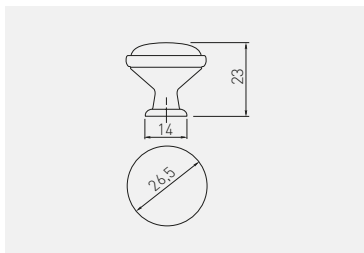

motyw pattern рисунок	antyczny mosiądz antique brass античная латунь	antyczne srebro antique silver старинное серебро	
autumn rose	GP-0728-J4-B	-	ZnAl, porcelana ZnAl, porcelain ZnAl, фарфор
spring flower	GP-0728-J4-R	-	
blue rose	GP-0728-J4-A-04	GP-0728-J4-A-07	
orient gold	GP-0728-J4-C-04	-	



autumn rose



spring flower



blue rose



orient gold

Uchwyt 728B
Handle 728B
Ручка 728B

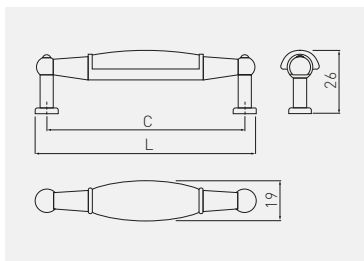

motyw pattern рисунок	C mm	L mm	antyczny mosiądz antique brass античная латунь	
spring flower	96	106	UP-WP0728-BR	ZnAl, porcelana ZnAl, porcelain ZnAl, фарфор
country	96	106	UP-WP0728-BK	
ornament	96	106	UP-WP0728-BX	
autumn rose	96	106	UP-WP0728-BB	



spring flower



country



ornament



autumn rose

Uchwyt 728P
Handle 728P
Ручка 728P

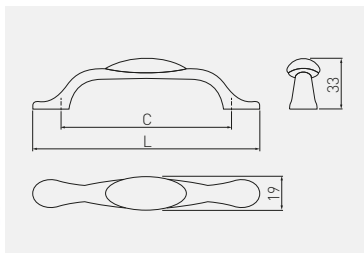

motyw pattern рисунок	C mm	L mm	antyczny mosiądz antique brass античная латунь	antyczne srebro antique silver старинное серебро	ZnAl, porcelana ZnAl, porcelain ZnAl, фарфор
blue rose	96	125	UP-WP0728-PA-04	UP-WP0728-PA-07	
orient gold	96	125	UP-WP0728-PC-04	-	
ornament	96	125	UP-WP0728-PX	-	
autumn rose	96	125	UP-WP0728-PB	-	
spring flower	96	125	UP-WP0728-PR	-	
country	96	125	UP-WP0728-PK	-	
milky	96	125	UP-WP0728-P0	-	



blue rose



orient gold



ornament



autumn rose



spring flower



country



milky

Uchwyt ALATRI
Handle ALATRI
Ручка ALATRI

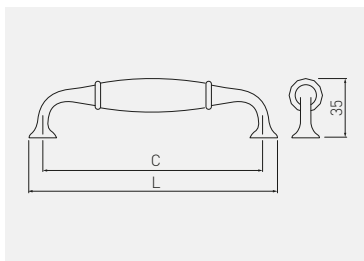

C mm	L mm	antyczny mosiądz antique brass античная латунь	ZnAl, porcelana ZnAl, porcelain ZnAl, фарфор
128	144	UZ-ALATR-128-04	

Uchwyt VASTO
Handle VASTO
Ручка VASTO

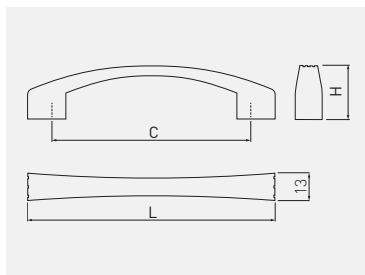

C mm	L mm	H mm		
			antyczny mosiądz szczotkowany antique brushed brass античная шлифованная латунь	ZnAl
96	120	26	UZ-VASTO-96-09	
128	151	27	UZ-VASTO-128-09	

Uchwyt PALERMO
Handle PALERMO
Ручка PALERMO

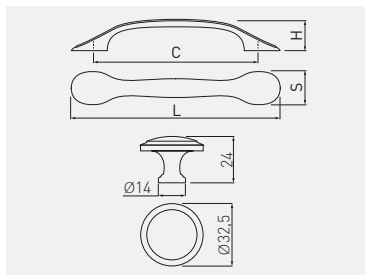

C mm	L mm	H mm	S mm		
				antyczne srebro antique silver античное серебро	ZnAl
96	127	22,5	23	UZ-PALER-96-07	
128	159	23	25	UZ-PALER-128-07	
gatka knob ручка	-	-	-	GZ-PALER-1-07	

Uchwyt UZ-10
Handle UZ-10
Ручка UZ-10

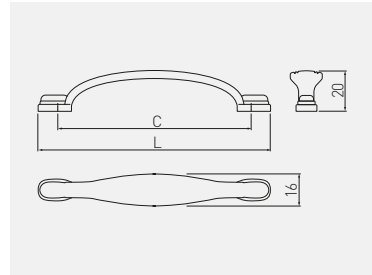

C mm	L mm		
		antyczny mosiądz antique brass античная латунь	ZnAl
96	120	UZ-10-096-N04	

Uchwyt UZ-12
Handle UZ-12
Ручка UZ-12

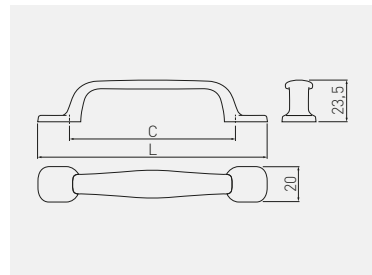

C mm	L mm				
		antyczny mosiądz antique brass античная латунь	antyczne srebro antique silver античное серебро	czarny mat black matt чёрный матовый	ZnAl
96	131	UZ-12-096-04N	UZ-12-096-07	UZ-12-096-20M	

Uchwyt RETRIS
Handle RETRIS
Ручка RETRIS

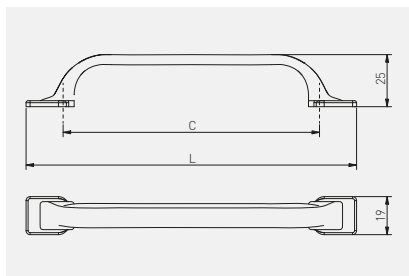

C mm	L mm				
		antyczny mosiądz antique brass античная латунь	antyczne srebro antique silver античное серебро	czarny mat black matt чёрный матовый	ZnAl
128	165	UZ-RETRIS-128-04	UZ-RETRIS-128-07	UZ-RETRIS-128-20M	

Gałka ARDEA
Knob ARDEA
Ручка ARDEA

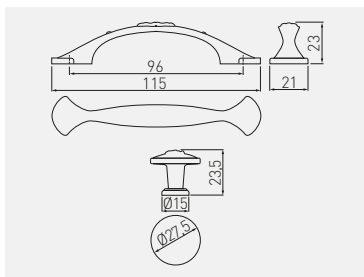

 C mm	 L mm		
		antyczny mosiądz antique brass античная латунь	ZnAl
96	115	UZ-ARDEA-96-09	
gałka knob ручка	-	GZ-ARDEA-1-09	

Uchwyt WERONA
Handle WERONA
Ручка WERONA

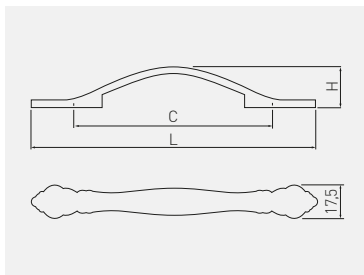

 C mm	 L mm	 H mm				
			antyczny mosiądz antique brass античная латунь	antyczny mosiądz szczotkowany antique brushed brass античная шлифованная латунь	czarny chrom black chrome чёрный хром	ZnAl
96	148	24,5	UZ-WERON-96-04	UZ-WERON-96-09	UZ-WERON-96-12	
128	183	26,5	UZ-WERON-128-04	UZ-WERON-128-09	UZ-WERON-128-12	

Uchwyt ARCHE*
Handle ARCHE*
Ручка ARCHE*

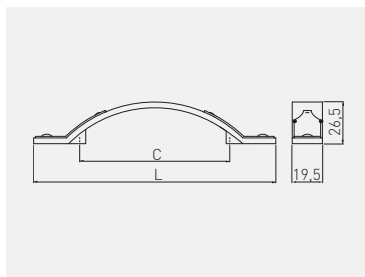

 C mm	 L mm		
96	155	antyczny mosiądz szczotkowany antique brushed brass античная шлифованная латунь	ZnAl
UZ-ARCH096-AEB			

* Produkt dostępny na indywidualne zamówienie / Available for special orders / Товар доступен под заказ

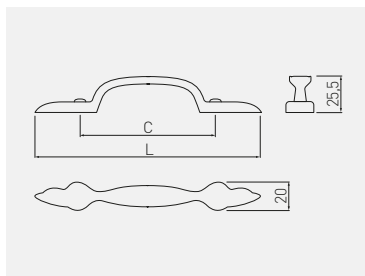

Uchwyt AREZO
Handle AREZO
Ручка AREZO

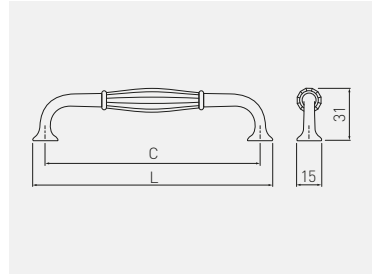

 C mm	 L mm		
96	160	antyczny mosiądz antique brass античная латунь	ZnAl
UZ-AREZO-96-04			

Uchwyt ABIATE
Handle ABIATE
Ручка ABIATE



C mm	L mm		
128	143	antyczny mosiądz antique brass античная латунь	ZnAl
		UZ-ABIAT-128-04	



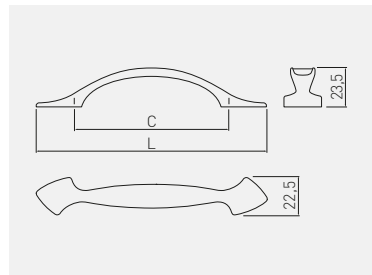

Uchwyt ADRIN
Handle ADRIN
Ручка ADRIN

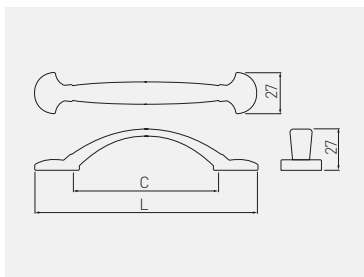

C mm	L mm		
96	139	antyczny mosiądz antique brass античная латунь	ZnAl
		UZ-ADRIN-96-04	

Uchwyt ACERA
Handle ACERA
Ручка ACERA



 C mm	 L mm		
96	147	antyczny mosiądz antique brass античная латунь	ZnAl
UZ-ACERA-96-04			

Uchwyt OLBIA
Handle OLBIA
Ручка OLBIA

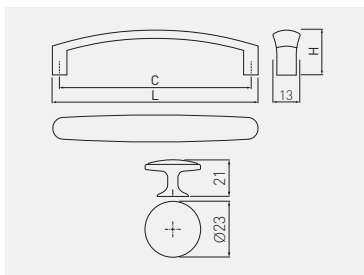

 C mm	 L mm	 H mm		
96	103	22	antyczny mosiądz antique brass античная латунь	ZnAl
128	136	24	UZ-OLBIA-128-04	
gatka knob ручка	-	-	GZ-OLBIA-1-04	

Uchwyt MARSALA
Handle MARSALA
Ручка MARSALA

NEW

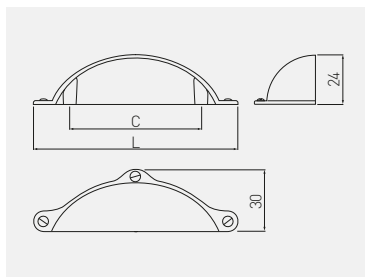

C mm	L mm					
64	99,5	antyczne srebro antique silver античное серебро	antyczny mosiądz szczotkowany antique brushed brass античная шлифованная латунь	biały mat white matt белый матовый	ZnAl	
		UZ-MARSA-64-07	UZ-MARSA-64-09	UZ-MARSA-64-10M		
C mm	L mm					
64	99,5	tytan szczotkowany brushed titanium шлифованный титан	miedź copper медь	złoty szczotkowany brushed gold матовое золото	czarny mat black matt чёрный матовый	ZnAl
		UZ-MARSA-64-11	UZ-MARSA-64-15	UZ-MARSA-64-18	UZ-MARSA-64-20M	



Uchwyt ROYAL
Handle ROYAL
Ручка ROYAL

GZ-ROYAL3-1-10-03

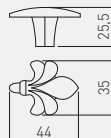

UZ-ROYAL4-96-03

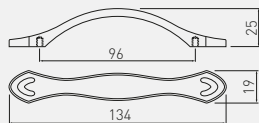

UZ-ROYAL1-96-10-03

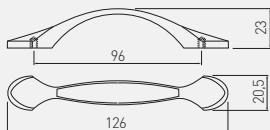

UZ-ROYAL2-96-10-03

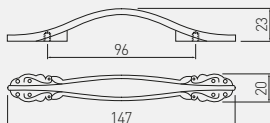

UZ-ROYAL3-96-10-03

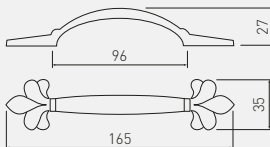

UZ-ROYAL5-128-10-03

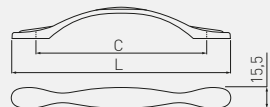

motyw pattern рисунок	C mm	L mm	biały, złoty white, gold белый, золото	ZnAl
latina	96	126	UZ-ROYAL1-96-10-03	ZnAl
werona	96	147	UZ-ROYAL2-96-10-03	
genova	96	165	UZ-ROYAL3-96-10-03	
reggio	96	134	UZ-ROYAL4-96-03	
piano	96	131	UZ-ROYAL5-96-10-03	
	128	164	UZ-ROYAL5-128-10-03	
genova	gatka knob ручка	35	GZ-ROYAL3-1-10-03	

Gatka UZ-WP146
 Knob UZ-WP146
 Ручка UZ-WP146

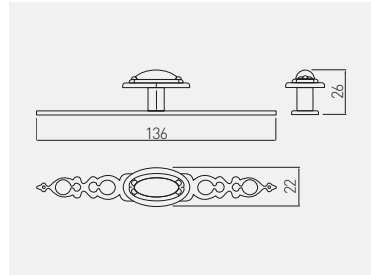

		
	antyczny mosiądz antique brass античная латунь	ZnAl
gatka knob ручка	UZ-WP1146-04	

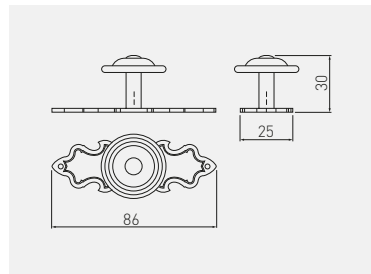

Gatka GZ-1136
 Knob GZ-1136
 Ручка GZ-1136

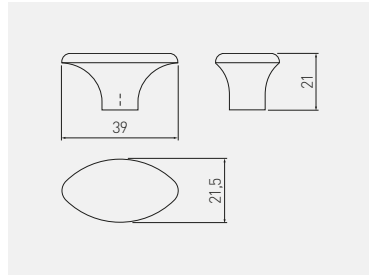

		
	antyczny mosiądz antique brass античная латунь	ZnAl
gatka knob ручка	GZ-WP1136-04	

Gatka GZ-1148
 Knob GZ-1148
 Ручка GZ-1148



	 
	antyczny mosiądz antique brass античная латунь
gatka knob ручка	GZ-WP1148-04 ZnAl

Gatka GZ-1152*
 Knob GZ-1152*
 Ручка GZ-1152*

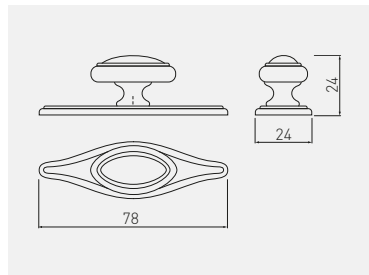

	 
	antyczny mosiądz antique brass античная латунь
gatka knob ручка	GZ-WP1152-04 ZnAl

* Produkt dostępny na indywidualne zamówienie / Available for special orders / Товар доступен под заказ

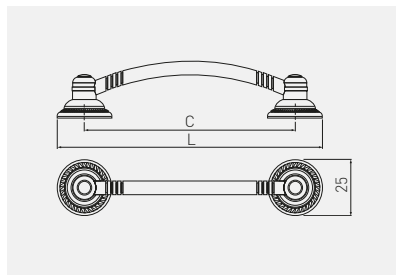

Uchwyt RENNES
Handle RENNES
Ручка RENNES

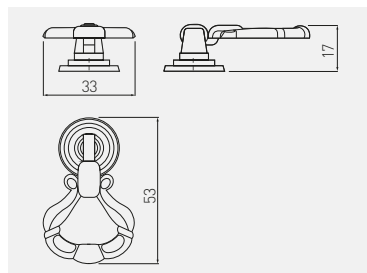

 C mm	 L mm		
96	121	antyczny mosiądz antique brass античная латунь	ZnAl
UZ-REN096-04A			

Kołatka KT-1147
Knocker KT-1147
Ручка KT-1147



		
kołatka knocker ручка	antyczny mosiądz antique brass античная латунь	ZnAl
	KT-WP1147-04	

Gałka CENTO
Knob CENTO
Ручка CENTO

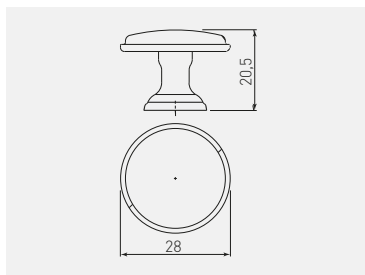

RETRO



	antyczny mosiądz antique brass античная латунь	antyczne srebro antique silver античное серебро	antyczna miedź antique copper античная медь	czarny mat black matt чёрный матовый	ZnAl
gałka knob ручка	GZ-CENTO-1-04	GZ-CENTO-1-07	GZ-CENTO-1-14	GZ-CENTO-1-20M	



Gatka SONET
 Knob SONET
 Ручка SONET

NEW

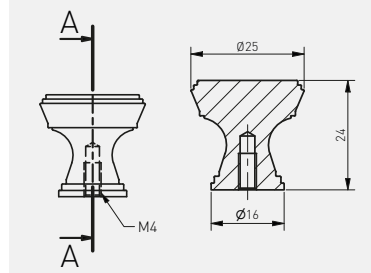

	antyczne srebro antique silver античное серебро	złoty szczotkowany brushed gold матовое золото	czarny mat black matt чёрный матовый	ZnAl
gatka knob ручка	GZ-SONET-1-07	GZ-SONET-1-18	GZ-SONET-1-20M	



Gatka IMPERIA
Knob IMPERIA
Ручка IMPERIA

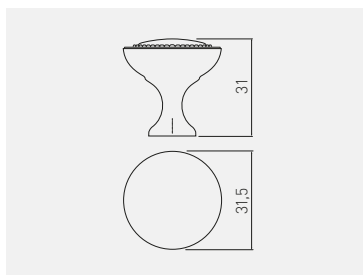

	satyna satin сатин	tytan szcztokowany brushed titanium шлифованный титан	czarny matt black matt чёрный матовый	aluminium aluminium алюминий
gatka knob ручка	GA-IMPER-1-02B	GA-IMPER-1-11	GA-IMPER-1-20M	



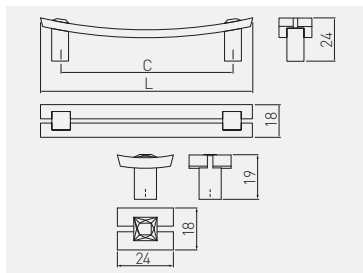

Uchwyt UZ-71C
Handle UZ-71C
Ручка UZ-71C

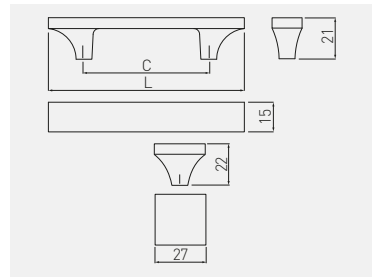

mm	mm	chrom chrome хром	ZnAl, szkto ZnAl, glass ZnAl, стекло
96	118	UZ-71C096-01	
gatka knob ручка		GZ-71C024-01	





Uchwyt UZ-02C
Handle UZ-02C
Ручка UZ-02C

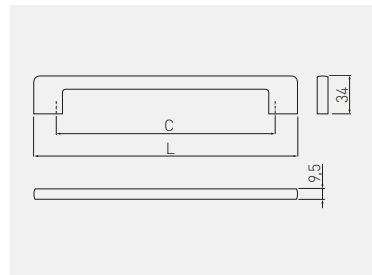

 C mm	 L mm		
		chrom chrome хром	
64	99	UZ-02C064-01	ZnAl, szkło ZnAl, glass ZnAl, стекло
96	135	UZ-02C096-01	
gatka knob ручка	27	UZ-02CF27-01	

Uchwyt UZ-CRA14*
Handle UZ-CRA14*
Ручка UZ-CRA14*





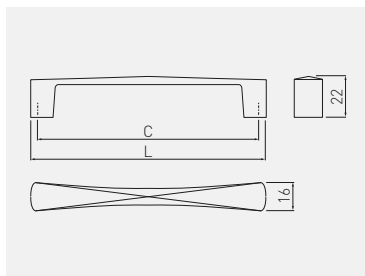

 C mm	 L mm		
		chrom chrome хром	
128	166	UZ-CRA14-128	ZnAl
192	230	UZ-CRA14-192	
320	358	UZ-CRA14-320	

* Produkt dostępny na indywidualne zamówienie / Available for special orders / Товар доступен под заказ







Uchwyt COMO
Handle COMO
Ручка COMO

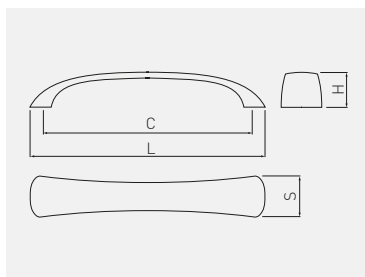

 C mm	 L mm		
		chrom chrome хром	ZnAl
96	104	UZ-COM0096-01	
128	135	UZ-COM0128-01	
160	170	UZ-COM0160-01	





Uchwyt SIENNA
Handle SIENNA
Ручка SIENNA

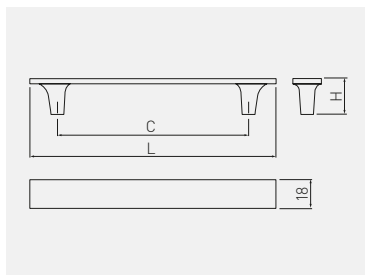
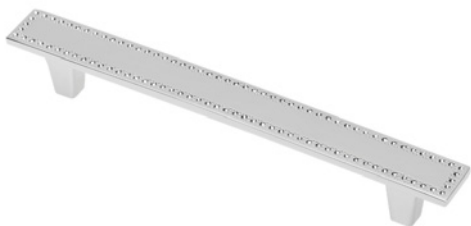

 C mm	 L mm	 H mm	 S mm		
				chrom chrome хром	ZnAl
96	111	21	23,5	UZ-SIENNA096-01	
128	142	23	25	UZ-SIENNA128-01	
160	186	24,5	26,5	UZ-SIENNA160-01	

Uchwyt LUCCA
Handle LUCCA
Ручка LUCCA



 mm	 mm	 mm		
			chrom chrome хром	ZnAl
128	163	23	UZ-LUCCA128-01	
160	196	23	UZ-LUCCA160-01	
192	228	23,5	UZ-LUCCA192-01	

Gatka GZ-CRPA
Knob GZ-CRPA
Ручка GZ-CRPA

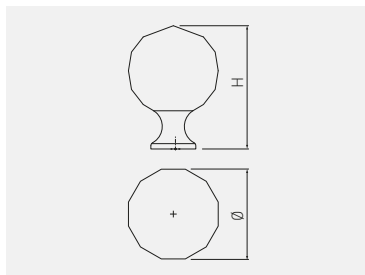

 mm	 mm		
		chrom, biały kryształ chrome, white crystal хром, белый кристалл	chrom, czarny kryształ chrome, black crystal хром, чёрный кристалл
		mosiądz, biały kryształ brass, white crystal латунь, белый кристалл	
20	33	GZ-CRPA20-01	-
25	37	GZ-CRPA25-01	-
30	44	GZ-CRPA30-01	GZ-CRPA30-A1
40	55	GZ-CRPA40-01	-
ZnAl, szkło ZnAl, glass ZnAl, стекло			

Gatka GZ-CRPB
Knob GZ-CRPB
Ручка GZ-CRPB

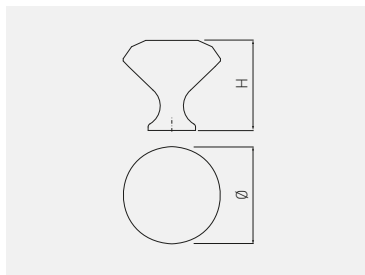

		chrom, biały kryształ chrome, white crystal хром, белый кристалл	chrom, czarny kryształ chrome, black crystal хром, чёрный кристалл	mosiądz, biały kryształ brass, white crystal латунь, белый кристалл	
20	26	GZ-CRPB20-01	-	-	ZnAl, szkło ZnAl, glass ZnAl, стекло
25	28	GZ-CRPB25-01	GZ-CRPB25-A1	-	
30	30	GZ-CRPB30-01	GZ-CRPB30-A1	GZ-CRPB30-03	
40	38	GZ-CRPB40-01	GZ-CRPB40-A1	-	



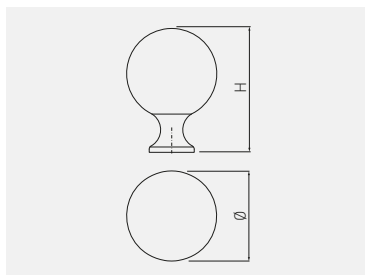

Gatka GZ-CRPC
Knob GZ-CRPC
Ручка GZ-CRPC

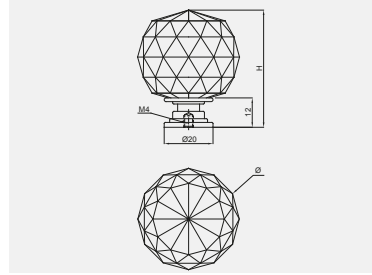

		chrom, biały kryształ chrome, black crystal хром, белый кристалл	ZnAl, szkło ZnAl, glass ZnAl, стекло
30	43	GZ-CRPC30-01	

Gatka GZ-CRPJ
 Knob GZ-CRPJ
 Ручка GZ-CRPJ



 mm	 mm		
		chrom, biały kryształ chrome, black crystal хром, белый кристалл	ZnAl, szkło ZnAl, glass ZnAl, стекло
30	43	ID-GZ-CRPJ30-01	
40	49	ID-GZ-CRPJ40-01	



Uchwyt KID
Handle KID
Ручка KID



BLOCK



CLOUD



STAR



BUTTON



FLAMING



HEART



CROWN



TWITT

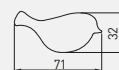
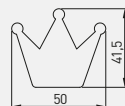
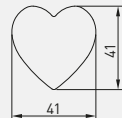
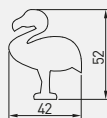
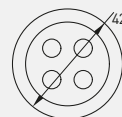
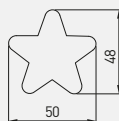
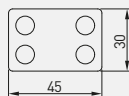

	zielony green зеленый	niebieski blue синий	czerwony red красный	szary grey серый	żółty yellow желтый	różowy pink розовый	
block	UM-BLOCK-ZL	UM-BLOCK-NB	UM-BLOCK-CZ	-	-	-	guma, ZnAl rubber, ZnAl резина, ZnAl
cloud	-	UM-CLOUD-NB	-	UM-CLOUD-SZ	-	-	
star	-	UM-STAR-NB	-	-	UM-STAR-ZT	UM-STAR-RZ	
button	-	UM-BUTTON-NB	-	UM-BUTTON-SZ	-	-	
flaming	-	-	-	UM-FLAMING-SZ	-	UM-FLAMING-RZ	
heart	-	-	-	-	-	UM-HEART-RZ	
crown	-	-	-	-	-	UM-CROWN-RZ	
twitt	UM-TWITT-ZL	-	-	UM-TWITT-SZ	-	-	

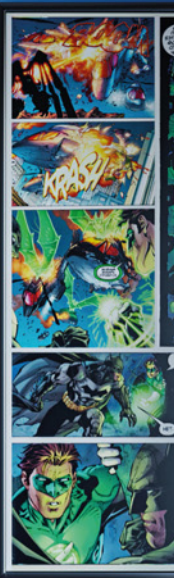

Uchwyt KID WILD
Handle KID WILD
Ручка KID WILD



UM-KID-I-002



UM-KID-P-001



UM-KID-Q-001



UM-KID-U-001

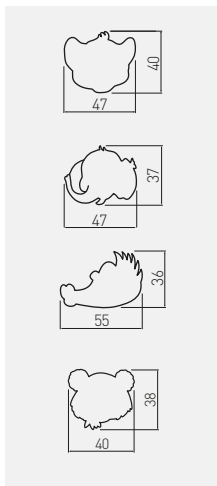

tygrys / tiger / тигр	UM-KID-I-002	guma, ZnAl rubber, ZnAl резина, ZnAl
stoń / elephant / слон	UM-KID-P-001	
krokodyl / crocodile / крокодил	UM-KID-Q-001	
panda / panda / панда	UM-KID-U-001	

Uchwyt KID PLAY
Handle KID PLAY
Ручка KID PLAY



UM-KID-C-001



UM-KID-D-001



UM-KID-E-001

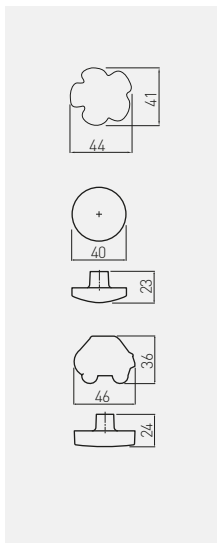

kwiatek / flower / цветок	UM-KID-C-001	guma, ZnAl rubber, ZnAl резина, ZnAl
samochód / car / автомобиль	UM-KID-D-001	
piłka / ball / мяч	UM-KID-E-001	

Uchwyt KID FARM
Handle KID FARM
Ручка KID FARM



UM-KID-W-001



UM-KID-X-001



UM-KID-Z-001



UM-UNICORN-RZ



konik / horse / лошадь	UM-KID-W-001	guma, ZnAl rubber, ZnAl резина, ZnAl
królik / rabbit / кролик	UM-KID-X-001	
piesek / dog / собака	UM-KID-Z-001	
jednorożec / unicorn / единорог	UM-UNICORN-RZ	

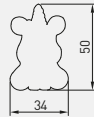

Wieszak 804
Hook 804
Крючок 804

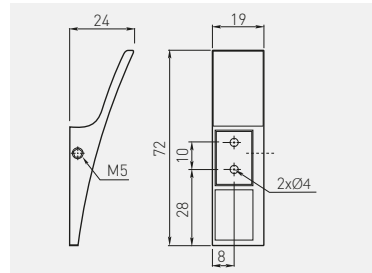

WZ-804-20-01	chrom / chrome / хром	ZnAl
WZ-804-20-05	aluminium / aluminium / алюминий	
WZ-804-20-06	stal szorstkowana / brushed steel / шлифованная сталь	

Wieszak TOLEDO A0
Hook TOLEDO A0
Крючок TOLEDO A0

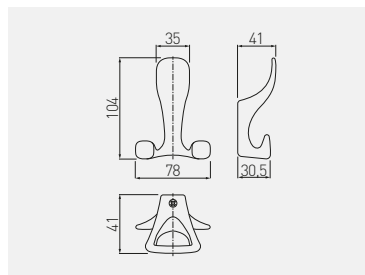

WZ-TOLED-A0-01	chrom / chrome / хром	ZnAl
WZ-TOLED-A0-02	satyna / satin / сатин	
WZ-TOLED-A0-05	aluminium / aluminium / алюминий	
WZ-TOLED-A0-06	stal szczotkowana / brushed steel / шлифованная сталь	
WZ-TOLED-A0-20M	czarny mat / black matt / чёрный матовый	

Wieszak TOLEDO B0
Hook TOLEDO B0
Крючок TOLEDO B0

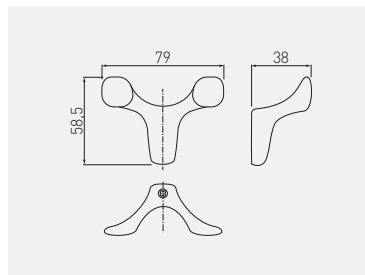

WZ-TOLED-B0-01	chrom / chrome / хром	ZnAl
WZ-TOLED-B0-02	satyna / satin / сатин	
WZ-TOLED-B0-05	aluminium / aluminium / алюминий	
WZ-TOLED-B0-06	stal szczotkowana / brushed steel / шлифованная сталь	
WZ-TOLED-B0-20M	czarny mat / black matt / чёрный матовый	

Wieszak TOLEDO C0
 Hook TOLEDO C0
 Крючок TOLEDO C0

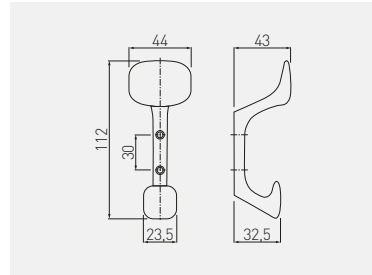

WZ-TOLED-C0-01	chrom / chrome / хром	ZnAl
WZ-TOLED-C0-02	satyna / satin / сатин	
WZ-TOLED-C0-05	aluminium / aluminium / алюминий	
WZ-TOLED-C0-06	stal szczotkowana / brushed steel / шлифованная сталь	
WZ-TOLED-C0-20M	czarny mat / black matt / чёрный матовый	



Wieszak WALENCIA
Hook WALENCIA
Крючок WALENCIA

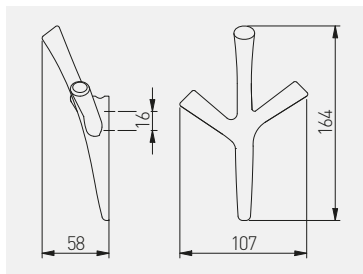

WZ-WALENCIA-01	chrom / chrome / хром	ZnAl
WZ-WALENCIA-06	stal szczotkowana / brushed steel / шлифованная сталь	
WZ-WALENCIA-20M	czarny mat / black matt / чёрный матовый	

Wieszak CORDOBA
Hook CORDOBA
Крючок CORDOBA

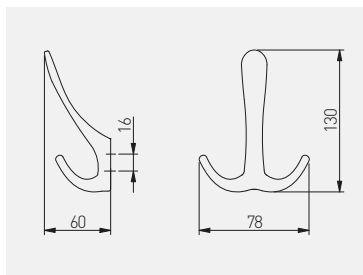

WZ-CORDOBA-01	chrom / chrome / хром	ZnAl
WZ-CORDOBA-06	stal szczotkowana / brushed steel / шлифованная сталь	
WZ-CORDOBA-20M	czarny mat / black matt / чёрный матовый	

Wieszak K2201
Hook K2201
Крючок K2201

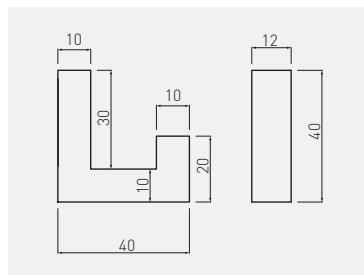

WZ-K2201-01	chrom / chrome / хром	ZnAl
WZ-K2201-06	stal szczotkowana / brushed steel / шлифованная сталь	
WZ-K2201-CZ	czarny / black / чёрный	

Wieszak K2202
Hook K2202
Крючок K2202

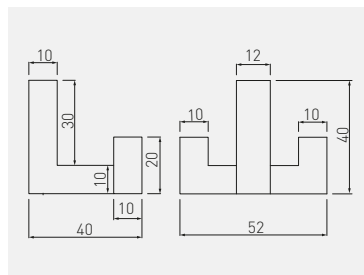

WZ-K2202-01	chrom / chrome / хром	ZnAl
WZ-K2202-06	stal szczotkowana / brushed steel / шлифованная сталь	
WZ-K2202-CZ	czarny / black / чёрный	

Wieszak K23-A0
Hook K23-A0
Крючок K23-A0

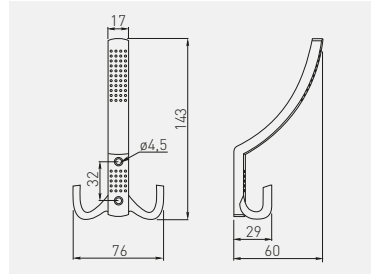

WZ-A0-K23-01	chrom / chrome / хром	ZnAl
WZ-A0-K23-02	satyna / satin / сатин	
WZ-A0-K23-03	mosiądz / brass / латунь	
WZ-A0-K23-04	antyczny mosiądz / antique brass / античная латунь	
WZ-A0-K23-05	aluminium / aluminium / алюминий	
WZ-A0-K23-06*	stal szczotkowana / brushed steel / шлифованная сталь	
WZ-A0-K23-07	antyczne srebro / antique silver / античное серебро	
WZ-A0-K23-20	czarny mat / black matt / чёрный матовый	

* Dostępny na zamówienie / Available only for individual order / Доступен под заказ

Wieszak K23-B0
Hook K23-B0
Крючок K23-B0

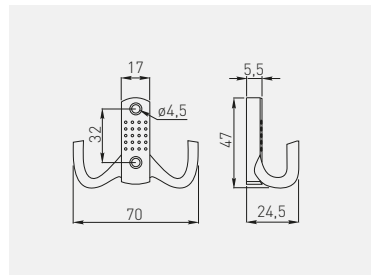

WZ-B0-K23-01	chrom / chrome / хром	ZnAl
WZ-B0-K23-02	satyna / satin / сатин	
WZ-B0-K23-03	mosiądz / brass / латунь	
WZ-B0-K23-04	antyczny mosiądz / antique brass / античная латунь	
WZ-B0-K23-05	aluminium / aluminium / алюминий	
WZ-B0-K23-06*	stal szczotkowana / brushed steel / шлифованная сталь	
WZ-B0-K23-07	antyczne srebro / antique silver / античное серебро	
WZ-B0-K23-20	czarny mat / black matt / чёрный матовый	

* Dostępny na zamówienie / Available only for individual order / Доступен под заказ

Wieszak K23-D1
Hook K23-D1
Крючок K23-D1

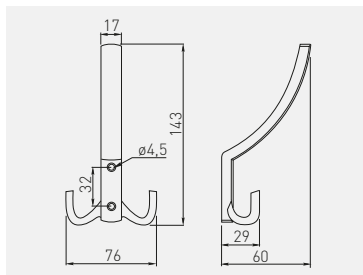

WZ-K23-D1-01	chrom / chrome / хром	ZnAl
WZ-K23-D1-02	satyna / satin / сатин	
WZ-K23-D1-05	aluminium / aluminium / алюминий	
WZ-K23-D1-06	stal szczotkowana / brushed steel / шлифованная сталь	

Wieszak K23-E1
Hook K23-E1
Крючок K23-E1

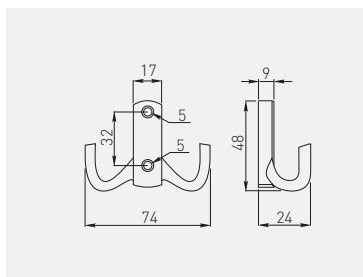

WZ-K23-E1-01	chrom / chrome / хром	ZnAl
WZ-K23-E1-05	aluminium / aluminium / алюминий	
WZ-K23-E1-06	stal szczotkowana / brushed steel / шлифованная сталь	

Wieszak K24-A0
Hook K24-A0
Крючок K24-A0

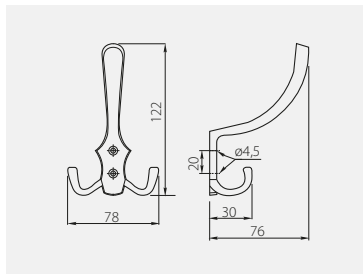

WZ-A0-K24-01	chrom / chrome / хром	ZnAl
WZ-A0-K24-02	satyna / satin / сатин	
WZ-A0-K24-03	mosiądz / brass / латунь	
WZ-A0-K24-04	antyczny mosiądz / antique brass / античная латунь	
WZ-A0-K24-05	aluminium / aluminium / алюминий	
WZ-A0-K24-07	antyczne srebro / antique silver / античное серебро	
WZ-A0-K24-20	czarny mat / black matt / чёрный матовый	

Wieszak K24-B0
Hook K24-B0
Крючок K24-B0

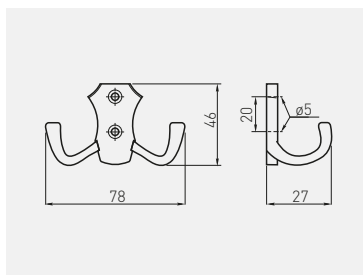

WZ-B0-K24-01	chrom / chrome / хром	ZnAl
WZ-B0-K24-02	satyna / satin / сатин	
WZ-B0-K24-03	mosiądz / brass / латунь	
WZ-B0-K24-04	antyczny mosiądz / antique brass / античная латунь	
WZ-B0-K24-05	aluminium / aluminium / алюминий	
WZ-B0-K24-07	antyczne srebro / antique silver / античное серебро	
WZ-B0-K24-20	czarny mat / black matt / чёрный матовый	



Wieszak K24-C0
Hook K24-C0
Крючок K24-C0

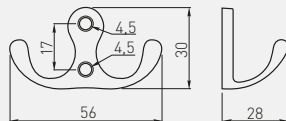

WZ-C0-K24-01	chrom / chrome / хром	ZnAl
WZ-C0-K24-02	satyna / satin / сатин	
WZ-C0-K24-03	mosiądz / brass / латунь	
WZ-C0-K24-04	antyczny mosiądz / antique brass / античная латунь	
WZ-C0-K24-05	aluminium / aluminium / алюминий	
WZ-C0-K24-20	czarny mat / black matt / чёрный матовый	

Wieszak MALAGA A0
Hook MALAGA A0
Крючок MALAGA A0

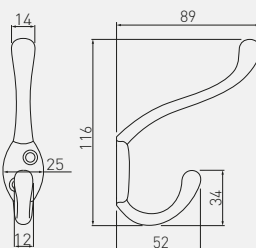

WA-MALAG-A0-01	chrom / chrome / хром	aluminium / aluminium / алюминий
WA-MALAG-A0-02	satyna / satin / сатин	
WA-MALAG-A0-05	aluminium / aluminium / алюминий	
WA-MALAG-A0-20	czarny / black / чёрный	

Wieszak MALAGA B0
Hook MALAGA B0
Крючок MALAGA B0

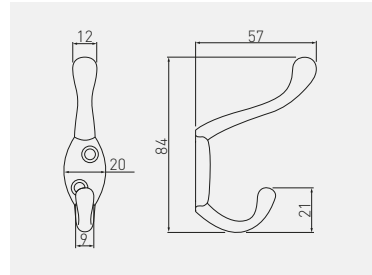

WA-MALAG-B0-01	chrom / chrome / хром	aluminium aluminium алюминий
WA-MALAG-B0-02	satyna / satin / сатин	
WA-MALAG-B0-05	aluminium / aluminium / алюминий	
WA-MALAG-B0-20	czarny / black / чёрный	

Wieszak MALAGA C0
Hook MALAGA C0
Крючок MALAGA C0

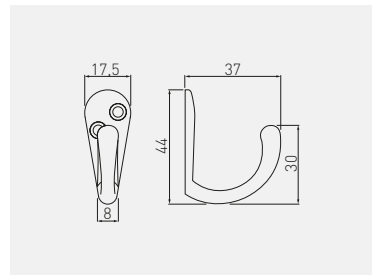

WZ-MALAG-C0-01	chrom / chrome / хром	ZnAl
WZ-MALAG-C0-02	satyna / satin / сатин	
WZ-MALAG-C0-05	aluminium / aluminium / алюминий	
WZ-MALAG-C0-20	czarny / black / чёрный	

Wieszak E18
Hook E18
Крючок E18

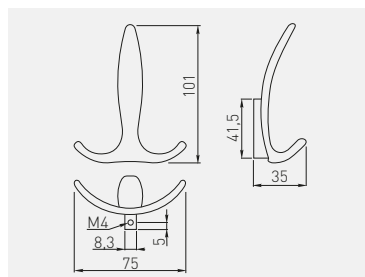

WZ-E-018-01	chrom / chrome / хром	ZnAl
WZ-E-018-02	satyna / satin / сатин	
WZ-E-018-05	aluminium / aluminium / алюминий	
WZ-E-018-06	stal szczotkowana / brushed steel / шлифованная сталь	
WZ-E-018-20M	czarny mat / black matt / чёрный матовый	

Wieszak CORUNA-D
Hook CORUNA-D
Крючок CORUNA-D

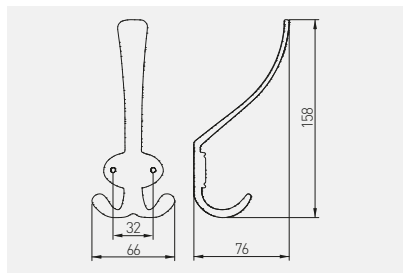

WZ-CORUNA-D-04	antyczny mosiądz / antique brass / античная латунь	ZnAl
WZ-CORUNA-D-07	antyczne srebro / antique silver / античное серебро	
WZ-CORUNA-D-17	brąz / bronze / коричневый	
WZ-CORUNA-D-20M	czarny mat / black matt / чёрный матовый	

Wieszak CORUNA-M
Hook CORUNA-M
Крючок CORUNA-M

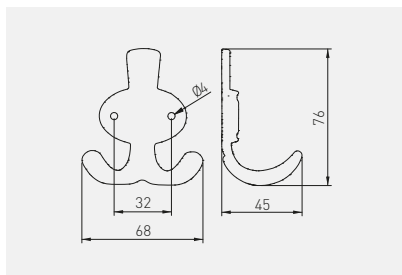

WZ-CORUNA-M-04	antyczny mosiądz / antique brass / античная латунь	ZnAl
WZ-CORUNA-M-07	antyczne srebro / antique silver / античное серебро	
WZ-CORUNA-M-17	brąz / bronze / коричневый	
WZ-CORUNA-M-20M	czarny mat / black matt / чёрный матовый	

Wieszak MADRYT
Hook MADRYT
Крючок MADRYT

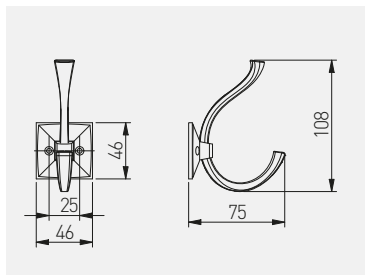

WZ-MADRYT-04	antyczny mosiądz / antique brass / античная латунь	ZnAl
WZ-MADRYT-07	antyczne srebro / antique silver / античное серебро	
WZ-MADRYT-15	antyczna miedź / antique copper / античная медь	
WZ-MADRYT-20M	czarny mat / black matt / чёрный матовый	



Wieszak CAPITAL
Hook CAPITAL
Крючок CAPITAL

NEW

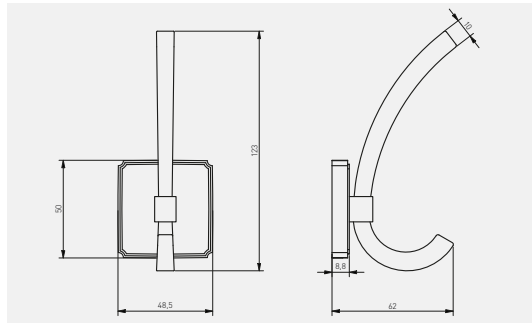

WZ-CAPITAL-18	złoty szczotkowany brushed gold матовое золото	ZnAl
WZ-CAPITAL-20M	czarny mat black matt чёрный матовый	



Wieszak CRAFT
Hook CRAFT
Крючок CRAFT

NEW

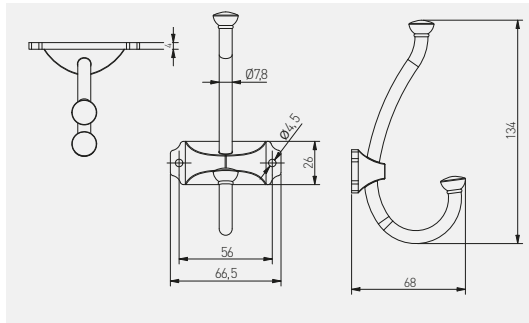

WZ-CRAFT-04	antyczny mosiądz / antique brass / античная латунь	ZnAl
WZ-CRAFT-07	antyczne srebro / antique silver / античное серебро	
WZ-CRAFT-15	antyczna miedź / antique copper / античная медь	
WZ-CRAFT-20M	czarny mat / black matt / чёрный матовый	



Wieszak ORVIETO A0
Hook ORVIETO A0
Крючок ORVIETO A0

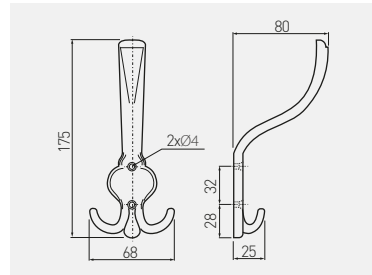

WZ-ORVIE-A0-09

antyczny mosiądz szczotkowany
antique brushed brass
античная шлифованная латунь

ZnAl

Wieszak ORVIETO B0
Hook ORVIETO B0
Крючок ORVIETO B0

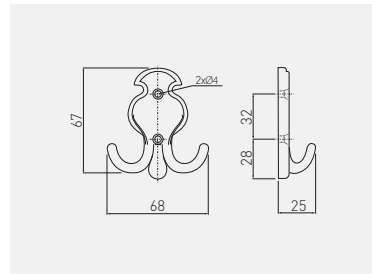

WZ-ORVIE-B0-09

antyczny mosiądz szczotkowany
antique brushed brass
античная шлифованная латунь

ZnAl

Wieszak K24
Hook K24
Крючок K24

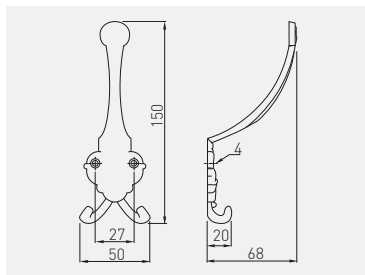

WZ-00-K24-04

antyczny mosiądz / antique brass / античная латунь

ZnAl



Wieszaki KID
Hook KID
Крючок KID



BLOCK



CLOUD



STAR



unicorn



ball

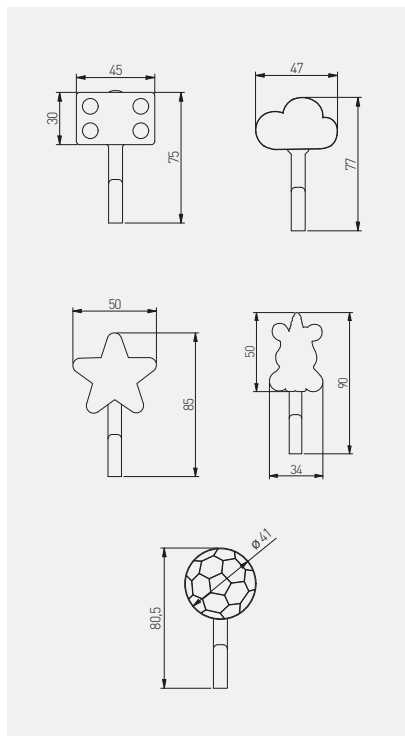

KID



	zielony green зеленый	niebieski blue синий	czerwony red красный	szary grey серый	żółty yellow желтый	czarno-biały black & white черно-белый	różowy pink розовый	
block	WM-BLOCK-ZL	WM-BLOCK-NB	WM-BLOCK-CZ	-	-	-	-	guma, ZnAl rubber, ZnAl резина, ZnAl
cloud	-	WM-CLOUD-NB	-	WM-CLOUD-SZ	-	-	-	
star	-	WM-STAR-NB	-	-	WM-STAR-ZT	-	WM-STAR-RZ	
unicorn	-	-	-	-	-	-	WM-UNICORN-RZ	
ball	-	-	-	-	-	WM-BALL-CZ-B	-	

Podpórka pod półkę BELT
Shelf support BELT
Полкодержатель BELT

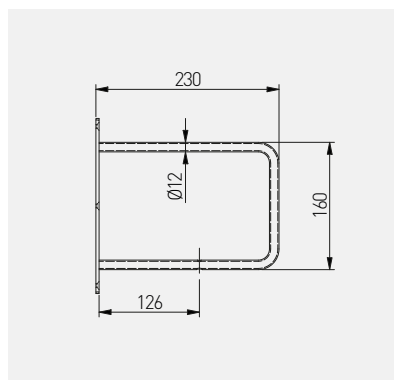

PP-BELT-20M



czarny / black / чёрный



stal / steel / сталь



30

Podpórka pod półkę FLAT
Shelf support FLAT
Полкодержатель FLAT

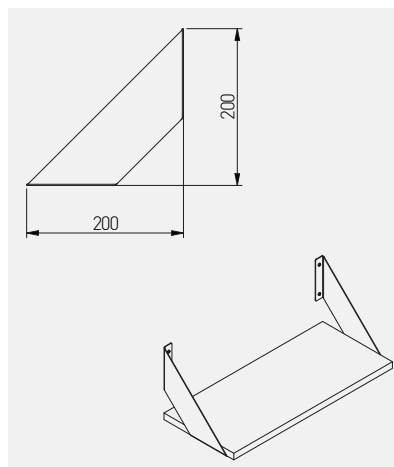

PP-FLAT-20M



czarny / black / чёрный



stal / steel / сталь



15



Podpórka pod półkę GALA
Shelf support GALA
Полкодержатель GALA

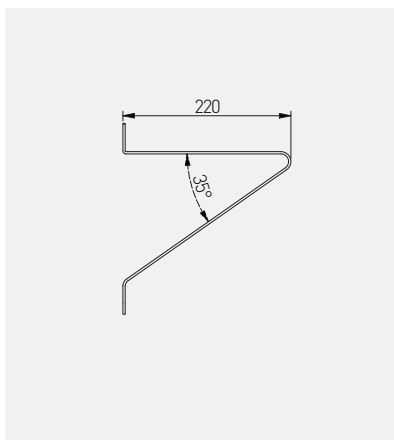

PP-GALA-20M	czarny / black / чёрный	stal / steel / сталь	30

Podpórka pod półkę GINO
Shelf support GINO
Полкодержатель GINO

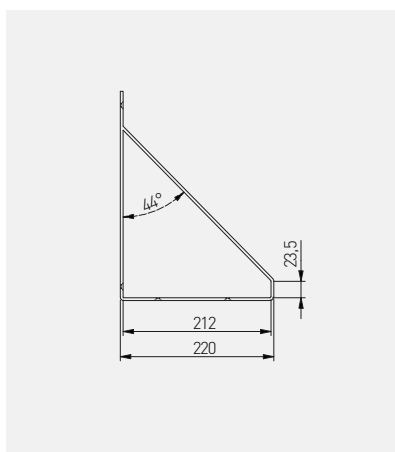

PP-GINO-20M	czarny / black / чёрный	stal / steel / сталь	30

GYPSY SET LIVING
AMERICAN FASHION



TIM WALKER STORY TELLER
ECO HOUSES
THE PLAYBOY BOOK
THE KINFOLK BOOK
Death & Co



FULLMOON
WAKE
DEVID CHIPPERFIELD



Podpórka pod półkę INGRID
Shelf support INGRID
Полкодержатель INGRID

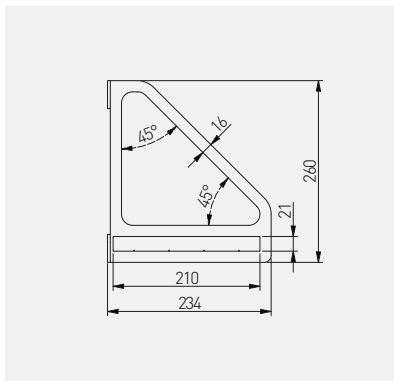

PP-INGRID-20M



czarny / black / чёрный



stal / steel / сталь



20

Podpórka pod półkę NEO
Shelf support NEO
Полкодержатель NEO

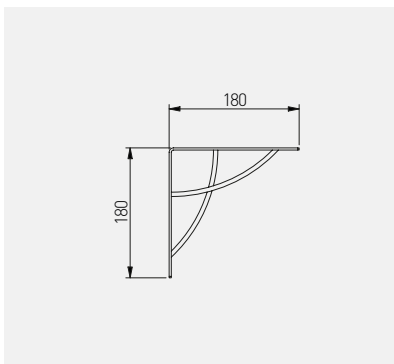

PP-NEO-20M



czarny / black / чёрный



stal / steel / сталь



20



Podpórka pod półkę BAR
Shelf support BAR
Полкодержатель BAR

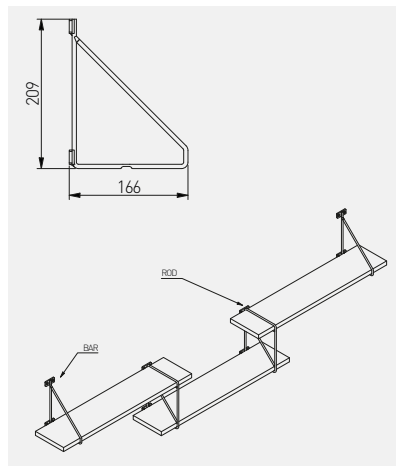

			
PP-BAR-20M	czarny / black / чёрный	stal / steel / сталь	20

Podpórka pod półkę ROD
Shelf support ROD
Полкодержатель ROD

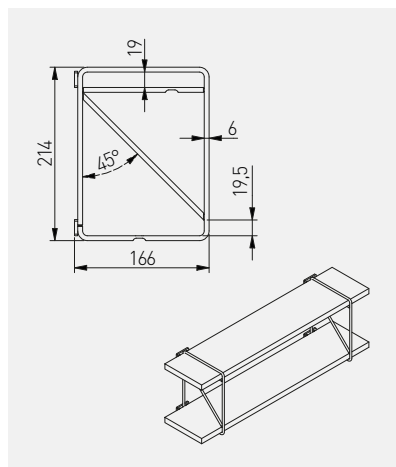

			
PP-ROD-20M	czarny / black / чёрный	stal / steel / сталь	20

Podpórka pod półkę TREE
Shelf support TREE
Полкодержатель TREE

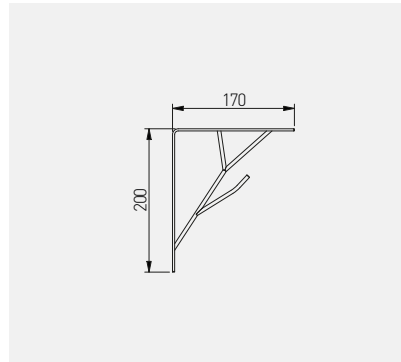

PP-TREE-20M	czarny / black / чёрный	stal / steel / сталь	20



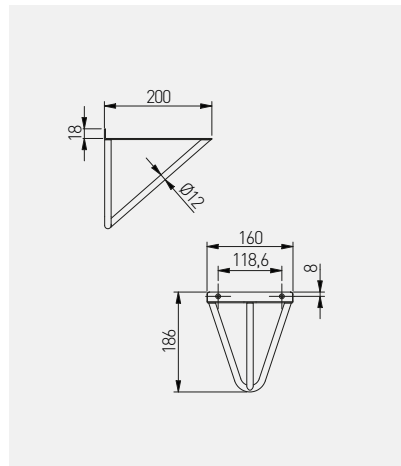

Podpórka pod półkę WIRE
Shelf support WIRE
Полкодержатель WIRE

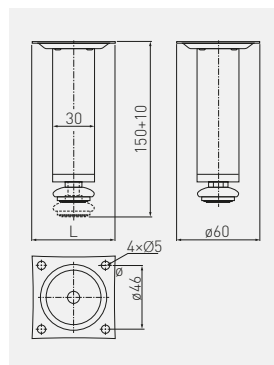

PP-WIRE-20M	czarny / black / чёрный	stal / steel / сталь	30





Nóżka BD-150 z regulacją
Adjustable leg BD-150
Ножка BD-150 с регулировкой

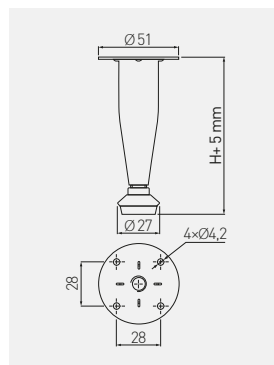

				
NM-BD-150-01	150 + 10	chrom / chrome / хром	stal / steel / сталь	80
NM-BD-150-02		satyna / satin / сатин		



Nóżka BD-03 z regulacją
Adjustable leg BD-03
Ножка BD-03 с регулировкой



				
NM-BD-003-01	100 + 5	chrom / chrome / хром	stal / steel / сталь	100
NM-BD-003-02		satyna / satin / сатин		

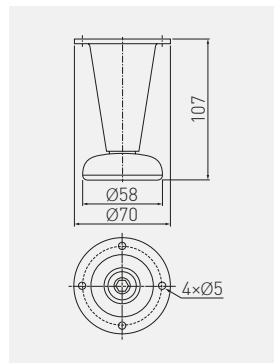



Nóżka BD-780
Leg BD-780
Ножка BD-780

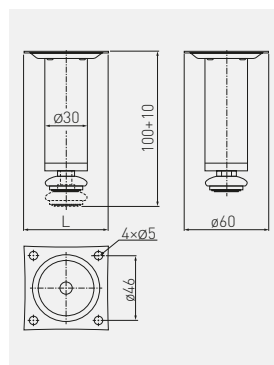

	 H mm			
NM-BD-780-M1	107	chrom / chrome / хром	stal / steel / сталь	50
NM-BD-780-M2		satyna / satin / сатин		
NM-BD-780-M5		aluminium / aluminium / алюминий		





Nóżka BD-100 z regulacją
Adjustable leg BD-100
Ножка BD-100 с регулировкой

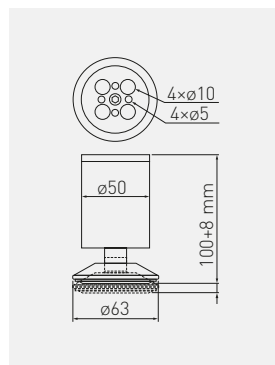

	 H mm			
NM-BD-100-01	100 + 10	chrom / chrome / хром	stal steel сталь	100
NM-BD-100-02		satyna / satin / сатин		
NM-BD-100-05		aluminium / aluminium / алюминий		
NM-BD-100-06		stal szcztokowana / brushed steel / шлифованная сталь		

Nóżka BD-762 z regulacją
Adjustable leg BD-762
Ножка BD-762 с регулировкой



	 H mm			
NM-BD-762-01	100 + 8	chrom / chrome / хром	ZnAl, stal ZnAl, steel	50
NM-BD-762-05		aluminium / aluminium / алюминий	ZnAl, сталь	

Nóżka BD-867
Leg BD-867
Ножка BD-867

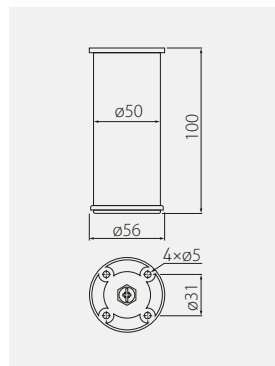

	 H mm			
NM-BD867-100	100	aluminium / aluminium / алюминий	aluminium / aluminium / алюминий	50

Nóżka BD-868
Leg BD-868
Ножка BD-868

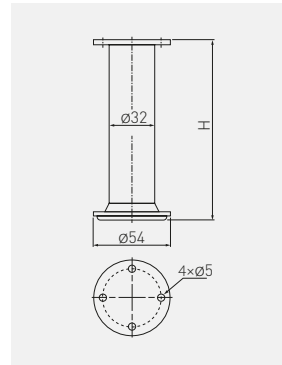

NM-BD868-100	100	aluminium / aluminium / алюминий	aluminium / aluminium / алюминий	50
NM-BD868-150	150			



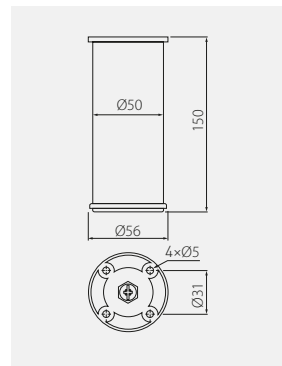

Nóżka BD-869
Leg BD-869
Ножка BD-869

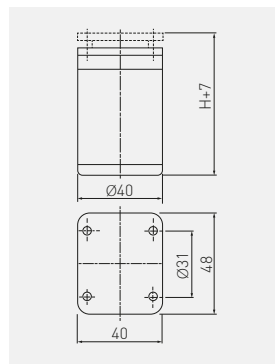

NM-BD869-150	150	aluminium / aluminium / алюминий	aluminium / aluminium / алюминий	50
--------------	-----	----------------------------------	----------------------------------	----





Nóżka DAP-77 z regulacją
Adjustable leg DAP-77
Ножка DAP-77 с регулировкой высоты

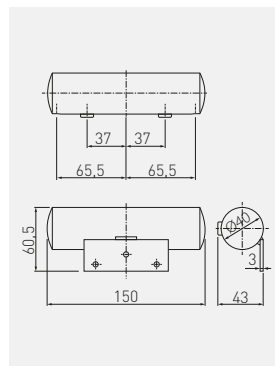

	 mm			
NM-DAP77-60	60 + 7	aluminium / aluminium / алюминий	aluminium, tworzywo aluminium, plastic алюминий, пластмасса	100
NM-DAP77-100	100 + 7			
NM-DAP77-150	150 + 7			





Nóżka BAHIA
Leg BAHIA
Ножка BAHIA

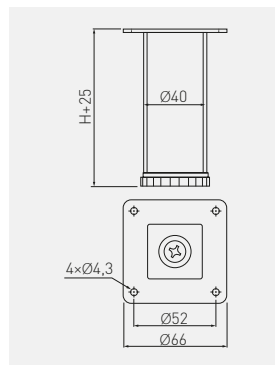

	 mm			
NM-BAHIA40-150-01	43	chrom / chrome / хром	stal, tworzywo steel, plastic сталь, пластмасса	50





Nóżka SQ-40 z regulacją
Adjustable leg SQ-40
Ножка SQ-40 с регулировкой высоты

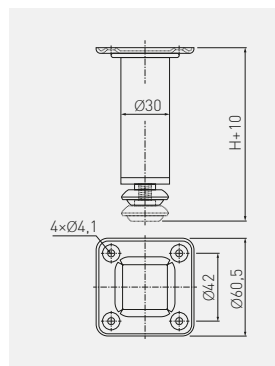

		 H mm			
NM-SQ40ADJ-060		60 + 25	chrom / chrome / хром	stal / steel / сталь	100
NM-SQ40ADJ-100		100 + 25	chrom / chrome / хром		50

Nóżka SQA z regulacją
Adjustable leg SQA
Ножка SQA с регулировкой высоты



		 H mm			
NM-SQA100-01		100 + 10	chrom / chrome / хром	stal / steel / сталь	100
NM-SQA150-01*		150 + 10			

* Dostępny na zamówienie / Available only for individual order / Доступен под заказ

Nóżka BD-727
Leg BD-727
Ножка BD-727

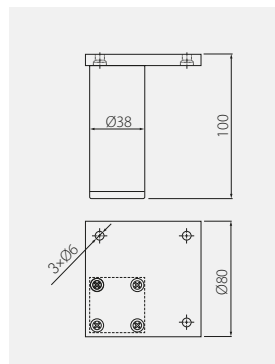

NM-BD727-100	100	aluminium / aluminium / алюминий	aluminium / aluminium / алюминий	50
--------------	-----	----------------------------------	----------------------------------	----



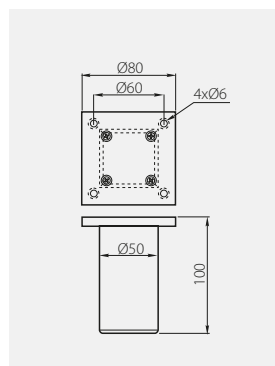

Nóżka BD-739
Leg BD-739
Ножка BD-739

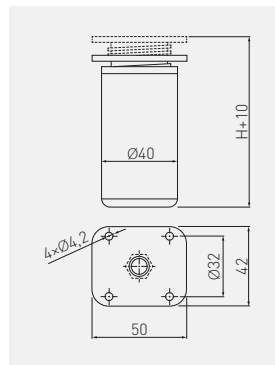

NM-BD-739-05	100	aluminium / aluminium / алюминий	aluminium / aluminium / алюминий	50
--------------	-----	----------------------------------	----------------------------------	----

Nóżka DAK-27 z regulacją
Adjustable leg DAK-27
Ножка DAK-27 с регулировкой высоты



		 H mm			
NM-DAK27-060		60 + 10	aluminium aluminium алюминий	aluminium, tworzywo aluminium, plastic алюминий, пластмасса	100
NM-DAK27-080		80 + 10			
NM-DAK27-100		100 + 10			
NM-DAK27-120		120 + 10			
NM-DAK27-150		150 + 10			

Nóżka NACK z regulacją
Adjustable leg NACK
Ножка NACK с регулировкой высоты

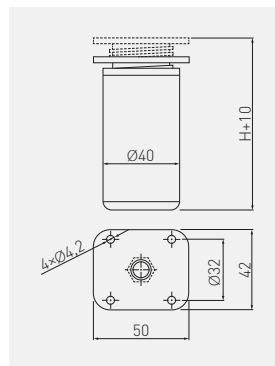

		 H mm			
NM-NACK27651-06		60 + 10	chrom chrome хром	tworzywo, aluminium plastic, aluminium пластмасса, алюминий	100

Nóżka BD-01
Leg BD-01
Ножка BD-01

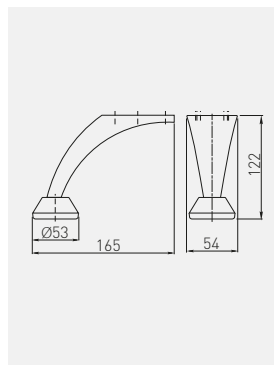

	 mm			
NM-BD-001-M1B	122	chrom / chrome / хром	stal / steel / сталь	80

Nóżka BD-712
Leg BD-712
Ножка BD-712

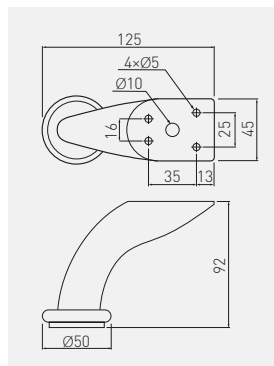



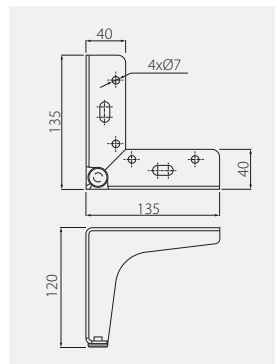

	 mm			
NM-BD-712-M1	92	chrom / chrome / хром	stal / steel / сталь	50

* Dostępny na zamówienie / Available only for individual order / Доступен под заказ

Nóżka STGY 135
Leg STGY 135
Ножка STGY 135



	 H mm			
NM-STGY135-100-01	100	chrom / chrome / хром	stal, tworzywo steel, plastic сталь, пластик	50
NM-STGY135-130-01*	130			
NM-STGY135-150-01*	150			

*Dostępny na zamówienie / Available only for individual order / Доступен под заказ



Nóżka STOMP
Leg STOMP
Ножка STOMP

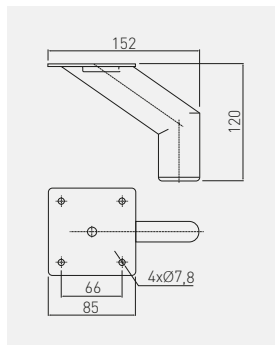

NM-STOMP-100-01*	100	chrom / chrome / хром	stal steel сталь	60
NM-STOMP-120-10*	120	biały / white / белый		
NM-STOMP-120-20		czarny / black / чёрный		
NM-STOMP-130-01*	130	chrom / chrome / хром	stal steel сталь	60
NM-STOMP-130-06*		stal szorstkowana / brushed steel / шлифованная сталь		
NM-STOMP-130-20*		czarny / black / чёрный		
NM-STOMP-150-01*	150	chrom / chrome / хром		
NM-STOMP-160-01*	160	chrom / chrome / хром	stal steel сталь	60
NM-STOMP-160-06*		stal szorstkowana / brushed steel / шлифованная сталь		
NM-STOMP-160-20*		czarny / black / чёрный		

*Dostępny na zamówienie / Available only for individual order / Доступен под заказ

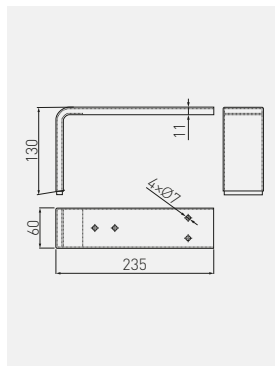

Nóżka MDN-D4
Leg MDN-D4
Ножка MDN-D4



NM-MDN-D4-01	130	chrom / chrome / хром	stal / steel / сталь	25
--------------	-----	-----------------------	----------------------	----

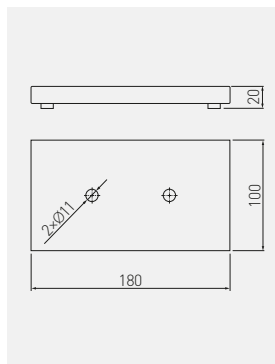

Nóżka MDN-926
Leg MDN-926
Ножка MDN-926

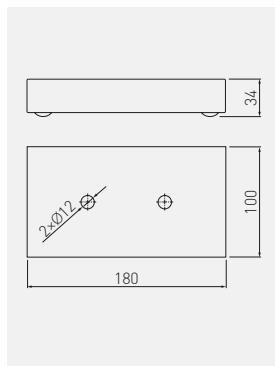

	 H mm			
NM-MDN926-01	20	chrom / chrome / хром	stal / steel / сталь	50

Nóżka MDN-927
Leg MDN-927
Ножка MDN-927



	 H mm			
NM-MDN927-01	34	chrom / chrome / хром	stal / steel / сталь	50

Nóżka MDN-941
Leg MDN-941
Ножка MDN-941

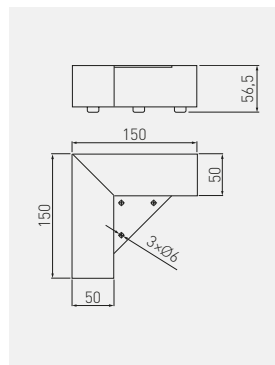

NM-MDN941-01



56



chrom / chrome / хром



stal / steel / сталь



25

Ślizgacz WPJ z regulacją
Adjustable furniture slider WPJ
Опора WPJ с регулировкой

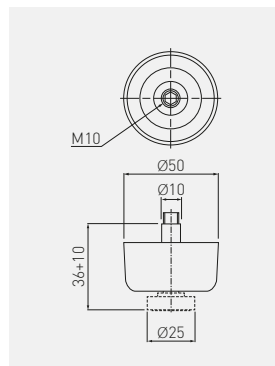

NM-WPJ22-D20



36 + 10



czarny / black / чёрный



tworzywo / plastic / пластмасса



5

Ślizgacz SLZ pojedynczy
Furniture slider SLZ single
Опора SLZ одинарная

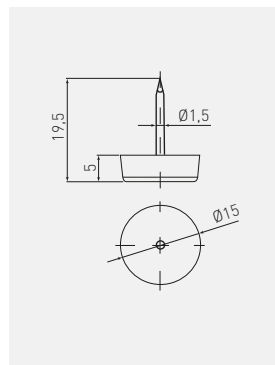

BP-SLZIGW-10

czarny / black / чёрный

tworzywo / plastic / пластмасса

Ślizgacz SLZ podwójny
Furniture slider SLZ double
Опора SLZ двойная

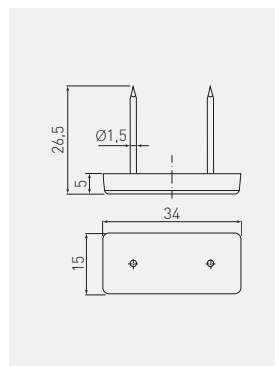

BP-SLZIGW-21

czarny
black
чёрный

tworzywo
plastic
пластмасса

250

Stopka M6 regulowana
Foot M6 adjustable
Ножка M6 с регулировкой

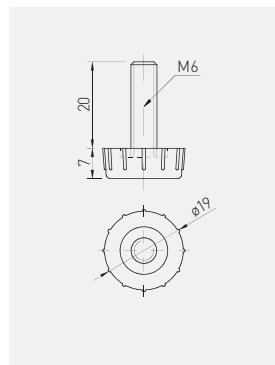

NM-STOPKA-M6



ocynk
galvanized
гальваника



stal, tworzywo
steel, plastic
сталь, пластмасса

Stopka M6 regulowana sześciokątna
Foot M6 adjustable hexagonal
Ножка M6 с регулировкой (шестигранная)

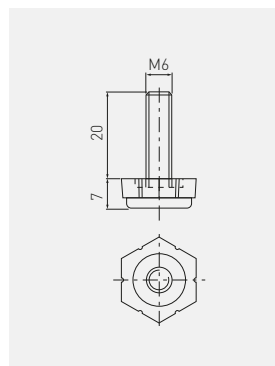

NM-STOPKSZESTK-M6



ocynk
galvanized
гальваника



stal, tworzywo
steel, plastic
сталь, пластмасса



250

Mufa M6
Socket M6
Муфта M6



NM-MUFAWB-00



NM-MUFAWK-00

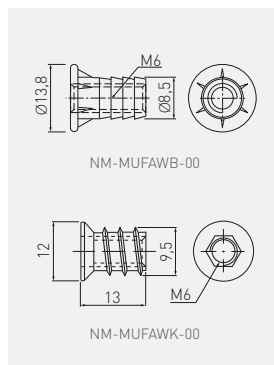

NM-MUFAWB-00	wbijana screw-in sleeve врезная	srebrny silver серебряный	ZnAl	2500
NM-MUFAWK-00	wkręcana screwed для вкручивания			4000

Nóżka DPD z regulacją
Adjustable leg DPD
Ножка DPD с регулировкой

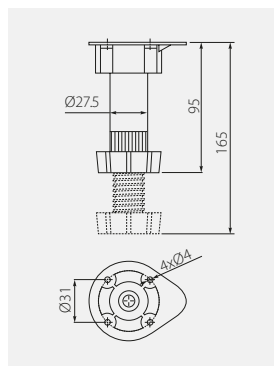

NM-DPD20-100	95 – 165 mm	60 kg	czarny / black / чёрный	tworzywo / plastic / пластмасса	200

Klip do nóżki DPD
Plinth clip DPD
Клипса к ножке DPD

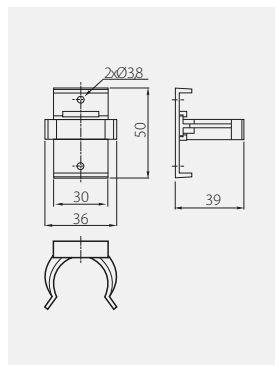

NM-KL-DPL-20



czarny / black / чёрный



tworzywo / plastic / пластмасса



1500

Nóżka DPA
Leg DPA
Ножка DPA

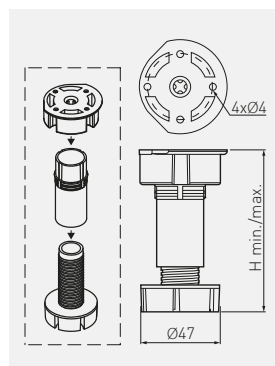

NM-DPA20-100

pakowane w karton
packing in box
картонная упаковка

87 - 120



mm



kg

100



czarny
black
чёрный



tworzywo
plastic
пластмасса



250

NM-DPA20-150

картонная упаковка

137 - 170

NM-DPA20-100W

pakowane w worek
packing in plastic bag
полиэтиленовый пакет

87 - 120

NM-DPA20-150W

полиэтиленовый пакет

137 - 170

200

100

400

Klip do nóżki DPA
Plinth clip DPA
Клипса к ножке DPA

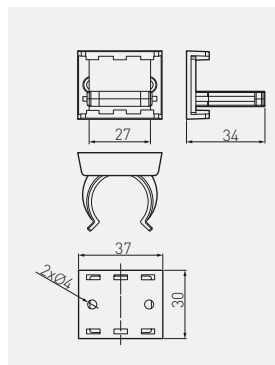

NM-KL-DPA-20



czarny / black / чёрный



tworzywo / plastic / пластмасса

Nóżka MLA-50 z regulacją
Adjustable leg MLA-50
Ножка MLA-50 с регулировкой

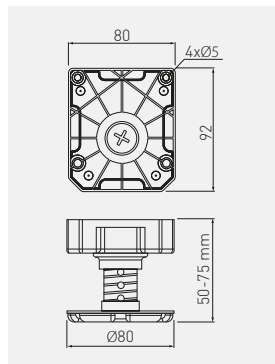

NM-MLA-50-75



50-75



450



czarny / black / чёрный







tworzywo / plastic / пластмасса

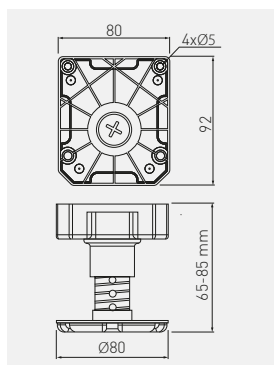

50







Nóżka MLA-65 z regulacją
Adjustable leg MLA-65
Ножка MLA-65 с регулировкой

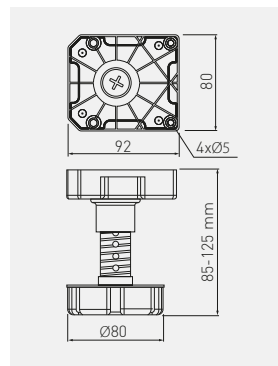

	 H mm	 kg			
NM-MLA-65-85	65 – 85	450	czarny / black / чёрный	tworzywo / plastic / пластмасса	50







Nóżka MLA-85 z regulacją
Adjustable leg MLA-85
Ножка MLA-85 с регулировкой

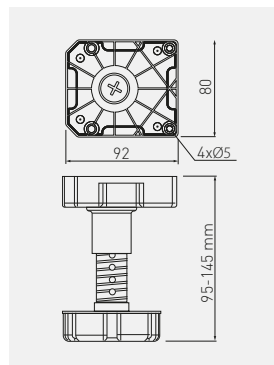

	 H mm	 kg			
NM-MLA-85-125	85 – 125	450	czarny / black / чёрный	tworzywo / plastic / пластмасса	50

Nóżka MLA-95 z regulacją
Adjustable leg MLA-95
Ножка MLA-95 с регулировкой



	 H mm	 kg t			
NM-MLA-95-145	95 – 145	450	czarny / black / чёрный	tworzywo / plastic / пластмасса	100

Nóżka MLA-125 z regulacją
Adjustable leg MLA-125
Ножка MLA-125 с регулировкой

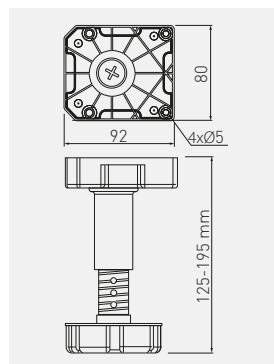

	 H mm	 kg t			
NM-MLA-125-195	125 – 195	450	czarny / black / чёрный	tworzywo / plastic / пластмасса	50

Klip do nóżek MLA
 Clip for MLA legs
 Клипса к ножке MLA

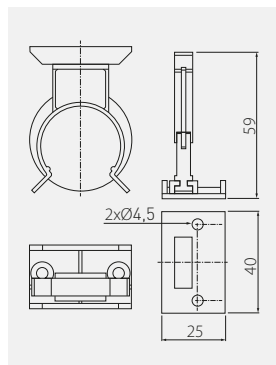

NM-MLA-KL



czarny / black / чёрный



tworzywo / plastic / пластмасса



100



Noga A6 z regulacją
Adjustable leg A6
Опора A6 с регулировкой

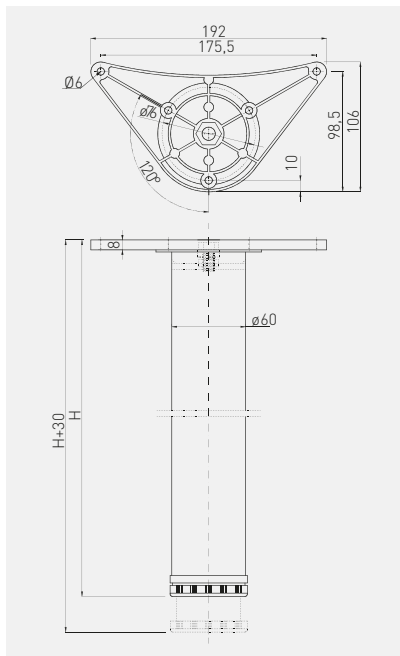



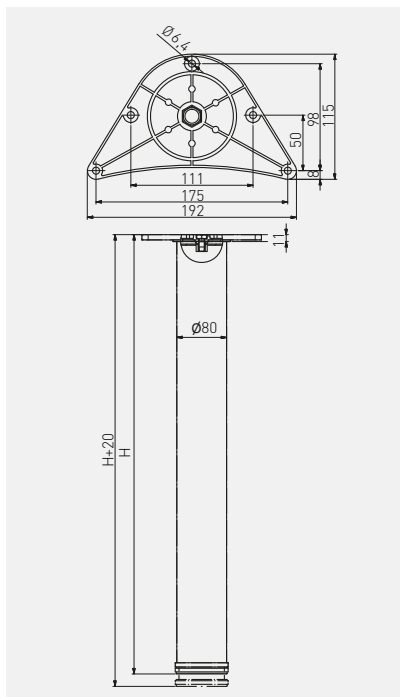

NM-A60710-01	710 + 30	chrom / chrome / хром	ZnAl, stal ZnAl, steel ZnAl, сталь	4
NM-A60710-02		satyna / satin / сатин		
NM-A60710-05		aluminium / aluminium / алюминий		
NM-A60710-06*		stal szczotkowana / brushed steel / шлифованная сталь		
NM-A60710-10N*		biały / white / белый		
NM-A60710-20		czarny / black / чёрный		
NM-A60710-80N	srebrny / silver / серебристый			
NM-A60820-01	820 + 30	chrom / chrome / хром		
NM-A60820-02		satyna / satin / сатин		
NM-A60820-05		aluminium / aluminium / алюминий		
NM-A60820-06*		stal szczotkowana / brushed steel / шлифованная сталь		
NM-A60820-10N*		biały / white / белый		
NM-A60820-20*		czarny / black / чёрный		
NM-A60820-80N*	srebrny / silver / серебристый			
NM-A60870-01*	1100 + 30	chrom / chrome / хром		
NM-A60870-02*		satyna / satin / сатин		
NM-A60870-05*		aluminium / aluminium / алюминий		
NM-A60870-06*		stal szczotkowana / brushed steel / шлифованная сталь		
NM-A60870-10N*		biały / white / белый		
NM-A60870-20*		czarny / black / чёрный		
NM-A60870-80N*	srebrny / silver / серебристый			
NM-A61100-01	1100 + 30	chrom / chrome / хром		
NM-A61100-02		satyna / satin / сатин		
NM-A61100-05		aluminium / aluminium / алюминий		
NM-A61100-06		stal szczotkowana / brushed steel / шлифованная сталь		
NM-A61100-10N*		biały / white / белый		
NM-A61100-20*		czarny / black / чёрный		

* Dostępny na zamówienie / Available only for individual order / Доступен под заказ

Noga NM-A80 z regulacją
Adjustable leg NM-A80
Опора NM-A80 с регулировкой



		 H mm			
NM-A80710-01*	710 + 20		chrom / chrome / хром	ZnAl, stal ZnAl, steel ZnAl, сталь	2
NM-A80710-02*			satyna / satin / сатин		
NM-A80710-03*			złoty / gold / золото		
NM-A80710-05*			aluminium / aluminium / алюминий		
NM-A80710-06*			stal szczotkowana / brushed steel / шлифованная сталь		
NM-A80710-10*			biały / white / белый		
NM-A80710-20*			czarny / black / чёрный		
NM-A80710-80*			srebrny / silver / серебристый		
NM-A80870-01*	870 + 20		chrom / chrome / хром		
NM-A80870-02*			satyna / satin / сатин		
NM-A80870-03*			złoty / gold / золото		
NM-A80870-05*			aluminium / aluminium / алюминий		
NM-A80870-06*			stal szczotkowana / brushed steel / шлифованная сталь		
NM-A80870-10*			biały / white / белый		
NM-A80870-20*			czarny / black / чёрный		
NM-A80870-80*			srebrny / silver / серебристый		

* Dostępny na zamówienie / Available only for individual order / Доступен под заказ

Noga G6 z regulacją
Adjustable leg G6
Опора G6 с регулировкой

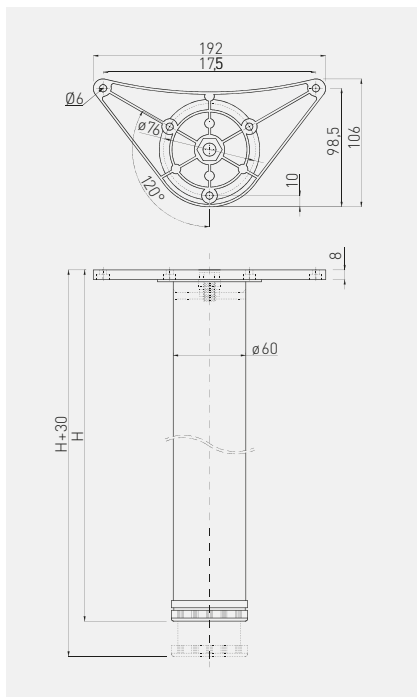



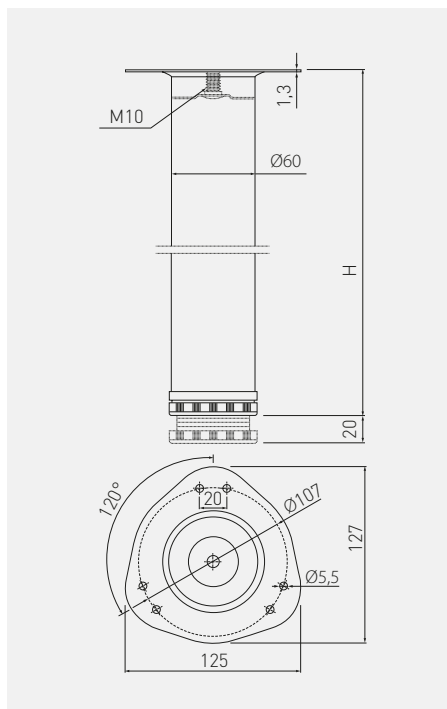

		 H mm			
NM-G60710-01N	710 + 30		chrom / chrome / хром	ZnAl, stal ZnAl, steel ZnAl, сталь	4
NM-G60710-02N			satyna / satin / сатин		
NM-G60710-05N			aluminium / aluminium / алюминий		
NM-G60710-06N			stal szorstkowana / brushed steel / шлифованная сталь		
NM-G60710-10N*			biały / white / белый		
NM-G60710-20N			czarny / black / чёрный		
NM-G60710-80N			srebrny / silver / серебристый		
NM-G60820-01N	820 + 30		chrom / chrome / хром		
NM-G60820-05N			aluminium / aluminium / алюминий		
NM-G60820-06N			stal szorstkowana / brushed steel / шлифованная сталь		
NM-G60820-10N*			biały / white / белый		
NM-G60820-20N			czarny / black / чёрный		
NM-G61100-01N	1100 + 30		chrom / chrome / хром		
NM-G61100-20N			czarny / black / чёрный		

* Na zamówienie dostępna w kolorze białym / For special orders available in white color / Под заказ доступна в белом цвете

Noga S6 z regulacją
Adjustable leg S6
Опора S6 с регулировкой



		 H mm			
NM-S60710-01A		710 + 20	chrom / chrome / хром	steel steel stаль	4
NM-S60710-02A			satyna / satin / сатин		
NM-S60710-05A			aluminium / aluminium / алюминий		
NM-S60710-06A			stal szcztokowana / brushed steel / шлифованная сталь		
NM-S60710-10A*			biały / white / белый		
NM-S60710-20A			czarny / black / чёрный		
NM-S60820-01A		820 + 20	chrom / chrome / хром		
NM-S60820-02A*			satyna / satin / сатин		
NM-S60820-05A			aluminium / aluminium / алюминий		
NM-S60820-06A*			stal szcztokowana / brushed steel / шлифованная сталь		
NM-S60820-10A*			biały / white / белый		
NM-S60820-20A*			czarny / black / чёрный		

* Dostępny na zamówienie / Available only for individual order / Доступен под заказ

Noga F-50 składana
 Leg F-50 foldable
 Складная опора F-50

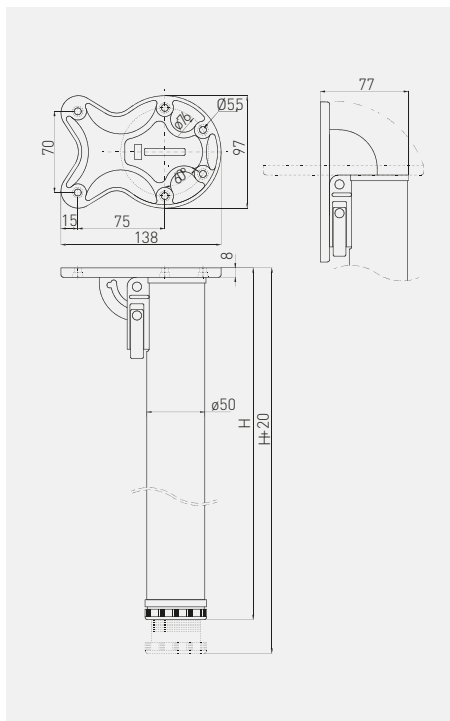



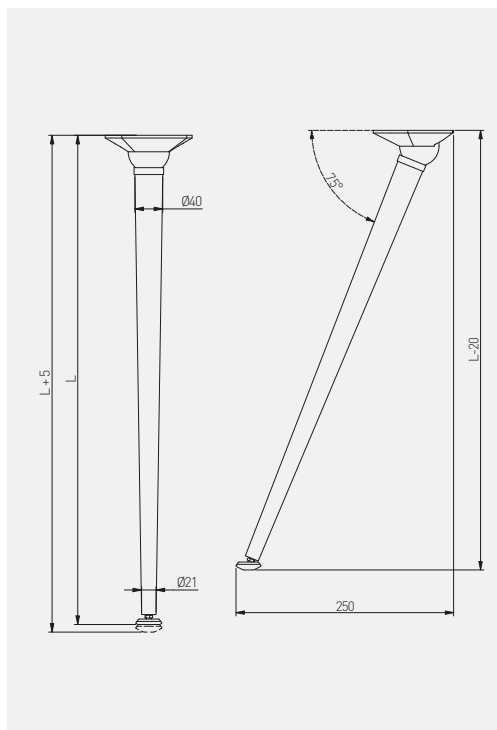

		 H mm					
NM-F50710-01		710 + 20	chrom / chrome / хром				
NM-F50710-06			stal szczotkowana / brushed steel / шлифованная сталь				
NM-F50710-10			biały / white / белый				
NM-F50710-20			czarny / black / чёрный				
NM-F50870-01		870 + 20	chrom / chrome / хром			ZnAl, stal, ABS ZnAl, steel, ABS ZnAl, сталь, ABS	8
NM-F50870-06			stal szczotkowana / brushed steel / шлифованная сталь				
NM-F50870-10*			biały / white / белый				
NM-F50870-20			czarny / black / чёрный				

* Dostępny na zamówienie / Available only for individual order / Доступен под заказ

Noga X-LINE skośna
X-LINE oblique leg
X-LINE косяя нога







		 mm			
NM-X-LINE40710-01		710	chrom / chrome / хром	stal, tworzywo steel, plastic сталь, пластмасса	4
NM-X-LINE40710-20			czarny / black / чёрный		
NM-X-LINE40710-10			biały / white / белый		

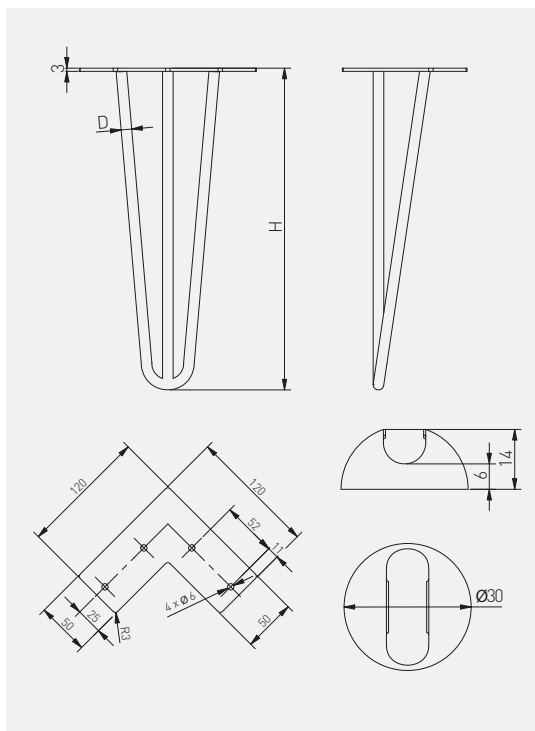

Noga ARTO – HAIRPIN
 ARTO leg – HAIRPIN
 ARTO нога – HAIRPIN







	 H mm	\varnothing D (mm)			
NM-ARTO-10-3R304-20M	304	ø10	czarny mat black matt чёрный матовый	stal, tworzywo steel, plastic сталь, пластмасса	4
NM-ARTO-10-3R406-20M	406				
NM-ARTO-10-3R711-20M	711				
NM-ARTO-12-3R304-20M	304	ø12			
NM-ARTO-12-3R406-20M	406				
NM-ARTO-12-3R711-20M	711				

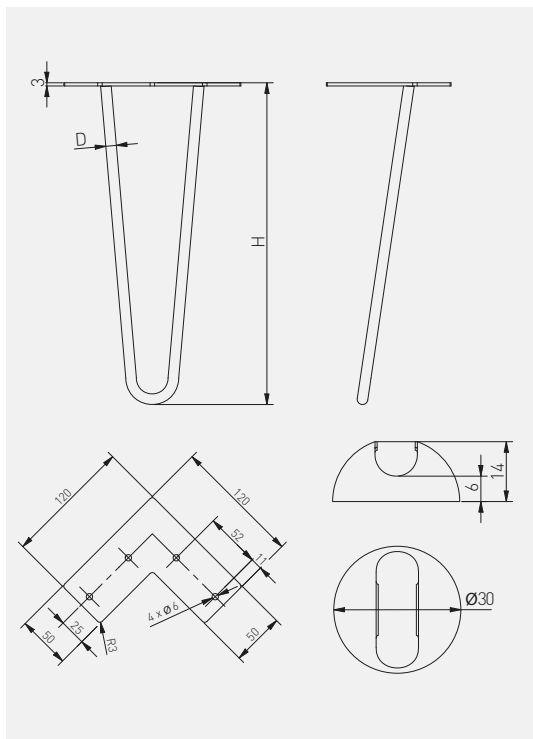



Noga ARTO – HAIRPIN
 ARTO leg – HAIRPIN
 ARTO нога – HAIRPIN

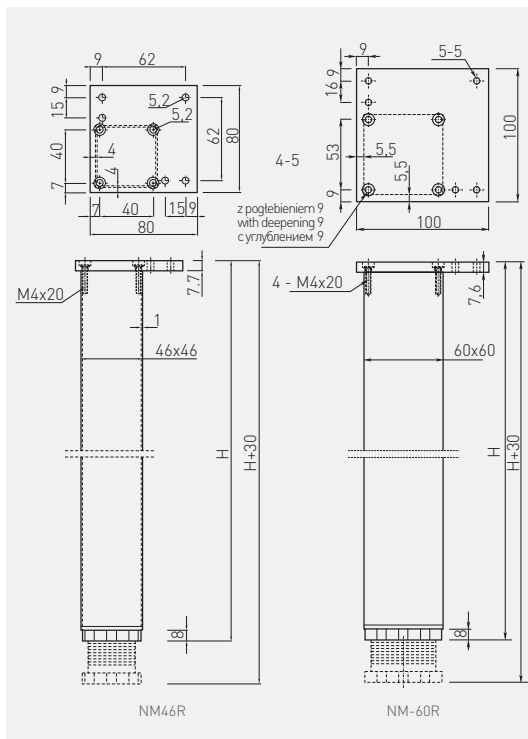
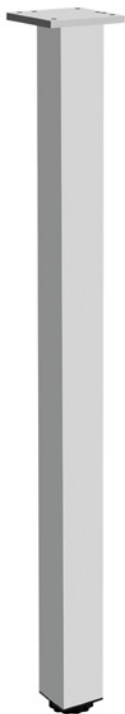

	 H mm	\varnothing D (mm)			
NM-ARTO-10-2R304-20M	304	Ø10	czarny mat black matt чёрный матовый	stal, tworzywo steel, plastic сталь, пластмасса	4
NM-ARTO-10-2R406-20M	406				
NM-ARTO-10-2R711-20M	711				
NM-ARTO-12-2R304-20M	304	Ø12			
NM-ARTO-12-2R406-20M	406				
NM-ARTO-12-2R711-20M	711				

Noga kwadratowa z regulacją
 Square furniture leg
 Мебельная опора с регулировкой



	 H mm		 	
NM-46R710-05	710 + 30	aluminium / aluminium / алюминий		4
NM-46R820-05	820 + 30			
NM-60R710-05	710 + 30			
NM-60R820-05	820 + 30			
NM-60R710-06	710 + 30	stal szczerkowana / brushed steel / шлифованная сталь		
NM-60R710-20		czarny / black / чёрный		

Noga stelażowa INDUSTRIA
 Industria frame
 Опора для столешницы Industria



NEW

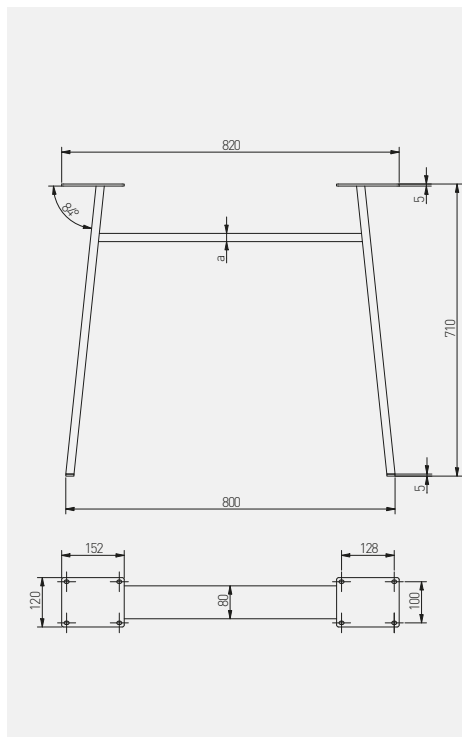

			a (mm)		
NM-INDUSTRIA-H20-710X820-20M*	czarny mat / black matt / чёрный матовый		20	stal steel сталь	1
NM-INDUSTRIA-H40-710X820-20M*			40		

*Dostępny na zamówienie indywidualne / Available only for individual order / Доступен под заказ





Noga stelażowa INDUSTRIA
 Industria frame
 Опора для столешницы Industria

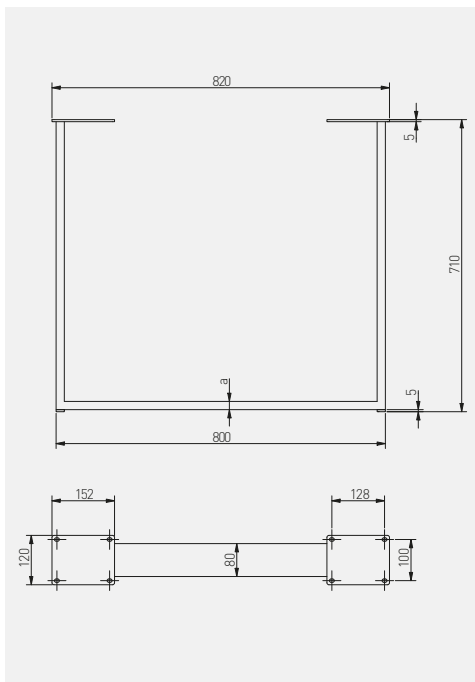

NEW



		a (mm)		
NM-INDUSTRIA-P20-710X820-20M*	czarny mat / black matt / чёрный матовый	20	stal steel сталь	1
NM-INDUSTRIA-P40-710X820-20M*		40		
NM-INDUSTRIA-P80-710X820-20M*		80		

*Dostępny na zamówienie indywidualne / Available only for individual order / Доступен под заказ

Noga stelażowa INDUSTRIA
 Industria frame
 Опора для столешницы Industria

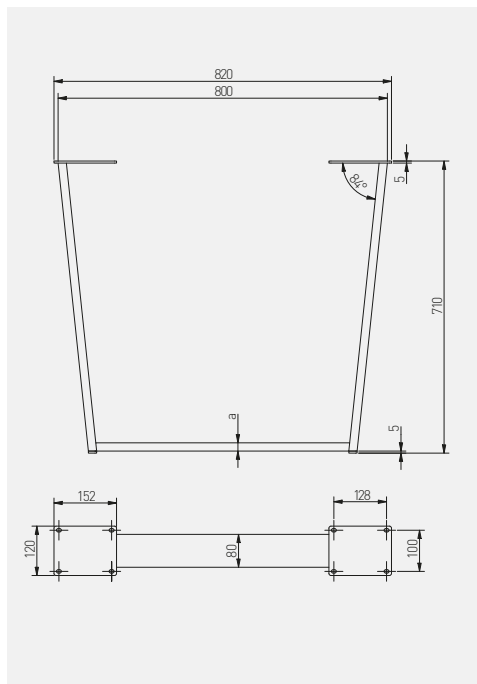

		a (mm)		
NM-INDUSTRIA-T20-710X820-20M*	czarny mat / black matt / чёрный матовый	20	stal steel сталь	1
NM-INDUSTRIA-T40-710X820-20M*		40		

*Dostępny na zamówienie indywidualne / Available only for individual order / Доступен под заказ

Noga stelażowa INDUSTRIA
 Industria frame
 Опора для столешницы Industria



NEW

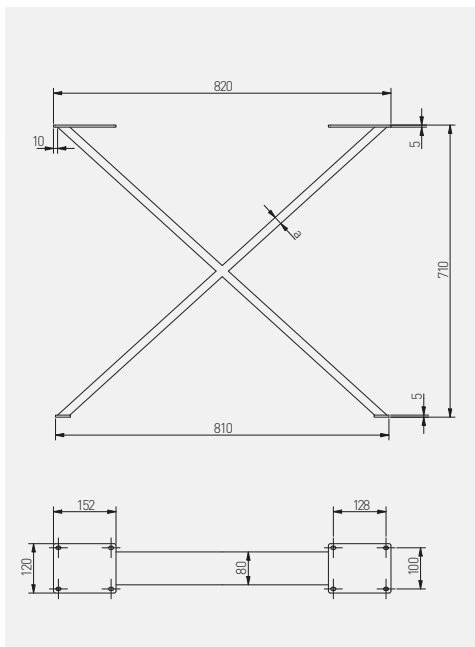

			a (mm)		
NM-INDUSTRIA-X20-710X820-20M*			20		
NM-INDUSTRIA-X40-710X820-20M*		czarny mat / black matt / чёрный матовый	40	stal steel сталь	1
NM-INDUSTRIA-X80-710X820-20M*			80		

*Dostępny na zamówienie indywidualne / Available only for individual order / Доступен под заказ

Stelaż biurkowy
 Metal frames for desk
 Металлический каркас для стола

NEW

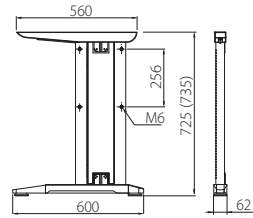

Otwory do montażu blatu Ø7
 Table top mounting holes Ø7
 Отверстия для монтажа столешницы Ø7







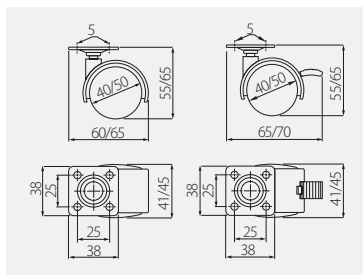

SB-A60X72-80	725 (735) mm	srebrny / silver / серебристый	stal / steel / сталь	1
SB-A60x72-20M		czarny mat / black matt / чёрный матовый		1









Rolka KM-D20
 Furniture caster KM-D20
 Колёсики KM-D20

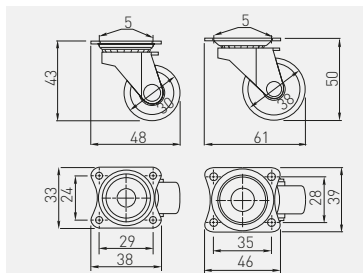

		 mm	 kg		
KM-00-40-D20	bez hamulca without break без стопора	40	18	czarny black чёрный	stal + tworzywo steel + plastic сталь + пластмасса
KM-00-50-D20		50	22		
KM-0H-40-D20	z hamulcem with break со стопором	40	18		
KM-0H-50-D20		50	22		

Rolka KM 15 plastikowa
 Furniture caster KM 15 plastic
 Пластиковые колёсики KM 15



	 mm	 kg		
KM-015030-10	30	13,5	biały / white / белый	stal + tworzywo steel + plastic сталь + пластмасса
KM-015030-20			czarny / black / чёрный	
KM-015038-10	38	16	biały / white / белый	



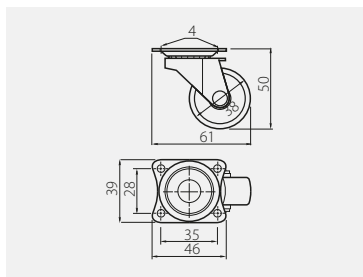



Rolka KM 15 gumowa
 Rubber furniture caster KM 15
 Резиновые колёсики KM 15

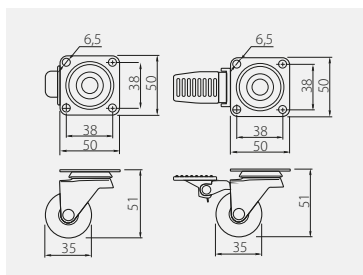

	 mm	 kg		
KM-015038-GM	38	16	czarny / black / чёрный	stal + guma steel + rubber сталь + резина

Rolka KMA 35
 Furniture caster KMA 35
 Колёсики KMA 35



		 mm	 kg		
KM-A035MM-00	bez hamulca without break	35	25	przeźroczysty / transparent / прозрачный	PC / PU
KM-A035MM-30	bez stopora без стопора			brązowy / brown / коричневый	
KM-AH35MM-00	z hamulcem with break			przeźroczysty / transparent / прозрачный	
KM-AH35MM-30	co stoporem со стопором			brązowy / brown / коричневый	

Rolka KMA 50
Furniture caster KMA 50
Колёсики KMA 50

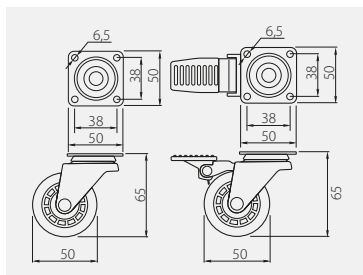

KM-A050MM-00	bez hamulca without break без стопора	50	35	przeźroczysty / transparent / прозрачный	PC / PU
KM-A050MM-30	brąz / brown / коричневый				
KM-AH50MM-00	z hamulcem with break со стопором	przeźroczysty / transparent / прозрачный			
KM-AH50MM-30	brąz / brown / коричневый				



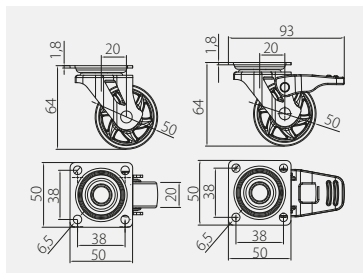

Rolka SHIFT 50
Furniture caster SHIFT 50
Колёсики SHIFT 50

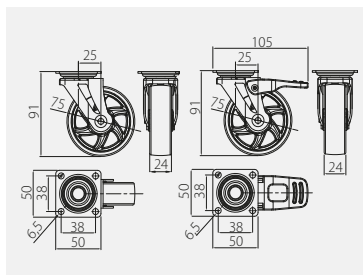

KM-B050MM-00	bez hamulca without break без стопора	50	30	przeźroczysty / transparent / прозрачный	PC / PU
KM-B050MM-30	brąz / brown / коричневый				
KM-BH50MM-00	z hamulcem with break со стопором	przeźroczysty / transparent / прозрачный			
KM-BH50MM-30	brąz / brown / коричневый				





Rolka SHIFT 75
 Furniture caster SHIFT 75
 Колёсики SHIFT 75

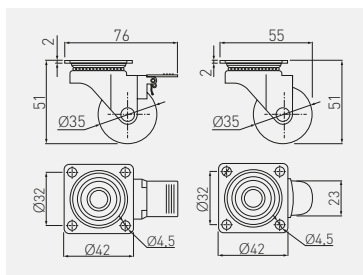

					
KM-B075MM-00	bez hamulca without break	75	40	przeźroczysty / transparent / прозрачный	PC / PU
KM-B075MM-30	bez stopora без стопора			brąz / brown / коричневый	
KM-BH75MM-00	z hamulcem with break			przeźroczysty / transparent / прозрачный	
KM-BH75MM-30	co stoporem со стопором			brąz / brown / коричневый	





Rolka BRAZYLIA 35
 Furniture caster BRAZYLIA 35
 Колёсики BRAZYLIA 35

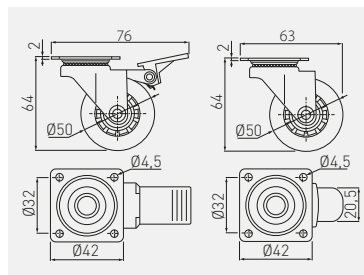

					
KM-RD-35-SF	bez hamulca without break	35	30	przeźroczysty / transparent / прозрачный	PC, PU
KM-RD-35-SF-20	bez stopora без стопора			czarny / black / чёрный	
KM-RD-35-CF	z hamulcem with break			przeźroczysty / transparent / прозрачный	
KM-RD-35-CF-20	co stoporem со стопором			czarny / black / чёрный	





Rolka BRAZYLIA 50
 Furniture caster BRAZYLIA 50
 Колёсики BRAZYLIA 50

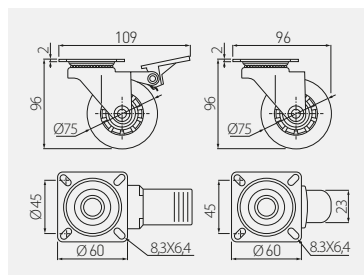

					
KM-RD-50-SF	bez hamulca without break	50	40	przeźroczysty / transparent / прозрачный	PC, PU
KM-RD-50-SF-20	bez stopora			czarny / black / чёрный	
KM-RD-50-CF	z hamulcem with break	50	40	przeźroczysty / transparent / прозрачный	
KM-RD-50-CF-20	so stoporem			czarny / black / чёрный	





Rolka BRAZYLIA 75
 Furniture caster BRAZYLIA 75
 Колёсики BRAZYLIA 75

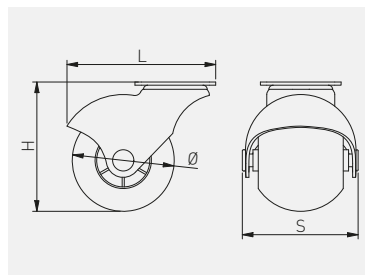

					
KM-RD-75-SF	bez hamulca without break	75	64	przeźroczysty / transparent / прозрачный	PC, PU
KM-RD-75-SF-20	bez stopora			czarny / black / чёрный	
KM-RD-75-CF	z hamulcem with break	75	64	przeźroczysty / transparent / прозрачный	
KM-RD-75-CF-20	so stoporem			czarny / black / чёрный	







Rolka SPAIN
 Furniture Castor SPAIN
 Мебельные ролики SPAIN

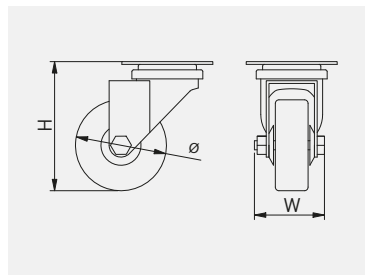

	 mm	 kg		
KM-SPAIN-40MM-18	40	15	szary, grey, серый	stal + guma steel + rubber сталь + резина
KM-SPAIN-50MM-18	50	20		

Rolka GREYROLL
 Castor GREYROLL
 Ролики GREYROLL



		 mm	 kg		
KM-GREYROLL-50mm-BH	bez hamulca without break без стопора	50	40	szary, grey, серый	stal + guma steel + rubber сталь + резина
KM-GREYROLL-75mm-BH		75	55		
KM-GREYROLL-50mm-ZH	z hamulcem with break со стопором	50	40		
KM-GREYROLL-75mm-ZH		75	55		

**SYSTEMY PRZESUWNE
SLIDING DOOR SYSTEMS
РАЗДВИЖНЫЕ СИСТЕМЫ**

Dolny układ jezdny
Bottom-running systems
Нижняя ходовая система

486 – 516

Górny układ jezdny
Top-running systems
Верхняя ходовая система

517 – 521





POZNAJ KONFIGURATOR SZAF I DRZWI PRZESUWNYCH GTV DISCOVER THE GTV CONFIGURATOR FOR WARDROBES AND SLIDING DOOR SYSTEM

ПОЗНАКОМЬТЕСЬ С КОНФИГУРАТОРОМ ШКАФОВ И РАЗДВИЖНЫХ ДВЕРЕЙ ОТ GTV

Jeśli chcesz, żeby Twoja codzienna praca przy projektowaniu szaf była łatwiejsza, mamy świetne rozwiązanie – konfigurator szaf i drzwi przesuwnych GTV. To łatwe i intuicyjne narzędzie, które usprawni i przyspieszy pracę każdego stolarza. Z konfiguratora mogą również korzystać hurtownie meblowe, firmy oraz fabryki zajmujące się produkcją szaf. Konfigurator szaf GTV pozwala na otrzymanie dokładnego podsumowania w pliku PDF z informacjami technicznymi o szafie. Ostateczny raport ułatwia dokonanie zakupów potrzebnych materiałów.

If you want to make your daily work on designing wardrobes easier, we have got a great solution for you – the configurator for wardrobes and sliding door system from GTV. It is very intuitive and easy to use tool, which improve and accelerate the work of every carpenter. Our configurator can be also used by furniture wholesalers, companies and factories that manufacture cabinets. The GTV configurator gives you a detailed summary in a PDF file with technical information about the cabinet. With the final report from configurator it will be easier to purchase material you need.





Если вы хотите, чтобы ваша ежедневная работа над дизайном шкафов стала проще, у нас есть отличное решение - конфигурактор шкафов и раздвижных дверей от GTV. Это простой и интуитивно понятный инструмент, который улучшит и ускорит работу каждого мебельщика. К помощи конфигуратора могут прибегнуть оптовые продавцы мебели, а также фабрики, производящие шкафы-купе. Конфигуратор шкафов GTV позволяет получить точный список в файле PDF с технической информацией о гардеробной. Окончательный отчет сделает покупку необходимых материалы очень легкой.



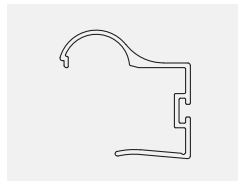

Rączka ERGO
Handle ERGO
Ручка ERGO



	 L mm		
A-R18ERG-270-05	2700	aluminium / aluminium / алюминий	aluminium aluminium алюминий
A-R18ERG-270-90		szampan / champagne / шампань	
A-R18ERG-270-20M		czarny mat / black matt / чёрный матовый	



Rączka ERGO 16
Handle ERGO 16
Ручка ERGO 16

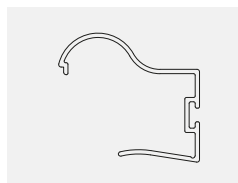

	 L mm		
A-R16ERG-220-05	2200	aluminium / aluminium / алюминий	aluminium aluminium алюминий
A-R16ERG-230-50	2300	aluminium / aluminium / алюминий	
A-R16ERG-270-50	2700	aluminium / aluminium / алюминий	
A-R16ERG-270-90	2700	szampan / champagne / шампань	



Rączka GEO 18
Handle GEO 18
Ручка GEO 18

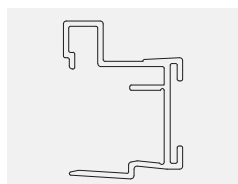





	 L mm		
A-R18GEO2-270-05	2700	aluminium / aluminium / алюминий	aluminium / aluminium / алюминий



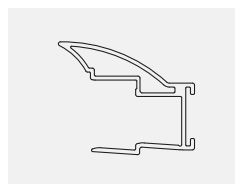

Rączka NOVO 2
Handle NOVO 2
Ручка NOVO 2



	 L mm		
A-RNOV2-270-05	2700	aluminium / aluminium / алюминий	aluminium aluminium алюминий
A-RNOV2-270-10		biały / white / белый	
A-RNOV2-270-20M		czarny mat / black matt / чёрный матовый	
A-RNOV2-270-90		szampan / champagne / шампань	



Rączka NOVO S
Handle NOVO S
Ручка NOVO S

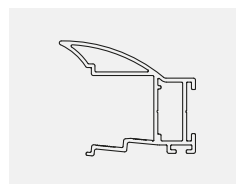







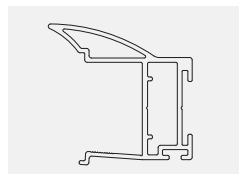

	 L mm		
A-R18NOVS-270-05	2700	aluminium / aluminium / алюминий	aluminium aluminium алюминий
A-R18NOVS-270-10		biały / white / белый	
A-R18NOVS-270-20M		czarny / black / чёрный	
A-R18NOVS-270-90		szampan / champagne / шампань	











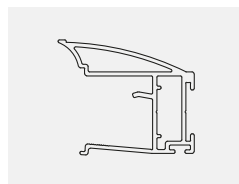

Rączka NOVO S 19
Handle NOVO S 19
Ручка NOVO S 19



	 L mm		
A-R19NOVS-300-05	3000	aluminium / aluminium / алюминий	aluminium / aluminium / алюминий
 BOARD 19 mm	 FRAME	 FRAMELESS	 × 24







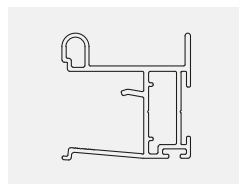

Rączka CARO
Handle CARO
Ручка CARO



	 L mm		
A-R18CARO-270-05	2700	aluminium / aluminium / алюминий	aluminium
A-R18CARO-270-90		szampan / champagne / шампань	aluminium aluminium алюминий
 BOARD 18 mm	 GLASS 4 mm	 FRAME	 FRAMELESS
			 × 20

Rączka VISTA
Handle VISTA
Ручка VISTA



	 L mm		
A-R18VIS-270-05	2700	aluminium / aluminium / алюминий	aluminium
A-R18VIS-270-20M		czarny mat / black matt / чёрный матовый	aluminium
A-R18VIS-270-90		szampan / champagne / шампань	aluminium aluminium алюминий
 BOARD 18 mm	 GLASS 4 mm	 FRAME	 FRAMELESS
			 × 24

Rączka NERO
Handle NERO
Ручка NERO

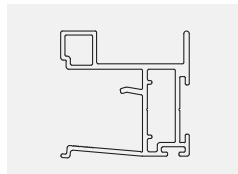

	 mm		
A-R18NERO-270-05	2700	aluminium / aluminium / алюминий	aluminium aluminium алюминий
A-R18NERO-270-10		biały / white / белый	
A-R18NERO-270-20M		czarny / black / чёрный	
A-R18NERO-270-90		szampan / champagne / шампань	

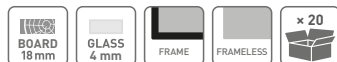

Rączka NERO 19
Handle NERO 19
Ручка NERO 19

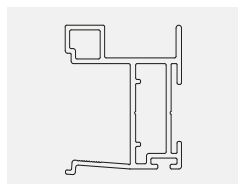

	 mm		
A-R19NERO-300-05	3000	aluminium / aluminium / алюминий	aluminium / aluminium / алюминий



Rączka COTE
Handle COTE
Ручка COTE

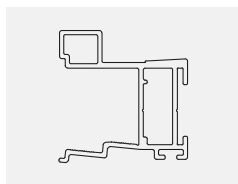

	 mm		
A-R18COTE-270-05	2700	aluminium / aluminium / алюминий	aluminium aluminium алюминий
A-R18COTE-270-90		szampan / champagne / шампань	



Rączka LOCA
Handle LOCA
Ручка LOCA

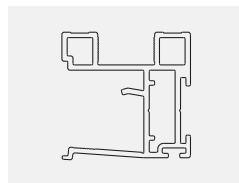

A-R18LOCA-305-05	3050	aluminium / aluminium / алюминий	aluminium aluminium алюминий
A-R18LOCA-305-90		szampan / champagne / шампань	



Rączka FLAT LINE
Handle FLAT LINE
Ручка FLAT LINE

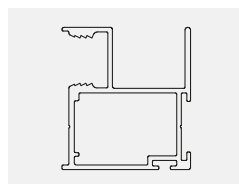

A-R10FL-270-05	2700	aluminium / aluminium / алюминий	aluminium aluminium алюминий
A-R10FL-270-10		biały / white / белый	
A-R10FL-270-20M		czarny mat / black matt / чёрный матовый	
A-R10FL-270-90		szampan / champagne / шампань	



Rączka MOVENA
Handle MOVENA
Ручка MOVENA

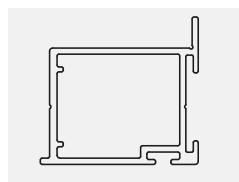

A-R4MOV-270-05	2700	aluminium / aluminium / алюминий	aluminium aluminium алюминий

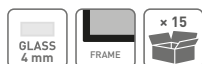

Rączka NOVO 10
Handle NOVO 10
Ручка NOVO 10

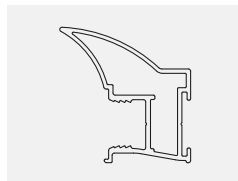

	 L mm		
A-R10NOV-270-05	2700	aluminium / aluminium / алюминий	aluminium aluminium алюминий
A-R10NOV-270-10		biały / white / белый	
A-R10NOV-270-20M		czarny mat / black matt / чёрный матовый	
A-R10NOV-270-90		szampan / champagne / шампань	



Rączka FORM
Handle FORM
Ручка FORM

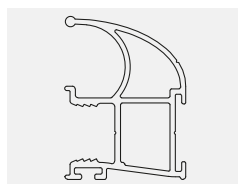

	 L mm		
A-R10FORM-270-05	2700	aluminium / aluminium / алюминий	aluminium aluminium алюминий
A-R10FORM-270-90		biały / white / белый	



Rączka TRAF0
Handle TRAF0
Ручка TRAF0



	 L mm		
A-R10TRAF0-270-05	2700	aluminium / aluminium / алюминий	aluminium aluminium алюминий
A-R10TRAF0-270-90		szampan / champagne / шампань	



Rączka TORO
Handle TORO
Ручка TORO

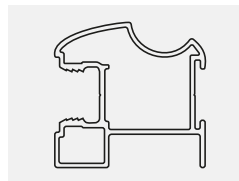
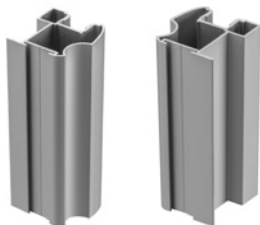

A-R10TORO-270-05	2700	aluminium / aluminium / алюминий	aluminium aluminium алюминий
A-R10TORO-270-90		szampan / champagne / шампань	



Rączka FALDA
Handle FALDA
Ручка FALDA

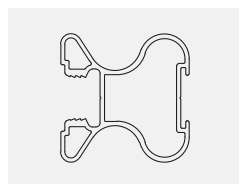

A-R10FALDA-270-05	2700	aluminium / aluminium / алюминий	aluminium aluminium алюминий
A-R10FALDA-270-90		szampan / champagne / шампань	



Rączka ARCO*
Handle ARCO*
Ручка ARCO*

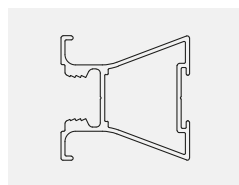





A-R10ARCO-270-05	2700	aluminium / aluminium / алюминий	aluminium aluminium алюминий
A-R10ARCO-270-90		szampan / champagne / шампань	

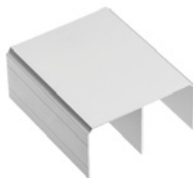

Tor górny
Top track
Верхняя направляющая



	 L mm		
A-TG-170-05	1700	aluminium / aluminium / алюминий	
A-TG-170-10		biały / white / белый	
A-TG-170-20M		czarny / black / чёрный	
A-TG-170-90		szampan / champagne / шампань	
A-TG-235-05	2350	aluminium / aluminium / алюминий	aluminium aluminium алюминий
A-TG-235-10		biały / white / белый	
A-TG-235-20M		czarny / black / чёрный	
A-TG-235-90		szampan / champagne / шампань	
A-TG-300-05	3000	aluminium / aluminium / алюминий	
A-TG-300-10		biały / white / белый	
A-TG-300-20M		czarny / black / чёрный	
A-TG-300-90		szampan / champagne / шампань	
A-TG-405-05	4050	aluminium / aluminium / алюминий	
A-TG-405-10		biały / white / белый	
A-TG-405-20M		czarny / black / чёрный	
A-TG-405-90		szampan / champagne / шампань	
A-TG-600-05	6000	aluminium / aluminium / алюминий	
A-TG-600-10		biały / white / белый	
A-TG-600-20M		czarny / black / чёрный	
A-TG-600-90		szampan / champagne / шампань	



Tor dolny EVO Bottom track EVO Нижняя направляющая EVO







	 L mm		
A-TDEVO-170-05	1700	aluminium / aluminium / алюминий	aluminium aluminium алюминий
A-TDEVO-170-10		biały / white / белый	
A-TDEVO-170-20M		czarny / black / чёрный	
A-TDEVO-170-90		szampan / champagne / шампань	
A-TDEVO-235-05	2350	aluminium / aluminium / алюминий	
A-TDEVO-235-10		biały / white / белый	
A-TDEVO-235-20M		czarny / black / чёрный	
A-TDEVO-235-90		szampan / champagne / шампань	
A-TDEVO-300-05	3000	aluminium / aluminium / алюминий	
A-TDEVO-300-10		biały / white / белый	
A-TDEVO-300-20M		czarny / black / чёрный	
A-TDEVO-300-90		szampan / champagne / шампань	
A-TDEVO-405-05	4050	aluminium / aluminium / алюминий	
A-TDEVO-405-10		biały / white / белый	
A-TDEVO-405-20M		czarny / black / чёрный	
A-TDEVO-405-90		szampan / champagne / шампань	
A-TDEVO-600-05	6000	aluminium / aluminium / алюминий	
A-TDEVO-600-10		biały / white / белый	
A-TDEVO-600-20M		czarny / black / чёрный	
A-TDEVO-600-90		szampan / champagne / шампань	



Maskownica EVO Masking cover EVO Декоративная накладка



	 L mm		
A-MEVO-170-05	1700	aluminium / aluminium / алюминий	aluminium aluminium алюминий
A-MEVO-170-10A		biały / white / белый	
A-MEVO-170-20M		czarny / black / чёрный	
A-MEVO-170-90		szampan / champagne / шампань	
A-MEVO-235-05	2350	aluminium / aluminium / алюминий	
A-MEVO-235-10A		biały / white / белый	
A-MEVO-235-20M		czarny / black / чёрный	
A-MEVO-235-90		szampan / champagne / шампань	
A-MEVO-300-05	3000	aluminium / aluminium / алюминий	
A-MEVO-300-10A		biały / white / белый	
A-MEVO-300-20M		czarny / black / чёрный	
A-MEVO-300-90		szampan / champagne / шампань	
A-MEVO-405-05	4050	aluminium / aluminium / алюминий	
A-MEVO-405-10		biały / white / белый	
A-MEVO-405-20M		czarny / black / чёрный	
A-MEVO-405-90		szampan / champagne / шампань	



Tor dolny EVO 2
Bottom track EVO 2
Нижняя направляющая EVO 2



	 L mm		
A-TDEVO2-170-05	1700	aluminium / aluminium / алюминий	aluminium aluminium алюминий
A-TDEVO2-170-90		szampan / champagne / шампань	
A-TDEVO2-235-05	2350	aluminium / aluminium / алюминий	
A-TDEVO2-235-90		szampan / champagne / шампань	
A-TDEVO2-300-05	3000	aluminium / aluminium / алюминий	
A-TDEVO2-300-90		szampan / champagne / шампань	
A-TDEVO2-405-05	4050	aluminium / aluminium / алюминий	
A-TDEVO2-405-90		szampan / champagne / шампань	
A-TDEVO2-600-05	6000	aluminium / aluminium / алюминий	
A-TDEVO2-600-90		szampan / champagne / шампань	



Tor dolny PRO
Bottom track PRO
Нижняя направляющая PRO



	 L mm		
A-TDPRO-170-05	1700	aluminium / aluminium / алюминий	aluminium aluminium алюминий
A-TDPRO-170-10		biały / white / белый	
A-TDPRO-170-20M		czarny / black / чёрный	
A-TDPRO-170-90	szampan / champagne / шампань		
A-TDPRO-235-05	2350	aluminium / aluminium / алюминий	
A-TDPRO-235-10		biały / white / белый	
A-TDPRO-235-20M		czarny / black / чёрный	
A-TDPRO-235-90	szampan / champagne / шампань		
A-TDPRO-300-05	3000	aluminium / aluminium / алюминий	
A-TDPRO-300-10		biały / white / белый	
A-TDPRO-300-20M		czarny / black / чёрный	
A-TDPRO-300-90	szampan / champagne / шампань		
A-TDPRO-405-05	4050	aluminium / aluminium / алюминий	
A-TDPRO-405-10		biały / white / белый	
A-TDPRO-405-20M		czarny / black / чёрный	
A-TDPRO-405-90	szampan / champagne / шампань		
A-TDPRO-600-05	6000	aluminium / aluminium / алюминий	
A-TDPRO-600-10		biały / white / белый	
A-TDPRO-600-20M		czarny / black / чёрный	
A-TDPRO-600-90	szampan / champagne / шампань		



Maskownica PRO Masking cover PRO Декоративная накладка PRO



	 L mm		
A-MPRO-170-05	1700	aluminium / aluminium / алюминий	aluminium aluminium алюминий
A-MPRO-170-10		biały / white / белый	
A-MPRO-170-20M		czarny / black / чёрный	
A-MPRO-170-90	2350	szampan / champagne / шампань	
A-MPRO-235-05		aluminium / aluminium / алюминий	
A-MPRO-235-10		biały / white / белый	
A-MPRO-235-20M	3000	czarny / black / чёрный	
A-MPRO-235-90		szampan / champagne / шампань	
A-MPRO-300-05		aluminium / aluminium / алюминий	
A-MPRO-300-10	4050	biały / white / белый	
A-MPRO-300-20M		czarny / black / чёрный	
A-MPRO-300-90		szampan / champagne / шампань	
A-MPRO-405-05	4050	aluminium / aluminium / алюминий	
A-MPRO-405-10		biały / white / белый	
A-MPRO-405-20M		czarny / black / чёрный	
A-MPRO-405-90		szampan / champagne / шампань	



Listwa górna 18/4 mm Top strip 18/4 mm Профиль горизонтальный верхний 18/4 мм

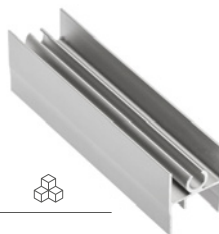

	 L mm		
A-LG18-170-05	1700	aluminium / aluminium / алюминий	aluminium aluminium алюминий
A-LG18-170-90		szampan / champagne / шампань	
A-LG18-235-05	2350	aluminium / aluminium / алюминий	
A-LG18-235-90		szampan / champagne / шампань	
A-LG18-300-05	3000	aluminium / aluminium / алюминий	
A-LG18-300-10		biały / white / белый	
A-LG18-300-20M		czarny / black / чёрный	
A-LG18-300-90	4050	szampan / champagne / шампань	
A-LG18-405-05		aluminium / aluminium / алюминий	
A-LG18-405-10		biały / white / белый	
A-LG18-405-90	6000	szampan / champagne / шампань	
A-LG18-600-05		aluminium / aluminium / алюминий	
A-LG18-600-90		szampan / champagne / шампань	



Listwa dolna 18/4 mm
Bottom strip 18/4 mm
Профиль горизонтальный нижний 18/4 мм



	 L mm		
A-LD18-170-05	1700	aluminium / aluminium / алюминий	aluminium aluminium алюминий
A-LD18-170-90		szampan / champagne / шампань	
A-LD18-235-05	2350	aluminium / aluminium / алюминий	
A-LD18-235-90		szampan / champagne / шампань	
A-LD18-300-05	3000	aluminium / aluminium / алюминий	
A-LD18-300-10		biały / white / белый	
A-LD18-300-20M		czarny / black / чёрный	
A-LD18-300-90	szampan / champagne / шампань		
A-LD18-405-05	4050	aluminium / aluminium / алюминий	
A-LD18-405-10		biały / white / белый	
A-LD18-405-90		szampan / champagne / шампань	
A-LD18-600-05	6000	aluminium / aluminium / алюминий	
A-LD18-600-90		szampan / champagne / шампань	



Listwa górna 19 mm
Top strip 19 mm
Профиль горизонтальный верхний 19 мм

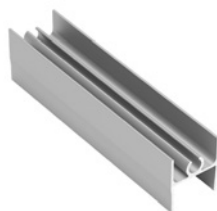

	 L mm		
A-LG19-300-05	3000	aluminium aluminium алюминий	aluminium aluminium алюминий



Listwa dolna 19 mm
Bottom strip 19 mm
Профиль горизонтальный нижний 19 мм





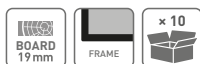

	 L mm		
A-LD19-300-05	3000	aluminium aluminium алюминий	aluminium aluminium алюминий

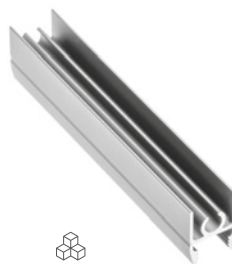

Listwa górna 10/4 mm
Top strip 10/4 mm
Профиль горизонтальный верхний 10/4 мм







	 L mm		
A-LG10-170-05	1700	aluminium / aluminium / алюминий	aluminium aluminium алюминий
A-LG10-235-05	2350	aluminium / aluminium / алюминий	
A-LG10-235-90		szampan / champagne / шампань	
A-LG10-300-05	3000	aluminium / aluminium / алюминий	
A-LG10-300-10		biały / white / белый	
A-LG10-300-20M		czarny mat / black matt / чёрный матовый	
A-LG10-300-90		szampan / champagne / шампань	
A-LG10-405-05	4050	aluminium / aluminium / алюминий	
A-LG10-405-90		szampan / champagne / шампань	
A-LG10-600-05	6000	aluminium / aluminium / алюминий	
A-LG10-600-90		szampan / champagne / шампань	



Listwa dolna 10/4 mm
Bottom strip 10/4 mm
Профиль горизонтальный нижний 10/4 мм







	 mm		
A-LD10-170-05	1700	aluminium / aluminium / алюминий	aluminium aluminium алюминий
A-LD10-235-05	2350	aluminium / aluminium / алюминий	
A-LD10-235-90		szampan / champagne / шампань	
A-LD10-300-05	3000	aluminium / aluminium / алюминий	
A-LD10-300-10		biały / white / белый	
A-LD10-300-20M		czarny mat / black matt / чёрный матовый	
A-LD10-300-90		szampan / champagne / шампань	
A-LD10-405-05	4050	aluminium / aluminium / алюминий	
A-LD10-405-90		szampan / champagne / шампань	
A-LD10-600-05	6000	aluminium / aluminium / алюминий	
A-LD10-600-90		szampan / champagne / шампань	



Listwa górna 4 mm
Top strip 4 mm
Профиль горизонтальный верхний 4 мм





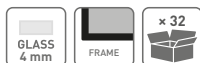

	 mm		
A-LG4MOV-300-05	3000	aluminium / aluminium / алюминий	aluminium aluminium алюминий



Listwa dolna 4 mm
Bottom strip 4 mm
Профиль горизонтальный нижний 4 мм



	 L mm		
A-LD4MOV-300-05	3000	aluminium / aluminium / алюминий	aluminium aluminium алюминий

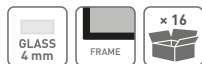

Listwa górna FL 10/4 mm
Top strip FL 10/4 mm
Профиль горизонтальный верхний FL 10/4 мм

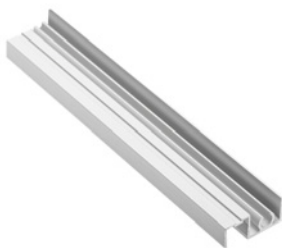





	 L mm		
A-LG10FL-300-05	3000	aluminium / aluminium / алюминий	aluminium aluminium алюминий
A-LG10FL-300-10		biały / white / белый	
A-LG10FL-300-20M		czarny mat / black matt / чёрный матовый	
A-LG10FL-300-90		szampan / champagne / шампань	



Listwa dolna FL 10,4 mm
 Bottom strip FL 10/4 mm
 Профиль горизонтальный нижний FL 10/4 мм



			
A-LD10FL-300-05	3000	aluminium / aluminium / алюминий	aluminium aluminium алюминий
A-LD10FL-300-10		biały / white / белый	
A-LD10FL-300-20M		czarny mat / black matt / чёрный матовый	
A-LD10FL-300-90		szampan / champagne / шампань	



Kątownik
 Angle bar
 Профиль угловой





			
A-K18-300-05	3000	aluminium / aluminium / алюминий	aluminium aluminium алюминий
A-K18-300-10		biały / white / белый	
A-K18-300-20M		czarny / black / чёрный	
A-K18-300-90		szampan / champagne / шампань	



Profil C18
Profile C18
Профиль C18







	 mm		
A-C18-300-S-05	3000	aluminium / aluminium / алюминий	aluminium aluminium алюминий
A-C18-300-S-10		biały / white / белый	
A-C18-300-S-20M		czarny mat / black matt / чёрный матовый	
A-C18-300-S-90		szampan / champagne / шампань	



Profil T18
Profile T18
Профиль T18







	 mm		
A-T18-300-05	3000	aluminium / aluminium / алюминий	aluminium aluminium алюминий
A-T18-300-10		biały / white / белый	
A-T18-300-90		szampan / champagne / шампань	



Profil H16
Profile H16
Профиль H16







	 mm		
A-H16-300-05	3000	aluminium / aluminium / алюминий	aluminium aluminium алюминий
A-H16-300-90		szampan / champagne / шампань	





Profil H18
 Profile H18
 Профиль H18







	 L mm		
A-H18-300-05	3000	aluminium / aluminium / алюминий	aluminium aluminium алюминий
A-H18-300-10		biały / white / белый	
A-H18-300-20M		czarny / black / чёрный	
A-H18-300-90		szampan / champagne / шампань	

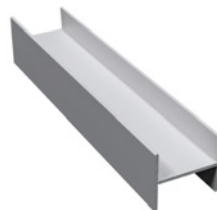

Profil H18 RA
 Profile H18 RA
 Профиль H18 RA



	 L mm		
A-HR18-300-05RA	3000	aluminium / aluminium / алюминий	aluminium aluminium алюминий
A-HR18-300-90RA		szampan / champagne / шампань	



Profil HR18
Profile HR18
Профиль HR18

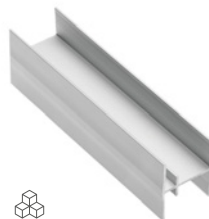





	  L mm		
A-HR18-300-05	3000	aluminium / aluminium / алюминий	aluminium aluminium алюминий
A-HR18-300-10		biały / white / белый	
A-HR18-300-20M		czarny / black / чёрный	
A-HR18-300-90		szampan / champagne / шампань	

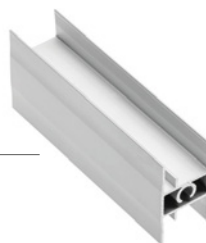

Profil HRS18
Profile HRS18
Профиль HRS18



	  L mm		
A-HRS18-170-05	1700	aluminium / aluminium / алюминий	aluminium aluminium алюминий
A-HRS18-170-90		szampan / champagne / шампань	
A-HRS18-235-05	2350	aluminium / aluminium / алюминий	
A-HRS18-235-90		szampan / champagne / шампань	
A-HRS18-300-05	3000	aluminium / aluminium / алюминий	
A-HRS18-300-90		szampan / champagne / шампань	
A-HRS18-405-05	4050	aluminium / aluminium / алюминий	
A-HRS18-405-90		szampan / champagne / шампань	
A-HRS18-600-05	6000	aluminium / aluminium / алюминий	
A-HRS18-600-90		szampan / champagne / шампань	



Profil HR19
Profile HR19
Профиль HR19

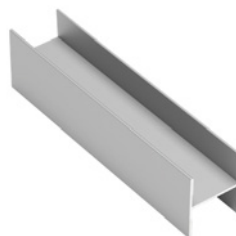





	  L mm		
A-HR19-300-05	3000	aluminium / aluminium / алюминий	aluminium / aluminium / алюминий



Profil HR10
Profile HR10
Профиль HR10







	 L mm		
A-HR10-235-05*	2350	aluminium / aluminium / алюминий	aluminium aluminium алюминий
A-HR10-235-90*		szampan / champagne / шампань	
A-HR10-300-05	3000	aluminium / aluminium / алюминий	
A-HR10-300-10		biały / white / белый	
A-HR10-300-90	szampan / champagne / шампань		
A-HR10-405-05*	4500	aluminium / aluminium / алюминий	
A-HR10-405-90*		szampan / champagne / шампань	
A-HR10-600-05*	6000	aluminium / aluminium / алюминий	
A-HR10-600-90*		szampan / champagne / шампань	

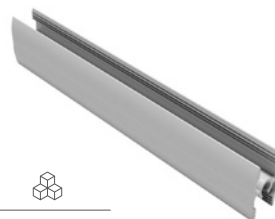

* Do wyczerpania zapasów / Until stocks run out / До исчерпания запасов

Profil HRS10
Profile HRS10
Профиль HRS10







	 L mm		
A-HRS10-170-05*	1700	aluminium / aluminium / алюминий	aluminium aluminium алюминий
A-HRS10-300-05	3000	szampan / champagne / шампань	
A-HRS10-300-90		szampan / champagne / шампань	
A-HRS10-405-05*	4050	aluminium / aluminium / алюминий	
A-HRS10-600-05*	6000	aluminium / aluminium / алюминий	



* Do wyczerpania zapasów / Until stocks run out / До исчерпания запасов

Profil HR10 FL
Profile HR10 FL
Профиль HR10 FL





	 L mm		
A-HR10FL-300-05	3000	aluminium / aluminium / алюминий	aluminium aluminium алюминий
A-HR10FL-300-10		biały / white / белый	
A-HR10FL-300-20M		czarny mat / black matt / чёрный матовый	
A-HR10FL-300-90		szampan / champagne / шампань	



Prowadnik górny PG-18
 Top roller PG-18
 Верхний ролик PG-18





		
A-PG-18	50	stal, tworzywo steel, plastic сталь, пластмасса



Prowadnik górny PGR-18
 Top roller PGR-18
 Верхний ролик PGR-18





		
A-PGR-18	50	stal, tworzywo steel, plastic сталь, пластмасса



Prowadnik górny PGR-10
 Top roller PGR-10
 Верхний ролик PGR-10





		
A-PGR-10	50	stal, tworzywo steel, plastic сталь, пластмасса



Prowadnik górny PGR-10 symetryczny
 Top roller PGR-10 symmetrical
 Верхний ролик PGR-10 симметричный





		
A-PGR-10S	50	stal, tworzywo steel, plastic сталь, пластмасса



Płytk dystansowa
 Spacer plate
 Распорная пластина





		
A-DPG-16	50	stal steel сталь



Wózek dolny EVO 2
 Bottom roller EVO 2
 Нижний ролик EVO 2





		
A-WD-EVO2	50	stal / tworzywo steel / plastic сталь / пластмасса



Zaczep EVO 2
Guide EVO 2
Зацепка EVO 2





		
A-ZAC-WDEV02	50	stal, tworzywo steel, plastic сталь, пластмасса



Wózek dolny PRO
Bottom roller PRO
Нижний ролик PRO





		
A-WD-PRO	50	stal, tworzywo steel, plastic сталь, пластмасса



Wózek dolny EVO rama
Bottom roller EVO frame
Нижний ролик EVO для рамной системы





		
A-WDR-EVO	50	stal, tworzywo steel, plastic сталь, пластмасса



Wózek dolny PRO rama
Bottom roller PRO frame
Нижний ролик PRO для рамной системы





		
A-WDR-PRO	50	stal, tworzywo steel, plastic сталь, пластмасса



Pozycjoner górny
Top positioner
Верхний стопор





		
A-PTG	50	tworzywo plastic пластмасса



Pozycjoner dolny PRO
Bottom positioner PRO
Нижний стопор PRO



		
A-PTD	50	stal steel сталь



Szczotka odbojowa 4,8 x 4 mm
Buffer strip 4,8 x 4 mm
Буферная щётка 4,8 x 4 мм





		
A-SO-48X4	szary / gray / серый	tworzywo plastic пластмасса
A-SO-48X4-20	czarny / black / чёрный	



Szczotka odbojowa szeroka 14,5 x 4 mm
Buffer strip wide 14,5 x 4 mm
Буферная щётка широкая 4,8 x 4 мм



		
A-SO-145X4	szary / gray / серый	tworzywo plastic пластмасса
A-SO-145X4-10	biały / white / белый	
A-SO-145X4-20	czarny / black / чёрный	



Szczotka przeciwkurzowa bez kleju 4,8 x 7 mm
Anti-dust strip without glue 4,8 x 7 mm
Противопылевая щётка без клея 4,8 x 7 мм



		
A-SP-48X7	szary gray серый	tworzywo plastic пластмасса



Szczotka przeciwkurzowa z klejem 7 x 12 mm
 Anti-dust strip with glue 7 x 12 mm
 Противопылевая щётка на клеевой основе 7 x 12 мм



		
A-SP-7X12	szary gray серый	tworzywo plastic пластмасса



Szczotka przeciwkurzowa bez kleju 4,8 x 12 mm
 Anti-dust strip without glue 4,8 x 12 mm
 Противопылевая щётка 4,8 x 12 мм (вставная)



		
A-SP-48X12	szary gray серый	tworzywo plastic пластмасса



Klin do rączek
 Wedge for handle
 Клин для профиль-ручки



		
A-KR-4	biały / white / белый	tworzywo plastic пластмасса
A-KR-4-20	czarny / black / чёрный	



Klin do listew poziomych
Wedge for horizontal strips
Клин для горизонтальных профилей





		
A-KLP-4	biały / white / белый	tworzywo plastic пластмасса
A-KLP-4-20	czarny / black / чёрный	



Klips do mocowania toru dolnego EVO 2
Mounting clip for bottom track EVO 2
Клипса для крепления нижней направляющей EVO 2



		
A-ZAT-TDEV02	mleczny milk молочный	tworzywo plastic пластмасса



Uszczelka typ U, średnio twarda
Gasket U, medium hard
Уплотнитель тип U, средней твердости



			
A-USZCZ-U4	100	przeźroczysty transparent прозрачный	tworzywo plastic пластмасса



Uszczelka typ CH, miękka
Gasket CH, soft
Уплотнитель типа CH, мягкий







	 L m		
A-USZCZ-CHM4	120	przeźroczysty / transparent / прозрачный	tworzywo plastic пластмасса
A-USZCZ-CHM4-20	150	czarny / black / чёрный	



Uszczelka do toru dolnego EVO 2
Gasket for EVO 2 track
Уплотнитель для нижней направляющей EVO 2



	 L m		
A-USZCZ-TDEVO2	200	mleczny milk молочный	PVC



Błachowkręt 6,3 x 40 mm
Steel metal screw 6,3 x 40 mm
Сборочный винт 6,3 x 40 мм



	
A-B63-40	stal steel сталь



Blachowkręt 6,3 x 32 mm
Steel metal screw 6,3 x 32 mm
Сборочный винт 6,3 x 32 мм





	
A-B63-32*	stal steel сталь



* Do wyczerpania zapasów / Until stocks run out / До исчерпания запасов

Spowalniczak SIMON skrajny
Internal soft closing damper SIMON
Боковой доводчик SIMON



		
A-SOFT-30*	30	stal, tworzywo steel, plastic сталь, пластмасса
A-SOFT-50*	50	

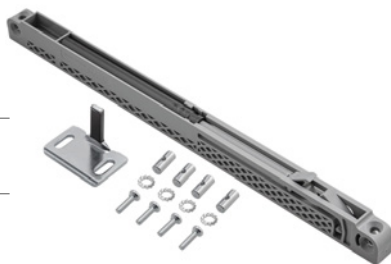

* Do wyczerpania zapasów / Until stocks run out / До исчерпания запасов



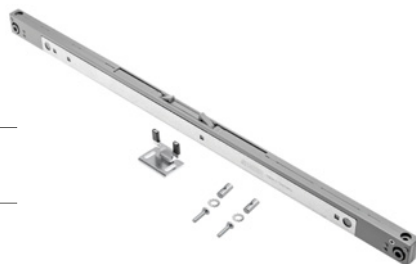

Spowalniczak SIMON środkowy
Internal soft closing damper SIMON
Центральный доводчик SIMON

		
A-MSOFT-RAMA	50	stal, tworzywo steel, plastic сталь, пластмасса





Spowalniczak ZIMMER skrajny
Internal soft closing damper ZIMMER
Боковой доводчик ZIMMER

		
A-SOFT-30Z	30	stal, tworzywo steel, plastic сталь, пластмасса
A-SOFT-50Z	50	



Zestaw adaptera do spowalnicza środkowego
 Adapter set for soft closing damper
 Адаптер для доводчика

		
A-MSOFT-ADAPT	50	stal steel сталь





Zamek do systemów przesuwnych
 Lock for sliding door systems
 Замок для раздвижных систем

	
ZZ-SP-105-05	stal, tworzywo steel, plastic сталь, пластмасса



Ręczny przyrząd wiertarski z dociskiem
 Hand drilling tool with locking screws
 Ручной сверлильный кондуктор с зажимом

	
A-PW-RC-DOC	stal steel сталь



MITO
MITO
MITO

	Tor MITO Track MITO Направляющая MITO	A-TMITO-200-00	200	50	surowe aluminium raw aluminum сырой алюминий	aluminium aluminium алюминий	56
		A-TMITO-250-00	250				
		A-TMITO-300-00	300				
		A-TMITO-200-05	200		aluminium aluminium алюминий		
		A-TMITO-250-05	250				
		A-TMITO-300-05	300				
	Pozycjoner Positioner Стопор	A-POZ-MITO	-		szary gray серый	tworzywo plastic пластмасса	1000
	Wózek górny Top guide Верхний проводник	A-SG-MITO	-		ocynk zink оцинковка	stal, tworzywo steel, plastic сталь, пластмасса	100
	Wózek dolny z łożyskiem kulkowym Bottom roller with ball bearing Нижний ролик с шариковым подшипником	A-RD-MITO	-				

Zestaw MITO PLUS
MITO PLUS set
MITO PLUS комплект

2 wózki górne ze sprężyną, 2 wózki dolne z łożyskiem kulkowym, 1 pozycjoner, komplet wkrętów

2 top rollers with spring, 2 bottom ball bearing rollers, 1 positioner, set of screws

2 верхних проводника с пружиной, 2 нижних ролика с шариковым подшипником, 1 стопор, комплект шурупов



A-MITO-PLUS	50	ocynk / zink / оцинковка	stal / steel / сталь
-------------	----	--------------------------	----------------------



Zestaw OVERLINE
OVERLINE set
OVERLINE комплект



2 szt. wózków zewnętrznych, 2 szt. wózków wewnętrznych, 2 szt. pozycjonerów, 2 szt. prowadników dolnych ślizgowych drzwi zewnętrznych, 2 szt. prowadników dolnych ślizgowych drzwi wewnętrznych

2 external rollers, 2 internal rollers, 2 positioners, 2 bottom slides for external door, 2 bottom slides of internal door

Внешние ролики-2шт., внутренние ролики-2шт., нижние ходовые элементы внешней двери-2 шт., нижние ходовые элементы внутренней двери-2 шт., позиционер-2 шт

A-SN-FSET	50	ocynk / zink / оцинковка	stal, tworzywo / steel, plastic / сталь, пластмасса	10

	A-SN-R19RIV-270-05	-	aluminium aluminium алюминий	aluminium aluminium алюминий	24	
	A-SN-K19-270-05	-			48	
	A-C18-300-S-05	3000			50	
	A-SN-TG-405-00	4050	50	surowe aluminium raw aluminium сырой алюминий	stal steel сталь	80
	A-SN-TDS-405-00			aluminium aluminium алюминий	40	
	A-SN-SOFT-25	-	25	szary gray серый	tworzywo plastic пластмасса	100
	A-SN-SOFT-40	-	40			
	A-SN-ADSET	-	-	-	stal, tworzywo steel, plastic сталь, пластмасса	100



Zestaw OVERLINE PLUS
OVERLINE PLUS set
OVERLINE PLUS комплектация



2 szt. wózków zewnętrznych, 2 szt. wózków wewnętrznych, 2 szt. prowadników dolnych tocznych drzwi zewnętrznych, 2 szt. prowadników dolnych tocznych drzwi wewnętrznych, 1 zestaw wkrętów

2 external rollers, 2 internal rollers, 2 bottom slides for external door, 2 bottom slides for internal door, screws

Составляющие: внешние ролики – 2шт., внутренние ролики – 2шт., нижние ходовые элементы внешней двери – 2 шт., нижние ходовые элементы внутренней двери – 2 шт., 1 клп. шурупов

A-SN-HSET1	50	ocynk / zink / оцинковка	stal, tworzywo / steel, plastic / сталь, пластмасса	1			
	Rączka RIVA Handle RIVA Ручка RIVA	A-SN-R19RIV-270-05	2700	-	aluminium aluminium алюминий	aluminium aluminium алюминий	24
	Profil C19 Handle C19 Ручка C19	A-SN-K19-270-05		-			48
	Profil C18 Handle C18 Ручка C18	A-C18-300-S-05		3000			-
	Tor górny Top track Верхняя направляющая	A-SN-TG-405-00	4050	-	surowe aluminium raw aluminium сырой алюминий	stal steel сталь	80
	Tor dolny Bottom track Нижняя направляющая	A-SN-TDT-405-00		-	aluminium aluminium алюминий	20	
	Spowalniacz Soft closing damper доводчик	A-SN-SOFT-25	-	25	-	tworzywo plastic пластмасса	100
		A-SN-SOFT-40	-	40	-		
	Pozycjoner Positioner Стоп	A-SN-POZ	-	-	czarny black черный		20
	Zestaw do spowalniacza Soft closing damper set доводчик комплектация 1 szt. aktywator drzwi zewn. i 1 szt. wewn., 4 szt. adapterów, 1 zestaw wkrętów 1 pc activator outer door and 1 pc inner door, 4 pcs adapter, 1 screw set активатор внеш. двери - 1 шт., активатор внутр. двери - 1 шт., адаптер - 4 шт., 1 клп. шурупов	A-SN-ADSET	-	-	-	stal, tworzywo steel, plastic сталь, пластмасса	100

Prostownica Warped door straightener Стяжка-выпрямитель

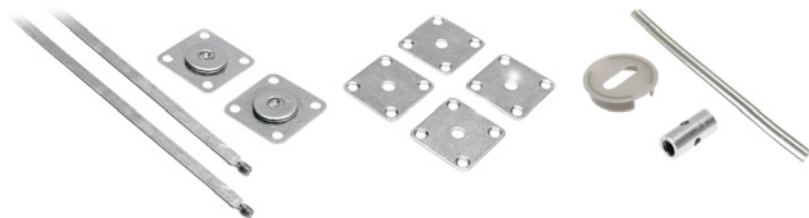

2 szt. listwy ściągające, 2 szt. płytki naciągające, 4 szt. płytki dociskowej, zaślepka, tuleja pozycjonująca, klucz do regulacji
Tightening strip - 2 pcs, tensioning plate - 2 pcs, pressure plate - 4 pcs, cover cap, positioning sleeve, adjustment spanner
Планка с резьбой - 2 шт., натяжная пластина - 2 шт., прижимная пластина - 4 шт., заглушка, зажимная гильза, ключ для регулировки

			
A-SN-SDP-TU	50	ocynk / zink / оцинковка	stal, tworzywo / steel, plastic / сталь, пластмасса



Zestaw QUANTUM
 QUANTUM set
 Комплект QUANTUM



2 szt. wózków, 2 szt. stoperów, 2 szt. przewodników, komplet wkrętów
 Rollers - 2 pcs, stoppers - 2 pcs, guide - 2 pcs, screw set
 Ролики - 2 шт., стопор - 2 шт., проводник - 2 шт., комплект шурупов

A-BUDP-SET	50	aluminium / aluminium / алюминий	stal, tworzywo / steel, plastic / сталь, пластмасса	24

<p>Top górny Top track Верхняя направляющая</p>	A-TG-BUD-200-00	2000	50	surowe aluminium raw aluminium сырой алюминий	aluminium aluminium алюминий	15
	A-TG-BUD-300-00	3000				
<p>Uchwyt boczny Side holder Боковое крепление</p>	A-BUD-UB	-		ocynk zink оцинковка	stal steel сталь	200
<p>Uchwyt górny Top holder Верхнее крепление</p>	A-BUD-UG	-				
<p>Uchwyt maskownicy toru górnego Top track masking cover holder Держатель декоративной панели</p>	A-BUD-UM	60		aluminium aluminium алюминий	aluminium aluminium алюминий	250
<p>Uchwyt do ramy (4 szt.) Frame holder (4 pcs) Крепление плиты (4 шт.)</p>	A-BUD-UR	-		szary gray серый	stal, tworzywo steel, plastic сталь, пластмасса	100
<p>Uchwyt do płyty Board holder Держатель для плиты</p>	A-BUD-UP	-	ocynk zink оцинковка	stal steel сталь		



Zestaw LOFT
LOFT set
Комплект LOFT



2 szt. wózków, prowadnik, tor 2 m, 5 sztuk tulei dystansowych, 2 szt. odbojników, 2 szt. zabezpieczeń przed wypadnięciem drzwi, 2 szt. spawalniaczy, 2 szt. aktywatorów, komplet wkrętów i śrub

Roller – 2 pcs, slide – 1 pc, track 2 m, distance sleeve – 5 pcs, bumper 2 pcs, stopper preventing door from falling out – 2 pcs, soft closing damper – 2 pcs, activator – 2 pcs, screw set

Ролик – 2 шт., prowadnik – 1 шт., Направляющая 2 м, Амортизатор – 2 шт., блокада – 2 шт., доводчик – 2 шт., активатор – 2 шт., кпл. шурупов



A-SN-LOFT-200-20MN

100

czarny / black / чёрный

stal, tworzywo / steel, plastic / сталь, пластмасса

1



Polecany uchwyt w stylu loft - UZ-STEP-160-20M
Recommended loft-style handle - UZ-STEP-160-20M
Рекомендуем ручку в стиле лофт - UZ-STEP-160-20M



**OŚWIETLENIE MEBLOWE
FURNITURE LIGHTING
МЕБЕЛЬНОЕ ОСВЕЩЕНИЕ**

Taśmy LED
LED strips 526 – 531
Светодиодные ленты

Profile LED
LED profiles 532 – 563
Профили LED

Oprawy LED
LED fittings 563 – 573
Светодиодные светильники

Aksesoria
Accessories 574 – 601
Аксессуары

Przedłużacze biurkowe
Desk power sockets 602 – 623
Выдвижные удлинители

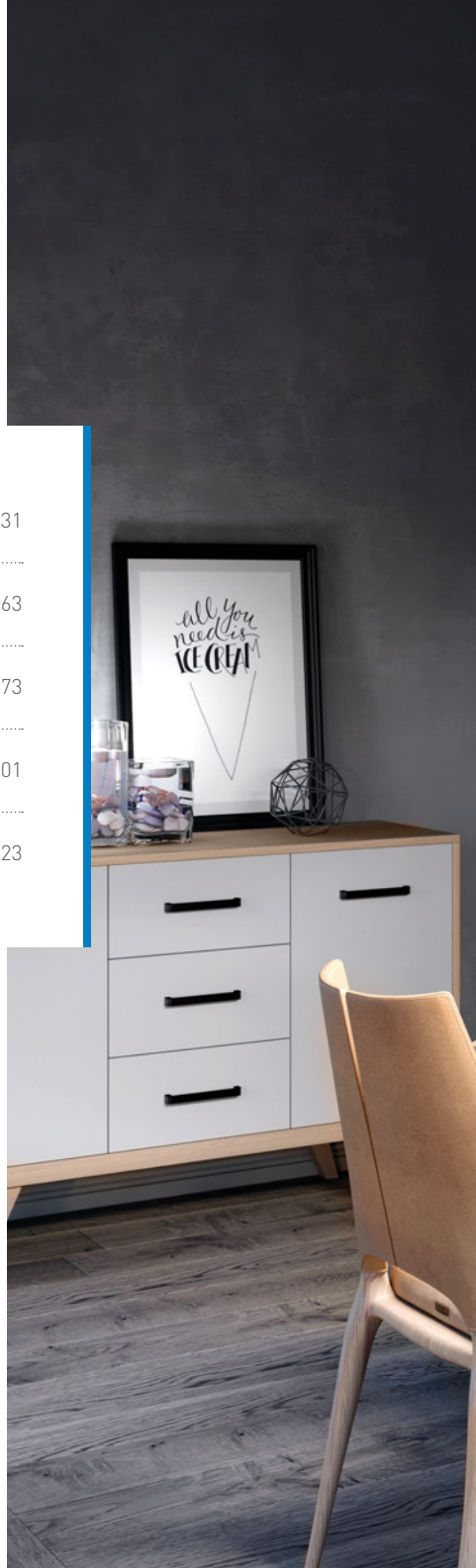





W 5-ciu krokach skompletuj zestaw EASY CLICK
Complete the EASY CLICK set in 5 steps
Завершите набор EASY CLICK за 5 шагов



1.

wybierz taśmę
select LED strip
выбрать светодиодную ленту

wybierz ilość odcinków taśm led
select the number of sections of LED strips
выбрать количество секций светодиодных лент

2.

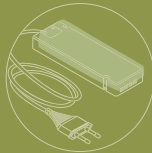

3.

dopasowany zasilacz
matched power supply
согласованный источник
питания

wybierz profil, profile sprzedawane są jako
gotowe 2 m zestawy, zawierające profil,
osłonkę i 2 zaślepki

select profile profiles are sold as ready
-made 2 m sets containing a profile,
a cover and 2 end caps

отдельные профили продаются в виде готовых
комплектов по 2 м, содержащих профиль,
крышку и 2 торцевые заглушки

4.

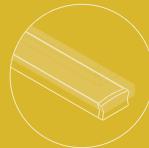

5.

wybierz włącznik
select a switch
выберите переключатель

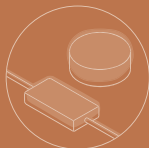

przed złożeniem
before mounting
перед монтажом

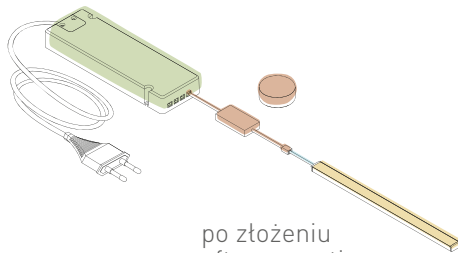

po złożeniu
after mounting
после монтажа

przykładowy schemat instalacji
sample installation diagram
примерная схема инсталляции

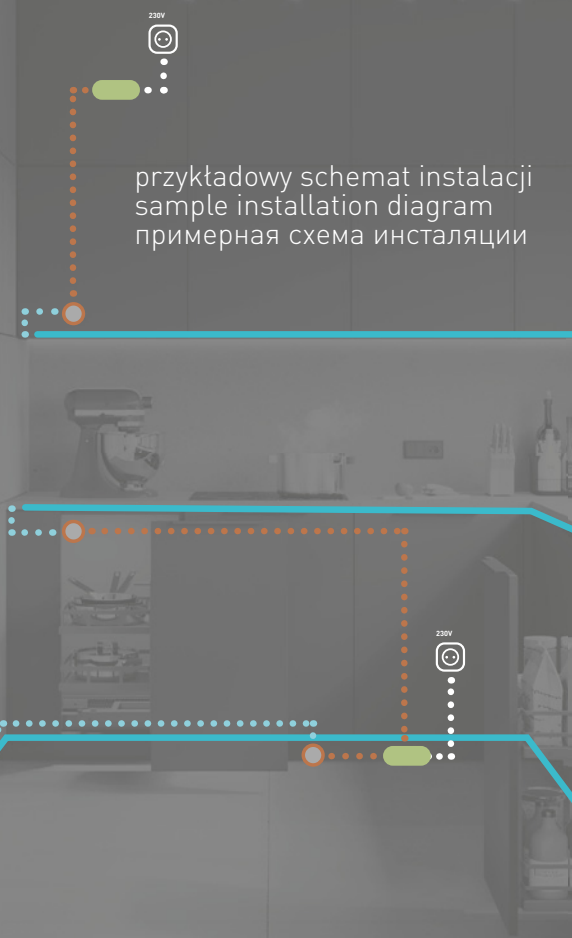

taśma led w profilu
LED strip in a profile
светодиодная лента в профиле

przewód od taśmy led
do wyłącznika
cable from LED strip to a switch

•••••
cable from LED strip to a switch
кабель от светодиодной ленты
к выключателю

przewody wyłącznika
switch cables
кабель выключателя

•••••
przewód od gniazda 230V
do zasilacza
cable from 230V mains
socket to LED driver
кабель от гнезда 230 В
для блока питания

•
wyłącznik
switch
выключатель

•
zasilacz
LED driver
блок питания

Taśma LED FLASH
LED strip FLASH
Светодиодная лента FLASH

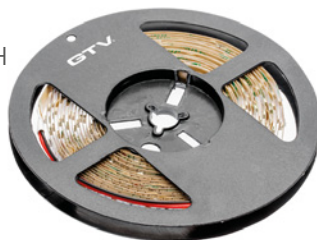

LD-3528-300-20-ZB	12 VDC 4,8 W/1 m 17 W/5 m	300 lm/m	● 6500 K	20	120°	60/m	5
LD-3528-300-20-NE4P			● 4000 K				
LD-3528-300-20-CB			● 3200 K				
LD-3528-300-65-ZB		280 lm/m	● 6500 K	65			
LD-3528-300-65-NE4			● 4000 K				
LD-3528-300-65-CB			● 3200 K				
LD-3528-300-20-NI	-	niebieski/ blue / синий					
LD-3528-600-20-ZB	12 VDC 9,6 W/1 m 28 W/5 m	550 lm/m	● 6500 K	20		120/m	2,5
LD-3528-600-20-NE4			● 4000 K				
LD-3528-600-20-CB			● 3200 K				
LD-3528-600-65-ZB		520 lm/m	● 6500 K	65			
LD-3528-600-65-NE4			● 4000 K				
LD-3528-600-65-CB			● 3200 K				
LD-2835-300-20-ZB	12 VDC 6 W/1 m 21 W/5 m	750 lm/m	● 6500 K	20	8	60/m	5
LD-2835-300-20-NE4P			● 4000 K				
LD-2835-300-20-CB			● 3200 K				
LD-2835-300-65-ZB		700 lm/m	● 6500 K	65			
LD-2835-300-65-NE4			● 4000 K				
LD-2835-300-65-CB			● 3200 K				
LD-2835-300-20-CBN	12 VDC 11 W/1 m 33 W/5 m	1000 lm/m	● 3200 K	20		120/m	2,5
LD-2835-300-20-ZBN			● 6500 K				
LD-2835-300-20-NE4N			● 4000 K				
LD-2835-300-65-CBN		900 lm/m	● 3200 K	65			
LD-2835-300-65-ZBN			● 6500 K				
LD-2835-300-65-NE4N			● 4000 K				
LD-2835-600-20-ZB	12 VDC 19 W/1 m 60 W/5 m	1600 lm/m	● 6500 K	20	10	120/m	2,5
LD-2835-600-20-NE4			● 4000 K				
LD-2835-600-20-CB			● 3200 K				
LD-2835-600-65-ZB		1350 lm/m	● 6500 K	65			
LD-2835-600-65-NE4			● 4000 K				
LD-2835-600-65-CB			● 3200 K				





LD-2835-600-5MM-20-ZB	12 VDC 10 W/1 m 33 W/5 m	750 lm/m	● 6500 K	20	120°	5	120/m	2,5
LD-2835-600-5MM-20-NE4			● 4000 K					
LD-2835-600-5MM-20-CB			● 3200 K					
LD-2835-60-60-20-CCT	12 VDC 10 W/1 m 30 W/5 m	700 lm/m	● 3200 K - ● 6500 K	20		8		5
LD-5050-300-20-ZB	12 VDC 14,4 W/1 m 44 W/5 m	900 lm/m	● 6500 K	65	120°	10	60/m	5
LD-5050-300-20-NE4			● 4000 K					
LD-5050-300-20-CB			● 3200 K					
LD-5050-300-65-ZB	12 VDC 16 W/1 m 50 W/5 m	850 lm/m	● 6500 K	20	120°	10	60/m	5
LD-5050-300-65-NE4			● 4000 K					
LD-5050-300-65-CB			● 3200 K					
LD-5630-300-20-ZB	12 VDC 16 W/1 m 50 W/5 m	1750 lm/m	● 6500 K	65	120°	10	60/m	5
LD-5630-300-20-NE4			● 4000 K					
LD-5630-300-20-CB			● 3200 K					
LD-5630-300-65-ZB	12 VDC 16 W/1 m 50 W/5 m	1700 lm/m	● 6500 K	20	120°	10	60/m	5
LD-5630-300-65-NE4			● 4000 K					
LD-5630-300-65-CB			● 3200 K					
LD-3014-1200-20-ZB	12 VDC 19 W/1 m 53 W/5 m	1300 lm/m	● 6500 K	65	120°	10	60/m	5
LD-3014-1200-20-NE4			● 4000 K					
LD-3014-1200-20-CB			● 3200 K					
LD-RGB-150-20	12 VDC max 7,2 W/1 m 22 W/5 m	-	● RGB	20	120°	10	30/m	10
LD-RGB-150-65			65					
LD-RGBW-300-20	12 VDC max 17 W/1 m	-	● RGBW	20	120°	10	60/m	5



ТаЅма LED FLASH 50 m
LED strip FLASH 50 m
Светоодиодная лента FLASH 50 m



LD-3528-300-20-ZB-50	12 VDC 4,8 W/m	300 lm/m	● 6500 K	20	120°	8 mm	60/m	5		
LD-3528-300-20-NE4P-50			● 4000 K							
LD-3528-300-20-CB-50			● 3200 K							
LD-3528-600-20-ZB-50	12 VDC 9,6 W/1 m	550 lm/m	● 6500 K				120/m			
LD-3528-600-20-NE4-50			● 4000 K							
LD-3528-600-20-CB-50			● 3200 K							
LD-2835-300-20-ZB-50	12 VDC 6 W/m	750 lm/m	● 6500 K			60/m				
LD-2835-300-20-NE4P-50			● 4000 K							
LD-2835-300-20-CB-50			● 3200 K							
LD-5050-300-20-NE4-50	12DC 14,4W/m	900 lm/m	● 4000 K	10 mm						
LD-5630-300-20-NE4-50	12DC 16W/m	1750 lm/m	● 4000 K							



ТаЅма LED FLASH
LED strip FLASH
Светоодиодная лента FLASH



LD-2835-24V-300-20-ZB	24 V DC 12 W/1 m 48 W/5 m	750 lm/m	● 6500 K	20	120°	8 mm	60/m	10		
LD-2835-24V-300-20-NE4			● 4000 K							
LD-2835-24V-300-20-CB			● 3200 K							
LD-2835-24V-600-20-ZB	24 V DC 21 W/1 m 78 W/5 m	1350 lm/m	● 6500 K			10 mm	120/m		5	
LD-2835-24V-600-20-NE4			● 4000 K							
LD-2835-24V-600-20-CB			● 3200 K							



Zestaw RGB, taśma LED 5 m, kontroler, zasilacz, pilot
 RGB-set, LED band 5 m, RGB controller, LED-transformator, remote control
 Комплект RGB, лента LED 5 м, контролер, трансформатор, пульт

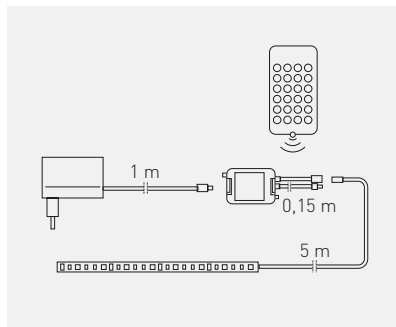

LD-ZL5RGB150-00	12V	RGB	tworzywo, plastic, пластик	10	10



ТаЅма LED COB
LED strip COB
Светодиодная лента COB

NEW



LD-COB12V-20-ZB	12 VDC 8,5 W/1 m 23 W/5 m	800 lm/m	5500 K	20	180°	8 mm	320/m	5
LD-COB12V-20-NE			4000 K					
LD-COB12V-20-CB			3200 K					



Taśma LED NEON FLEX
LED strip NEON FLEX
Светодиодная лента NEON FLEX



LD-NF-12V6x12-65-ZB	12 VDC 12 W/1 m 40 W/5 m	200 lm/m	● 6500 K	65	120°	6 mm	120/m	1	
LD-NF-12V6x12-65-NE			● 4000 K						
LD-NF-12V6x12-65-CB			● 3000 K						
LD-ZASNF-12V6X12-65	zaślepka, end cap, заглушка								
LD-UNF-12V6X12-6X	uchwyt, mounting clip, держатель								



LD-ZASNF-12V6X12-65



LD-UNF-12V6X12-6X

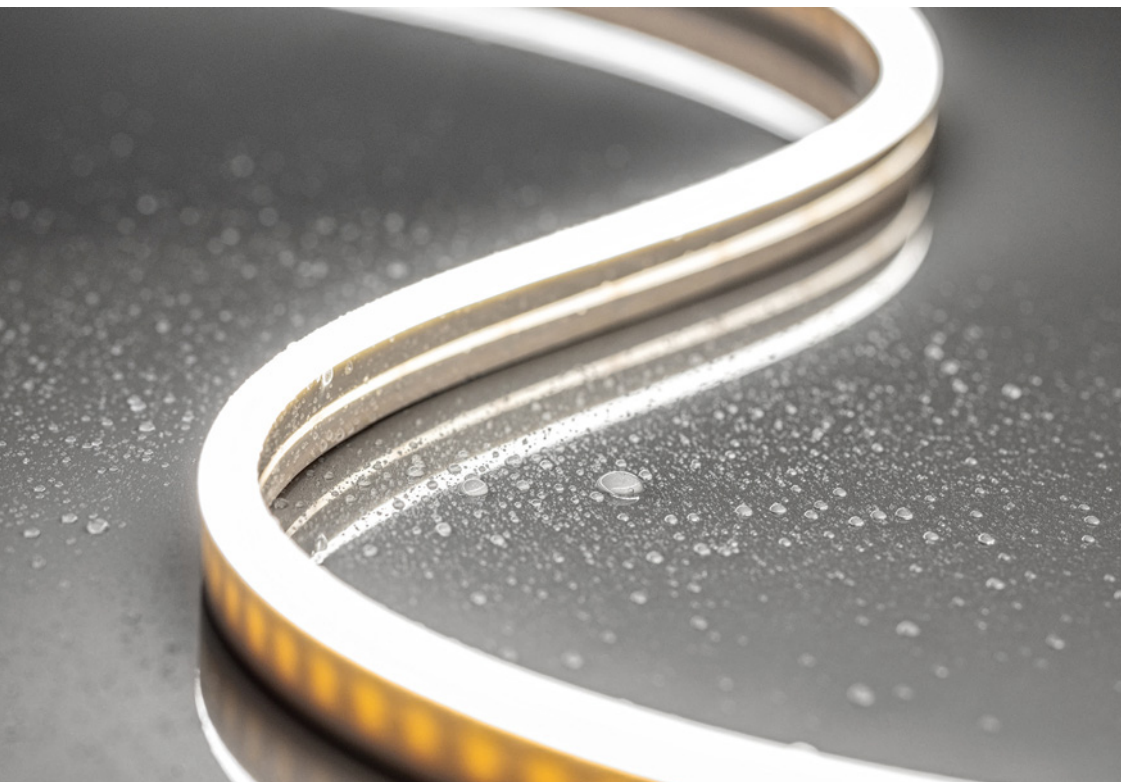

Profil GLAX liniowy
GLAX linear profile
Профиль GLAX линейный

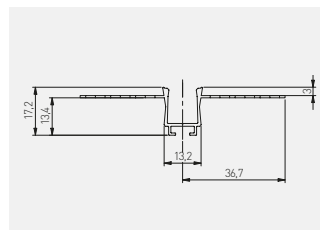
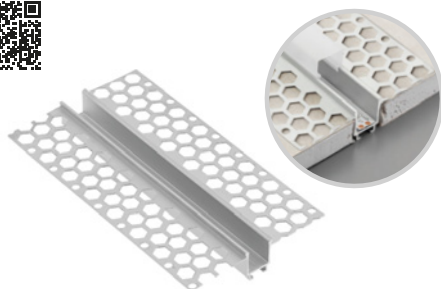

PA-GLAXGKL3M-00C	3	profil / profile / профиль	srebrny silver серебристый	aluminium aluminium алюминий
PA-CPGLAXL-00	-	łącznik liniowy connector straight лінійний з'єднувач		stal nierdzewna stainless steel нержавеющая сталь
PA-CPGLAXAH-00	-	łącznik poziomy connector horizontal горизонтальний з'єднувач		
PA-CPGLAXAV-00	-	łącznik pionowy connector vertical вертикальний з'єднувач		
PA-OSMLGLAXM3M-00	3	ostonka / cover / крышка	mleczna frosted молочная	PC
PA-OSMLGLAXMK3M-00	3	ostonka kwadratowa cover square крышка квадратная		
PA-OSMLGLAXM03M-00	3	ostonka okrągła cover round крышка круглая		
PA-OSMLGLAXT3M-00	3	ostonka trójkątna cover triangular крышка треугольная		

Ostonki / Covers / Крышки



PA-OSMLGLAXM3M-00 PA-OSMLGLAXMK3M-00 PA-OSMLGLAXM03M-00 PA-OSMLGLAXT3M-00

Aksesoria / Accessories / Аксессуары



PA-CPGLAXL-00 PA-CPGLAXAH-00 PA-CPGLAXAV-00



Profil GLAX ścienny
GLAX wall profile
Профиль GLAX настенный

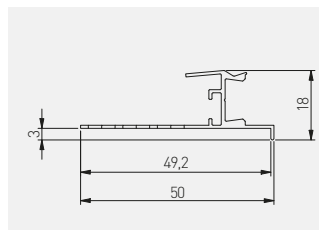
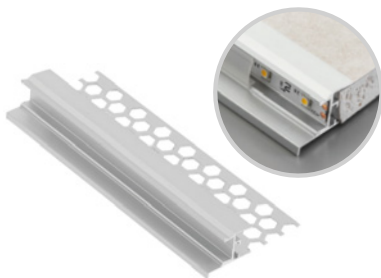

PA-GLAXGKS3M-00C	3	profil / profile / профиль	srebrny silver серебристый	aluminium aluminium алюминий
PA-CPGLAXL-00	-	łącznik liniowy connector straight лінійний з'єднувач		stal nierdzewna stainless steel нержавеющая сталь
PA-CPGLAXAH-00	-	łącznik poziomy connector horizontal горизонтальный з'єднувач		
PA-CPGLAXAV-00	-	łącznik pionowy connector vertical вертикальний з'єднувач		
PA-OSMLGLAXM3M-00	3	ostonka / cover / крышка	mleczna frosted молочная	PC
PA-OSMLGLAXMK3M-00	3	ostonka kwadratowa cover square крышка квадратная		
PA-OSMLGLAXM03M-00	3	ostonka okrągła cover round крышка круглая.		
PA-OSMLGLAXT3M-00	3	ostonka trójkątna cover triangular крышка треугольная		

Ostonki / Covers / Крышки



PA-OSMLGLAXM3M-00 PA-OSMLGLAXMK3M-00 PA-OSMLGLAXM03M-00 PA-OSMLGLAXT3M-00

Aksesoria / Accessories / Аксессуары



PA-CPGLAXL-00 PA-CPGLAXAH-00 PA-CPGLAXAV-00



DO
something
(today)
THAT YOUR
FUTURE SELF
WILL
THANK YOU
for

BE
BRAVE

Better
days are
coming.
They're
called
Saturday and
Sunday.

Smile
you
are
beaut-
iful.

the
time
is
now.

DO
WHAT
YOU
LOVE.♥

A
you
is
BRA

Profil GLAX sufitowy
GLAX ceiling profile
Профиль GLAX потолочный

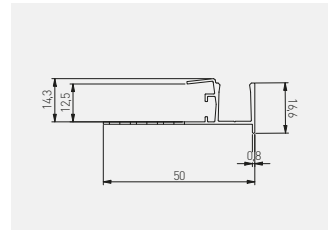
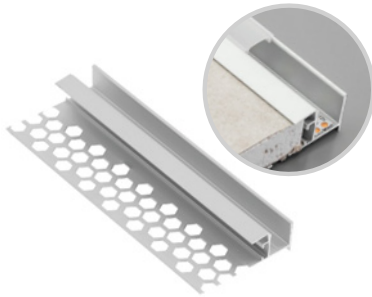

PA-GLAXGKW3M-00C	3	profil / profile / профиль	srebrny silver серебристый	aluminium aluminium алюминий
PA-CPGLAXL-00	-	łącznik liniowy connector straight лінійний з'єднувач		stal nierdzewna stainless steel нержавеющая сталь
PA-CPGLAXAH-00	-	łącznik poziomy connector horizontal горизонтальний з'єднувач		
PA-CPGLAXAV-00	-	łącznik pionowy connector vertical вертикальний з'єднувач		
PA-OSMLGLAXM3M-00	3	osłonka / cover / крышка	mleczna frosted молочная	PC
PA-OSMLGLAXMK3M-00	3	osłonka kwadratowa cover square крышка квадратная		
PA-OSMLGLAXM03M-00	3	osłonka okrągła cover round крышка круглая		
PA-OSMLGLAXT3M-00	3	osłonka trójkątna cover triangular крышка треугольная		

Ostonki / Covers / Крышки



PA-OSMLGLAXM3M-00 PA-OSMLGLAXMK3M-00 PA-OSMLGLAXM03M-00 PA-OSMLGLAXT3M-00

Aksesoria / Accessories / Аксессуары



PA-CPGLAXL-00 PA-CPGLAXAH-00 PA-CPGLAXAV-00



Profil GLAX kątowy, wewnętrzny
GLAX internal angle profile
Профиль GLAX угловой внутренний

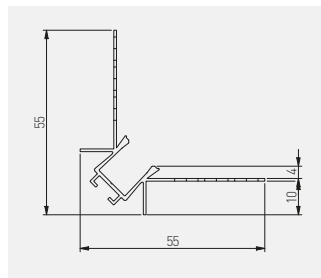

PA-GLAXGKWK3M-00C	3	profil / profile / профиль	srebrny silver серебристый	aluminium aluminium алюминий
PA-CPGLAXL-00	-	łącznik liniowy connector straight лінійний з'єднувач		stal nierdzewna stainless steel нержавеющая сталь
PA-CPGLAXAH-00	-	łącznik poziomy connector horizontal горизонтальний з'єднувач		
PA-CPGLAXAV-00	-	łącznik pionowy connector vertical вертикальний з'єднувач		
PA-OSMLGLAXM3M-00	3	ostonka / cover / крышка	mleczna frosted молочная	PC
PA-OSMLGLAXMK3M-00	3	ostonka kwadratowa cover square крышка квадратная		
PA-OSMLGLAXM03M-00	3	ostonka okrągła cover round крышка круглая		
PA-OSMLGLAXT3M-00	3	ostonka trójkątna cover triangular крышка треугольная		

Ostonki / Covers / Крышки



PA-OSMLGLAXM3M-00 PA-OSMLGLAXMK3M-00 PA-OSMLGLAXM03M-00 PA-OSMLGLAXT3M-00

Aksesoria / Accessories / Аксессуары



PA-CPGLAXL-00 PA-CPGLAXAH-00 PA-CPGLAXAV-00



Profil GLAX kątowy, zewnętrzny
GLAX external angle profile
Профиль GLAX угловой внешний

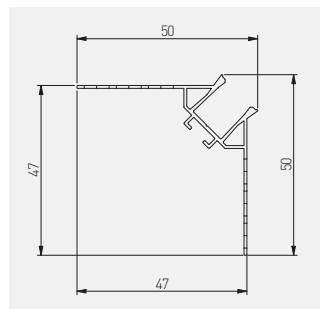
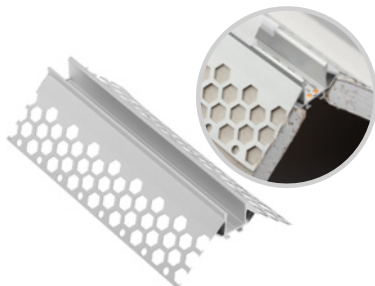

PA-GLAXGKZK3M-00C	3	profil / profile / профиль		aluminium aluminium алюминий	
PA-CPGLAXL-00	-	łącznik liniowy connector straight лінійний з'єднувач		srebrny silver серебристый	stal nierdzewna stainless steel нержавеющая сталь
PA-CPGLAXAH-00	-	łącznik poziomy connector horizontal горизонтальный з'єднувач			
PA-CPGLAXAV-00	-	łącznik pionowy connector vertical вертикальний з'єднувач			
PA-OSMLGLAXM3M-00	3	ostonka / cover / крышка		PC	
PA-OSMLGLAXMK3M-00	3	ostonka kwadratowa cover square крышка квадратная			
PA-OSMLGLAXM03M-00	3	ostonka okrągła cover round крышка круглая			
PA-OSMLGLAXT3M-00	3	ostonka trójkątna cover triangular крышка треугольная			

Ostonki / Covers / Крышки



PA-OSMLGLAXM3M-00 PA-OSMLGLAXMK3M-00 PA-OSMLGLAXM03M-00 PA-OSMLGLAXT3M-00

Aksesoria / Accessories / Аксессуары



PA-CPGLAXL-00 PA-CPGLAXAH-00 PA-CPGLAXAV-00

Profil GLAX nakładany, mikro
 GLAX profile surface mounted, micro
 Профиль GLAX накладной, микро

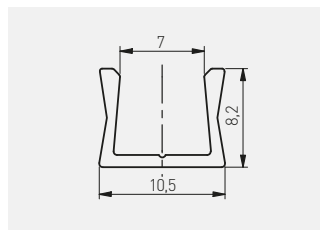
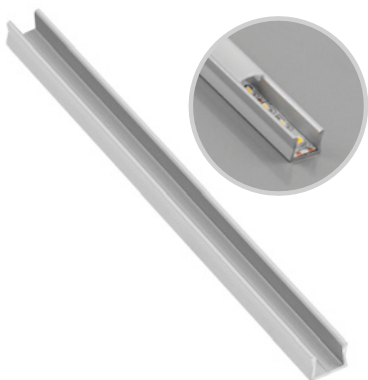

Wąska linia światła.
 Brak punktów świetlnych przy użyciu
 dedykowanej taśmy LED o szerokości 5 mm.
 Narrow line of light.
 No visible points of light due to dedicated
 5mm LED strip.
 Узкая линия света.
 Отсутствуют пункты свечения при
 использовании специальной ленты LED
 с шириной 5 мм.

PA-GLAXMICNK-AL	2	profil profile профиль	srebrny silver серебристый	aluminium aluminium алюминий
PA-GLAXMICNK3M-AL	3			
PA-OSMLGLAXMIC-00N	2	ostonka mikro cover micro крышка микро	mleczna frosted молочная	PC
PA-OSMLGLAXMIC3M-00N	3			
PA-ZASGLAXMICNK-00	-	zaślepka end cap заглушка	szary gray серый	ABS
PA-SPRGLAXMIC-00	-	uchwyt mounting clip держатель	srebrny silver серебристый	stal nierdzewna stainless steel нержавеющая сталь



Profil GLAX nakładany mini
GLAX profile mini surface mounted
Профиль GLAX накладной мини

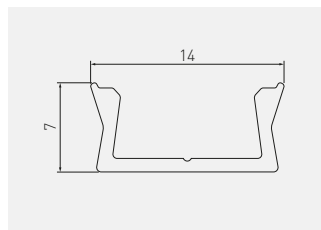
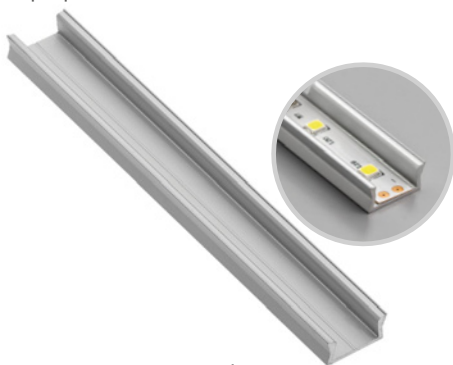

Taśma LED max. 10 mm szerokości
LED strip width max 10 mm
Ширина светодиодной ленты не более 10 мм



PA-GLAXMNK-AL	2	profil profile профиль	srebrny / silver / серебристый	aluminium aluminium алюминий
PA-GLAXMNK-AL-20M			czarny / black / черный	
PA-GLAXMNK-AL-10			biały / white / белый	
PA-GLAXMNK-AL-90			szampan / champagne / шампань	
PA-GLAXMNK3M-AL			srebrny / silver / серебристый	
PA-GLAXMNK3M-AL-20M			czarny / black / черный	
PA-GLAXMNK3M-AL-10	3	biały / white / белый		
PA-OSMLGLAXM-00	2	ostonka mini cover mini крышка мини	mleczna / frosted / молочная	PC
PA-OSMLGLAXM3M-00	3		transparentna / transparent прозрачная	
PA-OSTRGLAXM-00	2			
PA-OSTRGLAXM3M-00	3			
PA-OSMLGLAXMK-00	2	ostonka kwadratowa cover square крышка квадратная	mleczna / frosted / молочная	
PA-OSMLGLAXMO-00		ostonka okrągła cover round крышка круглая		
PA-ZASGLAXMNK-00	-	zaślepka standard end cap standard заглушка стандартная	szary / gray / серый	ABS
PA-ZASGLAXMNK-10			biały / white / белый	
PA-ZASGLAXMNK-90			szampan / champagne / шампань	
PA-ZASGLAXMNK-20M			czarny mat / black matt / чёрный матовый	
PA-ZASGLAXMNKK-00	-	zaślepka kwadratowa end cap square заглушка квадратная	szary / gray / серый	
PA-ZASGLAXMNKO-00	-	zaślepka okrągła end cap round заглушка круглая	szary / gray / серый	
PA-SPRGLAXM-00	-	uchwyt mounting clip держатель	srebrny / silver / серебристый	stal nierdzewna stainless steel нержавеющая сталь

Ostonki / Covers / Крышки

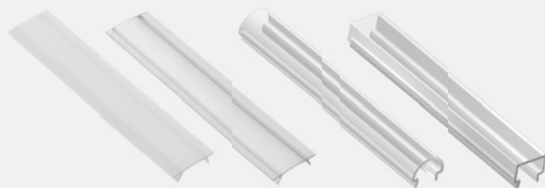

PA-OSMLGLAXM-00
PA-OSMLGLAXM3M-00

PA-OSTRGLAXM-00
PA-OSTRGLAXM3M-00

PA-OSMLGLAXMO-00

PA-OSMLGLAXMK-00

Zaślepki / End caps / Заглушки



PA-ZASGLAXMNK-00

PA-ZASGLAXMNKK-00

Uchwyt
mounting clip
держатель

PA-ZASGLAXMNKO-00

PA-SPRGLAXM-00

Profil GLAX nakładany
GLAX profile surface mounted
Профиль GLAX накладной

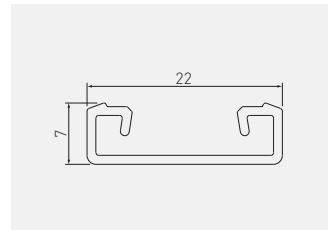

PA-GLAXNK-AL	2	profil profile профиль	srebrny silver серебристый	aluminium aluminium алюминий
PA-GLAXNK3M-AL	3			
PA-OSMLGLAX-00	2	osłonka mini cover mini крышка мини	mleczna frosted молочная	PC
PA-OSMLGLAX3M-00	3			
PA-OSTRGLAX-00	2		transparentna transparent прозрачная	
PA-OSTRGLAX3M-00	3			
PA-ZASGLAXNK-00	-	zaślepka end cap заглушка	szary gray серый	ABS



Profil GLAX nakładany mini, wysoki
 Profile GLAX surface mounted mini, high
 Профиль GLAX накладной мини, высокий

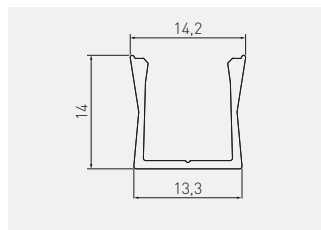

Brak widocznych punktów świetlnych.
 Taśma LED max 10 mm szerokości.
 No visible points of light.
 LED strip width max 10 mm.
 Нет видимых точек света.
 Ширина светодиодной ленты не более 10 мм.



PA-GLAXMNKW-AL	2	profil profile профиль	srebrny / silver / серебристый	aluminium aluminium алюминий
PA-GLAXMNKW-AL-20M			czarny / black / черный	
PA-GLAXMNKW-AL-10			biały / white / белый	
PA-GLAXMNKW-AL-90			szampań / champagne / шампань	
PA-OSMLGLAXM-00	2	ostonka mini cover mini крышка мини	mleczna / frosted / молочная	PC
PA-OSTRGLAXM-00			transparentna / transparent / прозрачная	
PA-ZASGLAXMNKW-00	-	zaślepka end cap заглушка	szary / gray / серый	ABS
PA-ZASGLAXMNKW-10			biały / white / белый	
PA-ZASGLAXMNKW-90			szampań / champagne / шампань	
PA-ZASGLAXMNKW-20M			czarny mat / black matt / чёрный матовый	
PA-SPRGLAXM-00	-	uchwyt mounting clip держатель	srebrny / silver / серебристый	stal nierdzewna stainless steel нержавеющая сталь

Ostonki / Covers / Крышки



PA-OSMLGLAXM-00



PA-OSTRGLAXM-00

Zaślepka / End cap / Заглушка



PA-ZASGLAXMNKW-00

 Uchwyt
Mounting clip
держатель

PA-SPRGLAXM-00

Profil GLAX wpuszczany, mikro
GLAX profile recessed, micro
Профиль GLAX врезной, микро

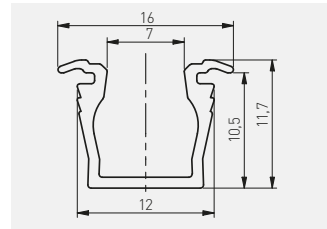
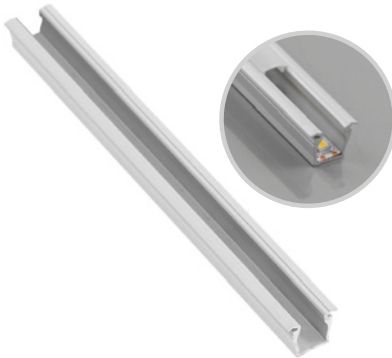

Wąska linia światła.
Brak punktów świetlnych przy użyciu dedykowanej taśmy LED o szerokości 5 mm.
Narrow line of light.
No visible points of light due to dedicated 5 mm LED strip.
Узкая линия света.
Отсутствуют пункты свечения при использовании специальной ленты LED с шириной 5 мм.

PA-GLAXMIC-AL	2	profil profile профиль	srebrny silver серебристый	aluminium aluminium алюминий
PA-GLAXMIC3M-AL	3			
PA-OSMLGLAXMIC-00N	2	ostonka mikro cover micro крышка микро	mleczna frosted молочная	PC
PA-OSMLGLAXMIC3M-00N	3			
PA-ZASGLAXMIC-00	-	zaślepka end cap заглушка	szary gray серый	ABS

Ostonki / Covers / Крышки



PA-OSMLGLAXMIC-00N
PA-OSMLGLAXMIC3M-00N

Zaślepka / End cap / Заглушка



PA-ZASGLAXMIC-00

Profil GLAX wpuszczany
Profile GLAX recessed
Профиль LED GLAX врезной

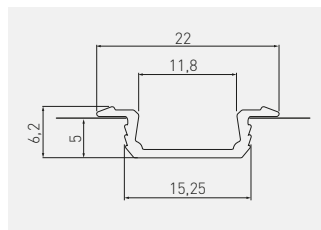

PA-GLAX-AL	2	profil profile профиль	srebrny / silver / серебристый	aluminium aluminium алюминий
PA-GLAX-AL-20M			czarny / black / черный	
PA-GLAX-AL-10			biały / white / белый	
PA-GLAX-AL-90			szampan / champagne / шампань	
PA-GLAX3M-AL			srebrny / silver / серебристый	
PA-GLAX3M-AL-20M	3		czarny / black / черный	
PA-GLAX3M-AL-10			biały / white / белый	
PA-OSMLGLAX-00	2	ostonka cover крышка	mleczna frosted молочная	PC
PA-OSMLGLAX3M-00	3		transparentna transparent прозрачная	
PA-OSTRGLAX-00	2			
PA-OSTRGLAX3M-00	3			
PA-ZASGLAX-00	-	zaślepka end cap заглушка	szary / gray / серый	ABS
PA-ZASGLAX-10			biały / white / белый	
PA-ZASGLAX-90			szampan / champagne / шампань	
PA-ZASGLAX-20M			czarny mat / black matt / чёрный матовый	

Ostonki / Covers / Крышки

Zaślepka / End cap / Заглушка



PA-ZASGLAX-00

PA-OSMLGLAX-00
PA-OSMLGLAX3M-00

PA-OSTRGLAX-00
PA-OSTRGLAX3M-00

Profil GLAX wpuszczany, wysoki
 Profile GLAX recessed, high
 Профиль LED GLAX врезной

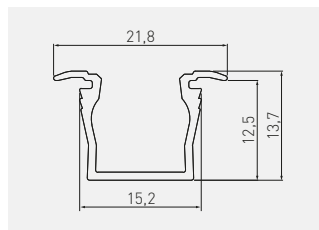

Brak widocznych punktów świetlnych.
 Taśma LED max. 10 mm szerokości.

No visible points of light.
 LED strip width max 10 mm.

Нет видимых точек света.
 Ширина светодиодной ленты
 не более 10 мм.

PA-GLAXMW-AL	2	profil profile профиль	srebrny / silver / серебристый	aluminium aluminium алюминий	
PA-GLAXMW-AL-20M			czarny / black / черный		
PA-GLAXMW-AL-10			biały / white / белый		
PA-GLAXMW-AL-90			szampan / champagne / шампань		
PA-OSMLGLAXM-00	2	ostonka mini cover mini крышка мини	mleczna frosted молочная	PC	
PA-OSMLGLAXMK-00		ostonka kwadratowa cover square крышка квадратная			
PA-OSTRGLAXM-00		ostonka mini cover mini крышка мини			
PA-ZASGLAXMW-00	-	zaślepka standard end cap standard заглушка стандартная	szary / gray / серый	ABS	
PA-ZASGLAXMW-10			biały / white / белый		
PA-ZASGLAXMW-90			szampan / champagne / шампань		
PA-ZASGLAXMW-20M			czarny mat / black matt / чёрный матовый		
PA-ZASGLAXMWK-00	-	zaślepka kwadratowa end cap square заглушка квадратная	szary / gray / серый		

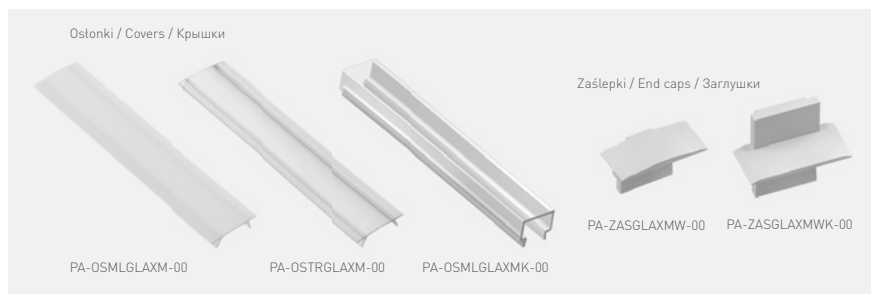

Profil GLAX drążkowy
GLAX rail profile
Профиль-штанга GLAX

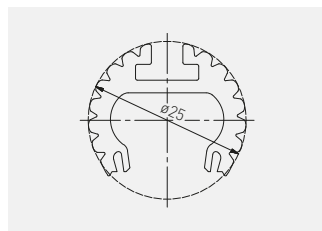

Możliwości montażu jako:

Assembly options as:

Варианты сборки:

- drążek w szafie
- rod in the closet
- стержень в шкафу
- oprawa zwieszana
- suspended luminaire
- подвесной светильник

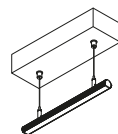
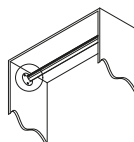

PA-GLAXDR-AL		profil profile профиль	srebrny silver серебристый	aluminium aluminium алюминий
PA-OSMLGLAX-00	2	ostonka cover крышка	mleczna frosted молочная	PC
PA-OSTRGLAX-00			transparentna transparent прозрачная	
PA-ZASGLAXDR-00	-	zaślepka end cap заглушка	szary gray серый	ABS
PA-ROZGLAX-53	-	rozetka rail socket монтажный крепеж		ZnAl
PA-ROZGLAXP-53	-	rozetka PREMIUM rail socket PREMIUM монтажный крепеж PREMIUM		
PA-ZAWGLAXDR-00	1,5	zawieszka hanger подвес для профиля	chrom chrome хром	stal steel сталь

Ostonki / Covers / Крышки

Zaślepka / End cap /
Заглушка

Rozetka / Rail socket /
Монтажный крепеж

Zawieszka / Hanger /
Подвес для профиля



PA-OSMLGLAX-00

PA-OSTRGLAX-00

PA-ZASGLAXDR-00

PA-ROZGLAX-53

PA-ROZGLAXP-53

PA-ZAWGLAXDR-00

Profil GLAX z radiatorem
 Profile GLAX with heatsink
 Профиль GLAX с радиатором

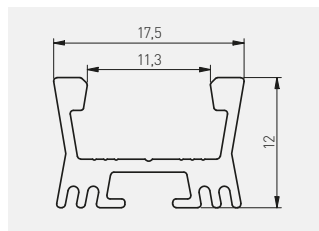

Dedykowana soczewka zawężająca kąt świecenia do 60°.

Możliwość zawieszenia oprawy za pomocą linek.
 Dedicated lens that narrow the beam angle to 60°.
 Possibility to suspend the fixture using lines.

Специальная линза, сужающая угол свечения до 60°.
 Возможность монтажа с помощью крепления-тросика.

PA-GLAXRAD-AL	2	profil / profile / профиль	srebrny silver серебристый	aluminium aluminium алюминий
PA-OSMLGLAXSO-00	2	osłonka soczewka cover lenticular крышка линзовидный	transparentna transparent прозрачная	PMMA
PA-OSMLGLAX-00	2	osłonka cover крышка	mleczna frosted молочная	PC
PA-OSTRGLAX-00			transparentna transparent прозрачная	
PA-ZASGLAXRAD-00	-	zaślepka end cap заглушка	szary / gray / серый	ABS
PA-ZAWGLAXDR-00	1,5	zawieszka hanger подвес для профиля	chrom chrome хром	stal nierdzewna stainless steel нержавеющая сталь
PA-SPRGLAXM-00	-	uchwyt mounting clip держатель	srebrny / silver / серебристый	



Profil GLAX wieńcowy
Rim profile GLAX
Профиль GLAX, торцевой

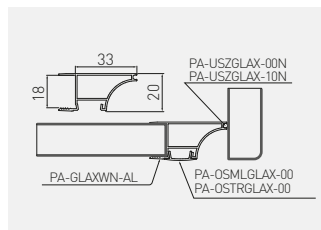
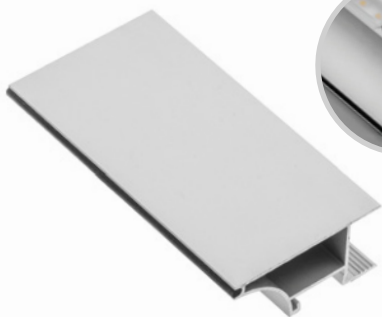

PA-GLAXWN-AL	18	2	profil profile профиль	srebrny, silver, серебристый	aluminium, aluminium, алюминий
PA-GLAXWN3M-AL		3		czarny, black, черный	
PA-GLAXWN3M-AL-20M				biały, white, белый	
PA-GLAXWN3M-AL-10				inox, inox, шлифованная сталь.	
PA-GLAXWN3M-AL-06				2	
PA-GLAXWN16-AL	16	2	ostonka cover крышка		mleczna, frosted, молочная
PA-GLAXWN19-AL	19			transparentna, transparent, прозрачная	
PA-OSMLGLAX-00	-	2	3	mleczna, frosted, молочная	
PA-OSTRGLAX-00				transparentna, transparent, прозрачная	
PA-OSMLGLAX3M-00	-	3	3	mleczna, frosted, молочная	EPDM
PA-OSTRGLAX3M-00	-			transparentna, transparent, прозрачная	
PA-USZGLAX-00N	-	10	uszczelka cord gasket уплотнитель	czarny, black, черный	
PA-USZGLAX-10N				biały, white, белый	

Ostonki / Covers / Крышки

Uszczelka / Cord gasket / Уплотнитель



PA-OSMLGLAX-00



PA-OSTRGLAX-00



ø2,5

PA-USZGLAX-00N



ø2,5

PA-USZGLAX-10N

Profil GLAX kątowy, nakładany
 GLAX aluminium corner profile – surface mounted
 Профиль LED GLAX угловой, накладной

meble
 2019 plus
 PRODUKT ROKU

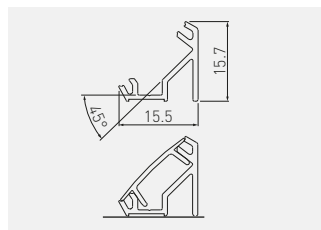
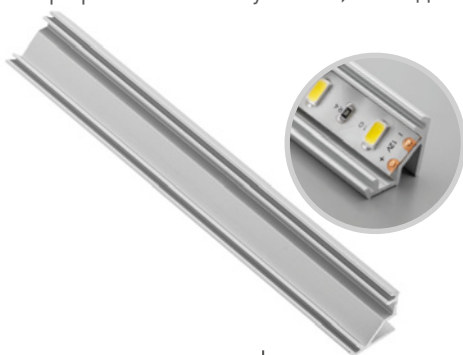

PA-GLAXNKKT-AL	2	profil profile профиль	srebrny / silver / серебристый	aluminium aluminium алюминий	
PA-GLAXNKKT-AL-20M			czarny / black / черный		
PA-GLAXNKKT-AL-10			biały / white / белый		
PA-GLAXNKKT-AL-90			szampan / champagne / шампань		
PA-GLAXNKKT3M-AL			srebrny / silver / серебристый		
PA-GLAXNKKT3M-AL-20M			czarny / black / черный		
PA-GLAXNKKT3M-AL-10	3	biały / white / белый			
PA-OSMLGLAX-00	2	osłonka cover крышка	mleczna frosted молочная	PC	
PA-OSMLGLAX3M-00	3		transparentna transparent прозрачная		
PA-OSTRGLAX-00	2				
PA-OSTRGLAX3M-00	3				
PA-OSMLGLAXT-00	2	osłonka trójkątna cover triangular крышка треугольная	mleczna frosted молочная		
PA-ZASGLAXNKKT-00	-	zaślepka standard end cap standard заглушка стандартная	szary / gray / серый	ABS	
PA-ZASGLAXNKKT-10			biały / white / белый		
PA-ZASGLAXNKKT-90			szampan / champagne / шампань		
PA-ZASGLAXNKKT-20M			czarny mat / black matt / чёрный матовый		
PA-ZASGLAXNKKTT-00		zaślepka trójkątna end cap triangular заглушка треугольная	szary / gray / серый		
PA-SPRGLAXMIC-00	-	uchwyt mounting clip держатель	srebrny / silver / серебристый	stal nierdzewna stainless steel нержавеющая сталь	

Ostonki / Covers / Крышки

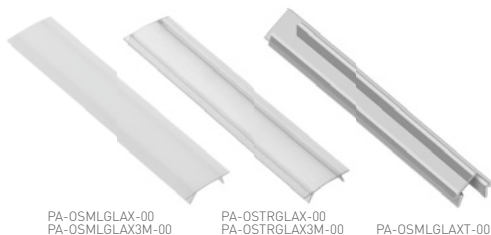





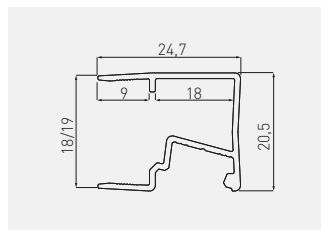

Zaślepki / End caps / Заглушки



Profil GLAX cokołowy wąski, jednostronny
 Corner profile GLAX, one-sided, edge mounted
 Профиль GLAX торцевой, узкий, накладной, односторонний



								
PA-GLAXMNBW3M-AL	18	3	profil profile профиль	srebrny silver серебристый	aluminium aluminium алюминий			
PA-GLAXMNBW3M19-AL	19							
PA-OSMLGLAXM3M-00	-					ostonka mini cover mini крышка мини	mleczna frosted молочная	PC
PA-OSTRGLAXM3M-00	-						transparentna transparent прозрачная	

Ostonki / Covers / Крышки



PA-OSMLGLAXM3M-00



PA-OSTRGLAXM3M-00

Profil GLAX cokołowy wąski, dwustronny
 Corner profile GLAX, two-sided, edge mounted
 Профиль GLAX торцевой, узкий, накладной, двусторонний

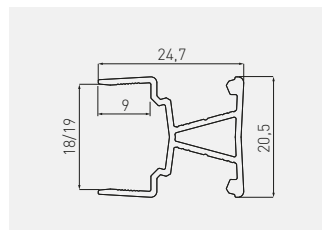
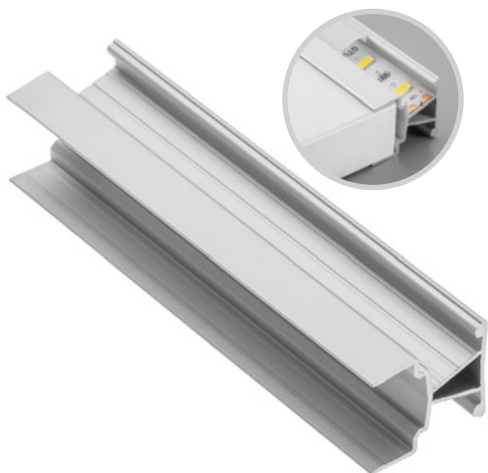

PA-GLAXMNBW3M-AL	18	3	profil profile профиль	srebrny silver серебристый	aluminium aluminium алюминий
PA-GLAXMNBW3M19-AL	19				
PA-OSMLGLAXM3M-00	-		ostonka mini cover mini крышка мини	mleczna frosted молочная	PC
PA-OSTRGLAXM3M-00	-			transparentna transparent прозрачная	

Ostonki / Covers / Крышки



PA-OSMLGLAXM3M-00







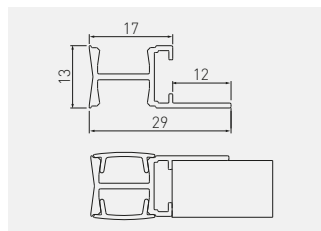
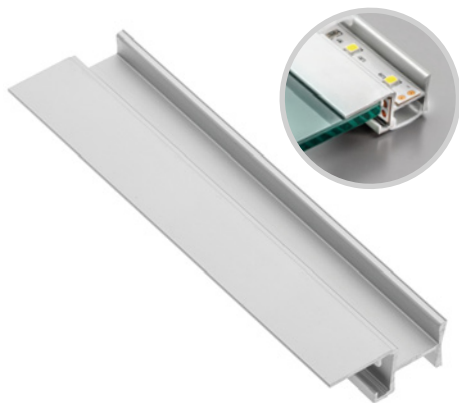

PA-OSTRGLAXM3M-00

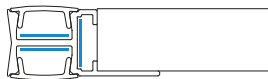
Profil GLAX półkowy mini
Shelf profile GLAX mini
Профиль GLAX полочный мини



Możliwość zastosowania 3 taśm LED.
Possibility of using 3 LED strips.
Возможность использования 3 светодиодных лент.



	 L m			
PA-GLAXMPK-AL	2	profil profile профиль	srebrny silver серебристый	aluminium aluminium алюминий
PA-OSMLGLAXM-00		ostonka mini cover mini крышка мини	mleczna frosted молочная	PC
PA-OSTRGLAXM-00		transparentna transparent прозрачная		

Ostonki / Covers / Крышки









PA-OSMLGLAXM-00

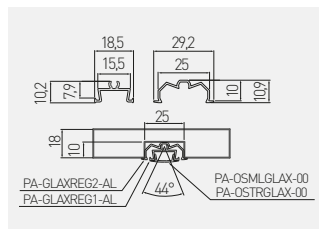

PA-OSTRGLAXM-00

Profil GLAX z regulowanym kątem świecenia
 Aluminium Profile LED with adjustable angle
 Профиль LED GLAX с регулировкой угла свечения



	 L m			
PA-GLAXREG1-AL	2	profil profile профиль	srebrny silver серебристый	aluminium aluminium алюминий
PA-GLAXREG2-AL				
PA-OSMLGLAX-00	2	ostonka cover крышка	mleczna frosted молочная	PC
PA-OSTRGLAX-00			transparentna transparent прозрачная	

Ostonki / Covers / Крышки



PA-OSMLGLAX-00



PA-OSTRGLAX-00

Profil GLAX cokołowy jednostronny
 GLAX aluminium edge profile – single-sided
 Профиль LED GLAX торцевой, односторонний

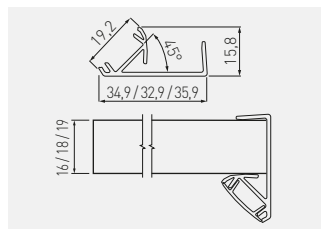

PA-GLAXNBJ3M16-AL	16	3	profil profile профиль	srebrny silver серебристый	aluminium aluminium алюминий
PA-GLAXNBJ3M-AL	18	3			
PA-GLAXNBJ3M19-AL	19	3			
PA-OSMLGLAX3M-00	-	3	ostonka cover крышка	mleczna frosted молочная	PC
PA-OSTRGLAX3M-00	-	3		transparentna transparent прозрачная	

Ostonki / Covers / Крышки



PA-OSMLGLAX3M-00



PA-OSTRGLAX3M-00

Profil GLAX cokołowy jednostronny, do wypełnienia obrzeżem
 GLAX aluminium edge profile – single-sided, option to fill with matching edge banding
 Профиль LED GLAX торцевой, односторонний, кромочный, двухсторонний

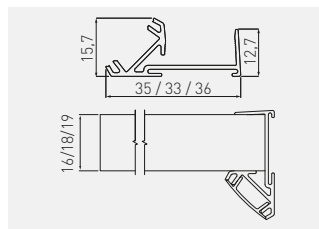

	 BOARD mm	 L mm m			
PA-GLAXNB JW3M16-AL	16	3	profil profile профиль	srebrny silver серебристый	aluminium aluminium алюминий
PA-GLAXNB JW3M-AL	18	3			
PA-GLAXNB JW3M19-AL	19	3			
PA-OSMLGLAX3M-00	-	3	ostonka cover крышка	mleczna frosted молочная	PC
PA-OSTRGLAX3M-00	-	3		transparentna transparent прозрачная	

Ostonki / Covers / Крышки



PA-OSMLGLAX3M-00



PA-OSTRGLAX3M-00

Profil GLAX przegrodowy dwustronny
 GLAX aluminium edge profile – double sided
 Профиль LED GLAX разделительный, двухсторонний

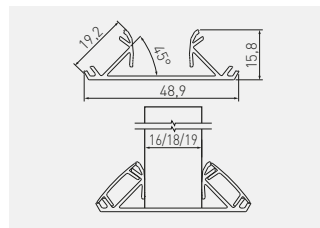

	BOARD mm	L m			
PA-GLAXNBD3M16-AL	16	3	profil profile профиль	srebrny silver серебристый	aluminium aluminium алюминий
PA-GLAXNBD3M-AL	18	3			
PA-GLAXNBD3M19-AL	19	3			
PA-OSMLGLAX3M-00	-	3	ostonka cover крышка	mleczna frosted молочная	PC
PA-OSTRGLAX3M-00	-	3		transparentna transparent прозрачная	

Ostonki / Covers / Крышки



PA-OSMLGLAX3M-00



PA-OSTRGLAX3M-00

Profil GLAX przegrodowy dwustronny, do wypełnienia obrzeżem
 GLAX aluminium edge profile – double sided, option to fill with matching edge banding
 Профиль LED GLAX разделительный, кромочный, двухсторонний

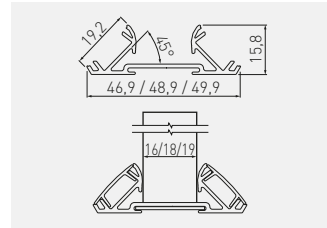

	 BOARD mm	 L m			
PA-GLAXNBDW3M16-AL	16	3	profil profile профиль	srebrny silver серебристый	aluminium aluminium алюминий
PA-GLAXNBDW3M-AL	18	3			
PA-GLAXNBDW3M19-AL	19	3			
PA-OSMLGLAX3M-00	-	3	ostonka cover крышка	mleczna frosted молочная	PC
PA-OSTRGLAX3M-00	-			transparentna transparent прозрачная	

Ostonki / Covers / Крышки





PA-OSMLGLAX3M-00

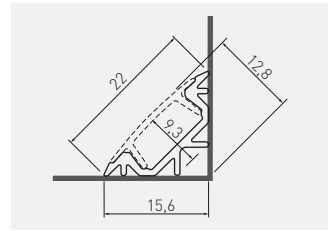

PA-OSTRGLAX3M-00

Profil GLAX kątowy
GLAX corner profile
Профиль GLAX угловой



	 L m			
PA-GLAXKT-AL	2	profil profile профиль	srebrny silver серебристый	aluminium aluminium алюминий
PA-GLAXKT3M-AL	3			
PA-OSMLGLAX-00	2	ostonka cover крышка	mleczna frosted молочная	PC
PA-OSMLGLAX3M-00	3			
PA-OSTRGLAX-00	3		transparentna transparent прозрачная	
PA-OSTRGLAX3M-00	2			
PA-ZASGLAXKT-00	-	zaślepka end cap заглушка	szary gray серый	ABS



Profil GLAX kątowy, wpuszczany
 Recessed corner profile GLAX
 Профиль GLAX угловой, врезной

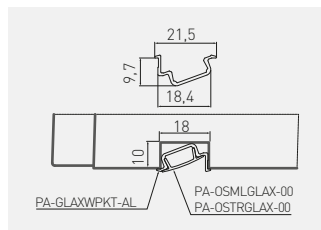

Kąt świecenia 22°
 Beam angle 22°
 Угол свечения 22°

PA-GLAXWPKT-AL	2 m	profil profile профиль	srebrny silver серебристый	aluminium aluminium алюминий
PA-OSMLGLAX-00		osłonka cover крышка	mleczna frosted молочная	PC
PA-OSTRGLAX-00			transparentna transparent прозрачная	

Ostonki / Covers / Крышки



PA-OSMLGLAX-00



PA-OSTRGLAX-00

Zestaw GLAX wpuszczany
 GLAX recessed - kit
 Комплект профиль GLAX врезной

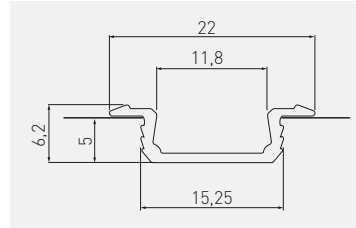

PA-ZGLAXOMZ-00

2

srebrny, silver, серебристый

aluminium, PC mleczne, ABS
 aluminium, PC frosted, ABS
 алюминий, PC молочная, ABS

Zestaw GLAX nakładany mini
 GLAX profile mini surface mounted - kit
 Комплект профиль GLAX накладной, мини

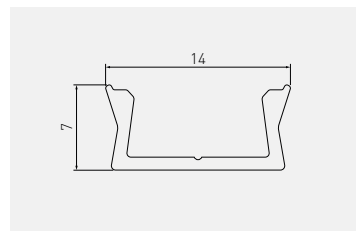

PA-ZGLAXMNMKOMZ-00





2

srebrny, silver, серебристый

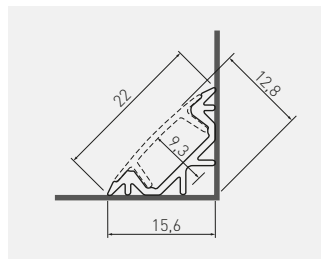
aluminium, PC mleczne, ABS
 aluminium, PC frosted, ABS
 алюминий, PC молочная, ABS





Zestaw GLAX kątowy
GLAX corner profile - kit
Комплект профиль GLAX угловой

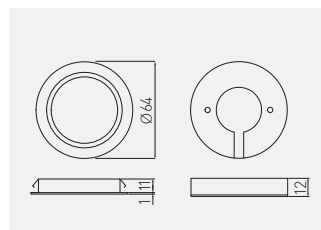

			
PA-ZGLAXKTOMZ-00	2	srebrny, silver, серебристый	aluminium, PC mleczne, ABS aluminium, PC frosted, ABS алюминий, PC молочная, ABS

Oprawa VASCO nakładana / wpuszczana
Fixture Vasco surface mounted / recessed
Светильник Vasco накладной / врезной



				
LD-VA24CB-53	130 lm	3000 K	aluminium aluminium алюминий	tworzywo plastic пластик
LD-VA24NE-53		4000 K		
LD-VA24ZB-53		6000 K		



Оправа LUMINO
 Fixture LUMINO
 Светильник LUMINO

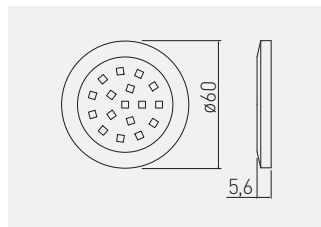

LD-LU16CB-53	70 - 85 lm	2700 K	biały połysk white gloss белый глянец	tworzywo plastic пластик
LD-LU16NE-53		4000 K		
LD-LU16ZB-53		6500 K		



Оправа CASTELLO z włącznikiem
 Fixture CASTELLO with switch
 Светильник CASTELLO с выключателем

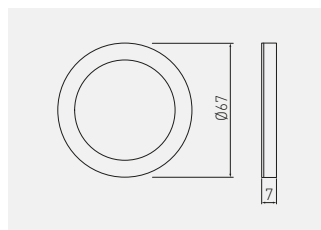

LD-CS36CB-53	180 lm	3000 K	aluminium aluminium алюминий	tworzywo plastic пластик
LD-CS36NE-53		4000 K		
LD-CS36ZB-53		6200 K		





Оправа ALVARO wpuszczana
 Recessed fixture ALVARO
 Врезной светильник ALVARO

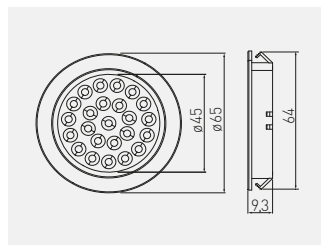

LD-AL24CB-53	130 lm	● 3000 K	aluminium aluminium алюминий	tworzywo plastic пластик
LD-AL24NE-53		● 4000 K		
LD-AL24ZB-53		● 6400 K		



Оправа VEGAS
 Fixture VEGAS
 Светильник VEGAS

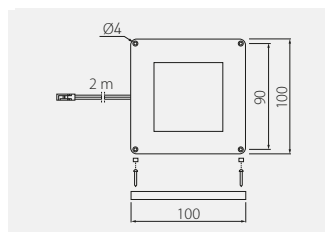

LD-VE15CB-53N	140 lm	● 3000 K	aluminium aluminium алюминий	tworzywo / aluminium plastic / aluminium пластмасса / алюминий
LD-VE15NE-53N	145 lm	● 4000 K		
LD-VE15ZB-53N	150 lm	● 6400 K		



Оправа VEGAS 2 w 1
 Fixture VEGAS 2 in 1
 Светильник VEGAS 2 в 1

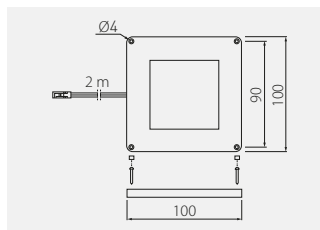

Powiązane produkty:
 Włącznik dotykowy bezprzewodowy CCT
 AE-WDBP2CCT-10, AE-WDBP2CCT-20
 Related products:
 Wireless touchless switch CCT
 AE-WDBP2CCT-10, AE-WDBP2CCT-20
 Связанные с ними продукты:
 Беспроводной сенсорный выключатель CCT
 AE-WDBP2CCT-10, AE-WDBP2CCT-20



LD-VE15CBZB-53N	140 lm	3000 K - 6400 K	aluminium aluminium алюминий	tworzywo, aluminium plastic, aluminium пластмасса, алюминий



Оправа TREVI
 Fixture TREVI
 Светильник TREVI

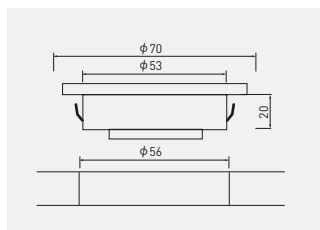

LD-TR24CB-53	300 lm	3000 K	aluminium aluminium алюминий	tworzywo plastic пластик
LD-TR24NE-53	220 lm	4000 K		
LD-TR24ZB-53	300 lm	6400 K		



Zestaw opraw CASTELLO z włącznikiem
 Fixture kit with switch CASTELLO
 Комплект светильников CASTELLO с выключателем

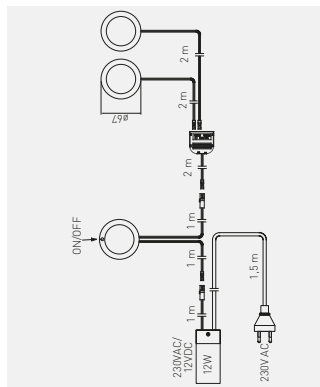
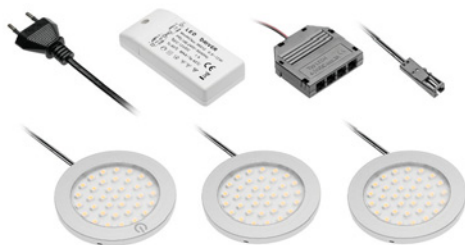

LD-Z3CSCB-53	3 x 180 lm	3000 K	aluminium / aluminium / алюминий	tworzywo / plastic / пластик



Zestaw opraw BARRI
 Fixture kit BARRI
 Комплект светильников BARRI

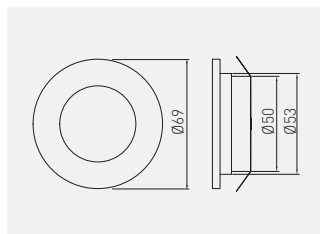

LD-OBP27CB-53	3 x 80 lm	2700 K	aluminium aluminium алюминий	aluminium, tworzywo aluminium, plastic алюминий, пластмасса
LD-OBP27ZB-53		6400 K		



Zestaw opraw MARBELLA
 Fixture kit MARBELLA
 Комплект светильников MARBELLA

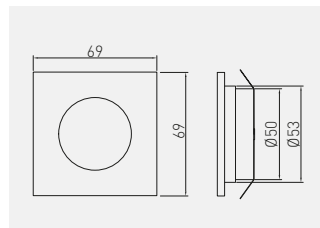

LD-KWP27CB-53	3 x 80 lm	● 2700 K	aluminium aluminium алюминий	aluminium, tworzywo aluminium, plastic алюминий, пластмасса
LD-KWP27ZB-53		● 6400 K		



Oprawa OVIEDO wpuszczana
 Recessed fixture OVIEDO
 Врезной светильник OVIEDO

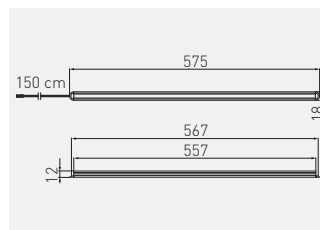

LD-WL2457-53	90 lm	● 6400 K	aluminium aluminium алюминий	aluminium, tworzywo aluminium, plastic алюминий, пластмасса



Oprawa OPD podszafkowa
Under cabinet LED lamp fixture OPD
Светодиодный светильник OPD под шкафчик

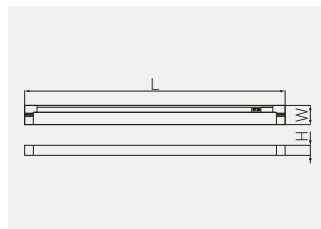

LD-OPD5W0-CB	5 W	300 lm	3000 K	325 × 30 × 22	chrom chrom хром	metal metal металл
LD-OPD9W0-CB	9 W	350 lm		585 × 30 × 22		



Oprawa RADIUS II na wysięgniku
Fixture with arm RADIUS II
Светильник типа „дуга” RADIUS II

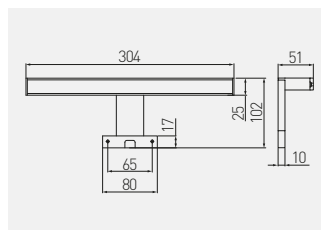

LD-RA60CB-40N	220 lm	3000 K	chrom chrome хром	tworzywo plastic пластмасса
LD-RA60ZB-40N		6000 K		



Oprawa COMA bezprzewodowa
Wireless fixture COMA
Беспроводной светильник COMA



LD-IRUSB-53

LD-PIRUSB-53

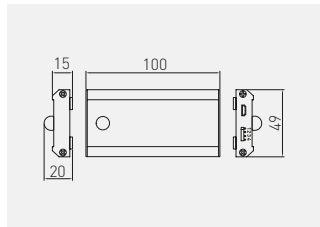

Dodatkowy przewód USB (do ładowania) – 0,5 m w komplecie
Additional 0,5m USB cable (for charging)

Дополнительный кабель USB (для зарядки) – 0,5 м

LD-IRUSB-53		40 – 50 lm	● 4000 K	Czujnik zbliżeniowy IR, jedno- lub dwubiegowy Proximity sensor IR, single or double-pole Датчик движения IR, одно- и многофункциональный	aluminium aluminium	stal, tworzywo steel, plastic
LD-PIRUSB-53				Czujnik ruchu PIR, jednobiegowy Proximity sensor IR, single-pole Датчик движения PIR, однофункциональный	aluminium алюминий	stal, tworzywo steel, plastic



Lampka CHICAGO z portem USB
Bed lamp with USB CHICAGO
Гибкая лампа с USB-разъемом CHICAGO

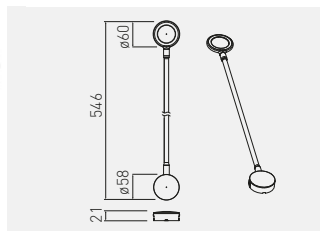

Wymaga zasilacza 12 V, 24 W
Requires 12 V, 24 W power supply
Требуется блок питания 12 В, 24 Вт

LD-CHIC16NE-10DIM		120 lm	● 4000 K	biały / white / белый	metal, tworzywo metal, plastic	
LD-CHIC16NE-20DIM				czarny / black / чёрный	metal, tworzywo metal, plastic	



Lampka BOSTON
Lamp BOSTON
Лампа BOSTON

360°

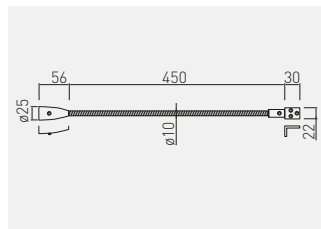

Wymaga zasilacza 12 V, 6 W
Requires 12 V, 6 W power supply
Требуется блок питания 12 В, 6 Вт

LD-BOS1CBWG-53	90 lm	3000 K	aluminium aluminium алюминий	stal, aluminium, tworzywo steel, aluminium, plastic сталь, алюминий, пластмасса



Klip plastikowy LED do półek
Plastic LED clip for shelves
Пластиковая клипса LED для стеклянных полок

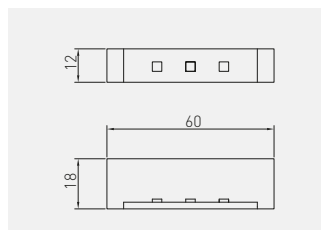

LD-KLPCB-00N	10 lm	3000 K	tworzywo plastic пластик
LD-KLPNB-00N	-	niebieski / blue / синий	
LD-KLPZB-00N	12 lm	6400 K	



Klip metalowy LED do półek
Metal LED clip for shelves
Металлическая клипса LED для стеклянных полок

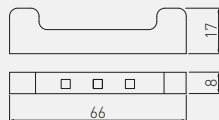
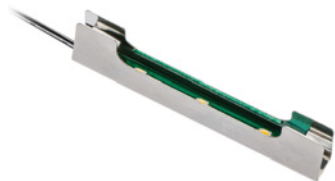

LD-3SKL-CBN	10 lm	3000 K	stal steel сталь	
LD-3SKL-NBN	-	niebieski / blue / синий		
LD-3SKL-ZBN	12 lm	6400 K		



Zasilacz LED EASY CLIK
LED power supply EASY CLIK
Блок питания LED EASY CLIK

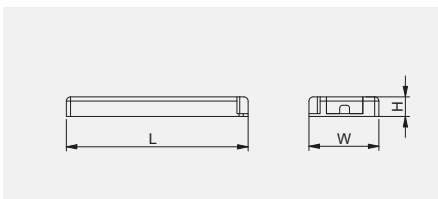





LD-ZAS09WEC-30	9 W	3 miniAMP	0,75 A	103 x 41 x 12mm	tworzywo plastic пластик	110 g	
LD-ZAS15WEC-30	15 W	4 miniAMP	1,25 A	129 x 42 x 16 mm		130 g	
LD-ZAS20WEC-30	20 W	4 miniAMP	1,67 A	129 x 42 x 16 mm		140 g	
LD-ZAS30WEC-30	30 W	6 miniAMP	2,5 A	160 x 50 x 18 mm		190 g	
LD-ZAS60WEC-30	60 W	6 miniAMP	5 A	190 x 62 x 21 mm		290 g	

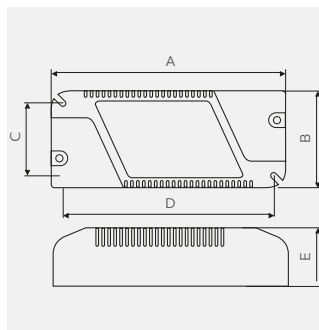

Zasilacz LED
LED power supply
Светодиодный трансформатор LED





				
LD-ZAS75W-30	max 75 W	180 x 52 x 42 x 176 x 30	350 g	tworzywo plastic пластик

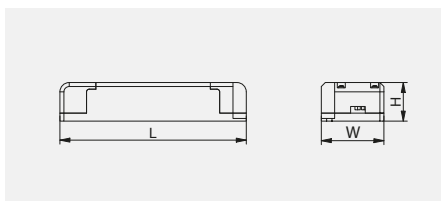

Zasilacz LED 24 V
LED power supplies 24 V
Блоки питания LED 24 V



				
LD-ZAS24PRO80W-30	max. 80 W	181 x 63 x 40 mm	300 g	tworzywo plastic пластик



Układ zasilający
Power feeder set
Блок питания



LD-ZZAS07PROKD6	7 W	100 x 39 x 25	tworzywo plastic пластик
LD-ZZAS12PROKD6	12 W	120 x 42 x 27	
LD-ZZAS16PROKD6	16 W	120 x 42 x 27	
LD-ZZAS24PROKD6	24 W	140 x 47 x 29	
LD-ZZAS33PROKD6	33 W	155 x 53 x 30	

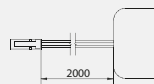
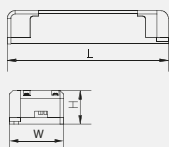

Zasilacz LED PRO
LED PRO power feeder units
Блоки питания LED PRO

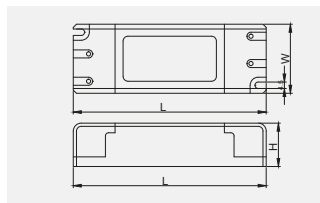

LD-ZASPRO07W-30	7 W	100 x 39 x 25 mm	tworzywo plastic пластик
LD-ZASPRO12W-30	12 W	120 x 42 x 27 mm	
LD-ZASPRO16W-30	16 W	120 x 42 x 27 mm	
LD-ZASPRO24W-30	24 W	140 x 47 x 29 mm	
LD-ZASPRO33W-30	33 W	140 x 47 x 29 mm	
LD-ZASPRO54W-30	54 W	155 x 53 x 30 mm	
LD-ZASPRO65W-30	65 W	181 x 63 x 40 mm	
LD-ZASPRO80W-30	80 W	181 x 63 x 40 mm	



Zasilacz LED
Power supply
Блок питания для светодиодных светильников

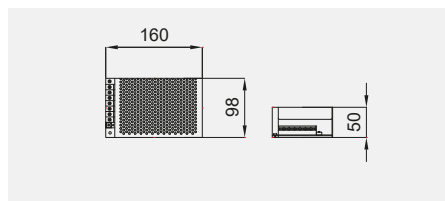
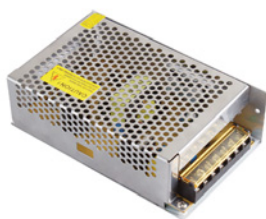

LD-ZAS150-NW	max. 150 W	347 g	aluminium aluminium алюминий
--------------	------------	-------	------------------------------------



Zasilacz LED
Power supply
Блок питания для светодиодных светильников

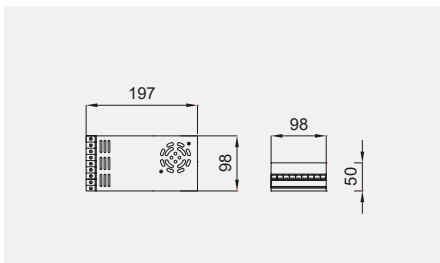

LD-ZAS350-NW	max. 350 W	589 g	aluminium aluminium алюминий



Zasilacz LED
Power supply
Блок питания для
светодиодных светильников

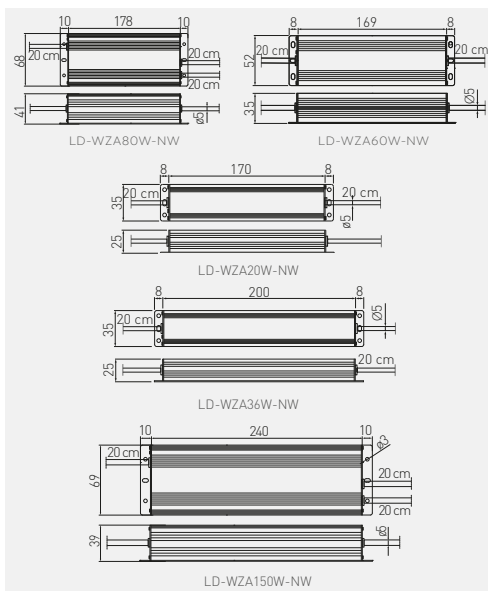

LD-WZA20W-NW	20 W	170 g	tworzywo plastic пластик
LD-WZA36W-NW	36 W	310 g	
LD-WZA60W-NW	60 W	990 g	
LD-WZA80W-NW	80 W	1000 g	
LD-WZA150W-NW	150 W	2000 g	



Zasilacz LED puszkowy
LED power supply
Светодиодный трансформатор LED

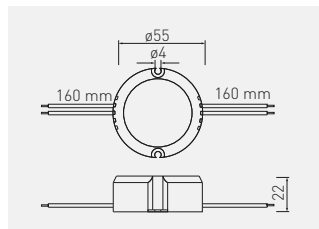

LD-ZASPU15W-30N	15 W	tworzywo / plastic / пластик

Układ zasilający do klipów LED 5-punktowy
Power supply set for 5 LED clips
Блок питания для светодиодных клипс, 5 разъёмов

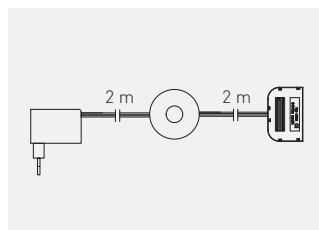

LD-ZSKL15-00N	tworzywo / plastic / пластик

Układ zasilający
Power supply set
Блок питания

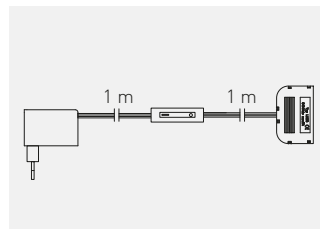

LD-ZWND6W-10	max. 6 W	tworzywo plastic / пластик
LD-ZWND12-10	max. 12 W	



Zestaw RGB – kontroler, zasilacz LED 6W, pilot i dystrybutor
RGB kit – RGB controller, power supply, remote and distributor
Комплект RGB – контролер, трансформатор 6W, пульт, дистрибьютор

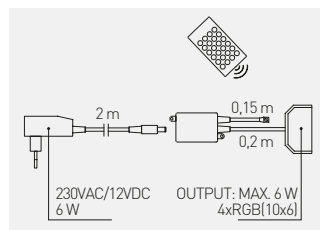

LD-ZAC6WDE-RGB	RGB	tworzywo / plastic / пластик



Kontroler RGB mini z pilotem
 Mini RGB controller with remote
 Миниконтроллер RGB с пультом

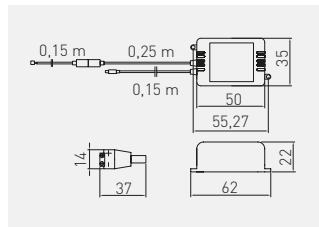

LD-KONMINI-RGB

RGB

tworzywo / plastic / пластик



Kontroler 1-strefowy MONO
 1-zone controller MONO
 1-х зонный контроллер MONO

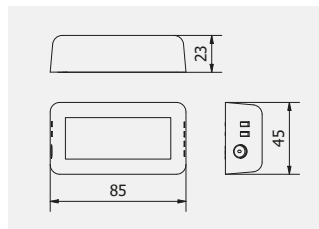

		
LD-KONML-MONO	MONO	tworzywo / plastic / пластик



Pilot 4-strefowy MONO
 4-zone remote controller MONO
 4-зонный пульт дистанционного управления MONO

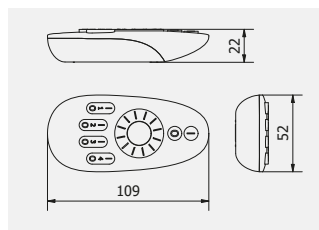

	
LD-KONML-MONO-PIL	tworzywo / plastic / пластик



Panel dotykowy 4-strefowy na baterie MONO
 Battery powered 4-zone touch panel MONO
 4-зонная сенсорная панель с батарейками MONO

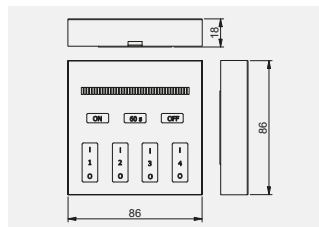

LD-KONML-MONO-PAN

tworzywo / plastic / пластик



Kontroler 1-strefowy RGBW
 1-zone controller RGBW
 1-х зонный контроллер RGBW

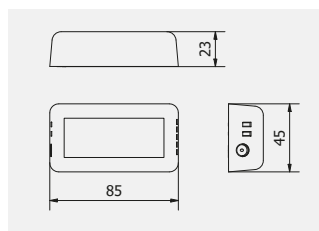

LD-KONML-RGBW



RGBW

tworzywo / plastic / пластик

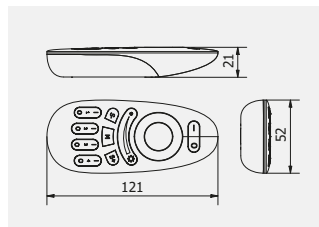

Pilot 4-strefowy RGBW
 4-zone remote controller RGBW
 4-зонный пульт дистанционного управления RGBW





		
LD-KONML-RGBW-PIL	RGBW	tworzywo / plastic / пластик

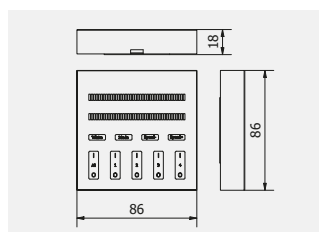
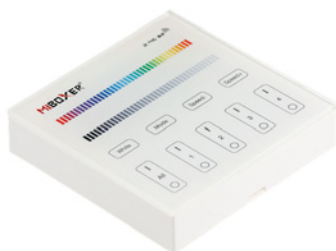

Panel dotykowy 4-strefowy na baterie RGBW
 Battery powered 4-zone touch panel RGBW
 4-зонная сенсорная панель с батарейками RGBW



		
LD-KONML-WRGB-PAN	RGBW	tworzywo / plastic / пластик



Kontroler WiFi
WiFi-controller
WiFi – контроллер

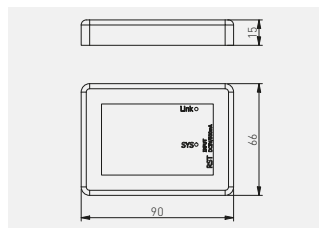

LD-KONML-WIFI



RGB



tworzywo / plastic / пластик



Adapter do pilota
Remote control adapter
Адаптер пульта дистанционного управления

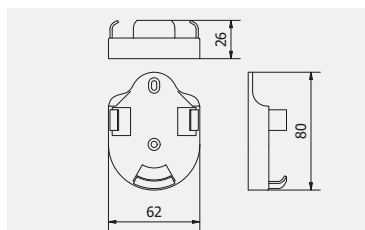

LD-KONML-AD



biały / white / белый



tworzywo / plastic / пластик



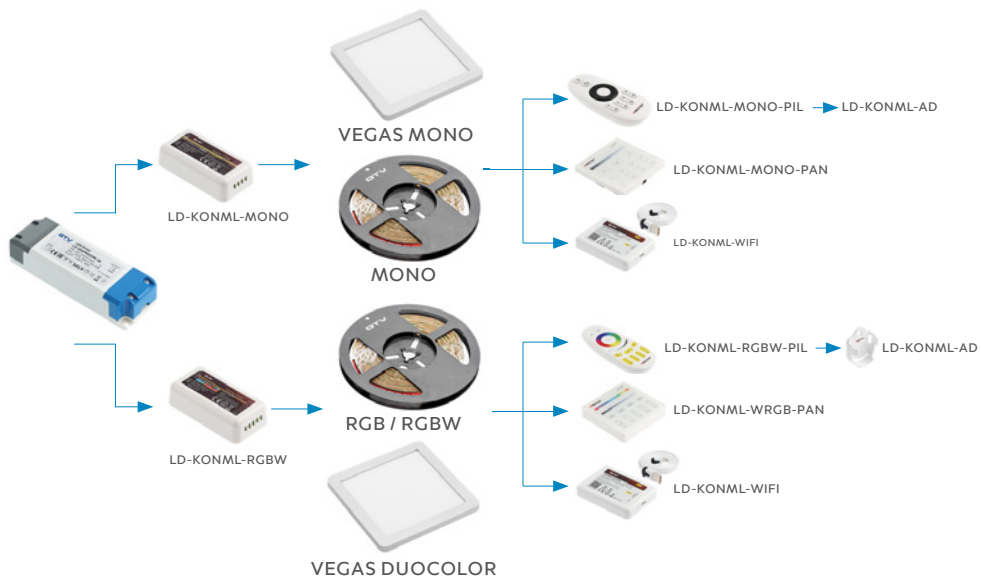

Włącznik dotykowy bezprzewodowy on-off
 Wireless touch switch on-off
 Беспроводной сенсорный выключатель on-off

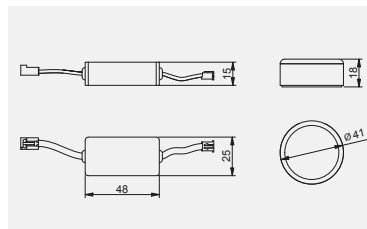
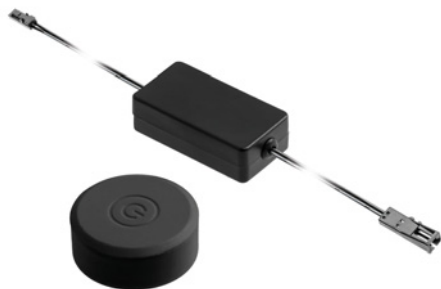

		
AE-WDBP1-10N	biały / white / белый	tworzywo plastic пластик
AE-WDBP1-20N	czarny / black / чёрный	



Włącznik dotykowy bezprzewodowy CCT
 Wireless touch switch CCT
 Беспроводной сенсорный выключатель CCT

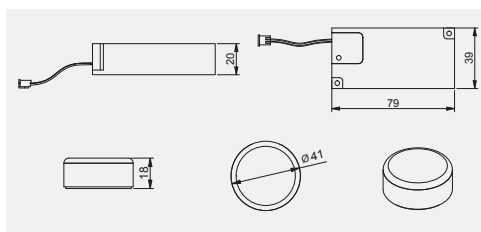
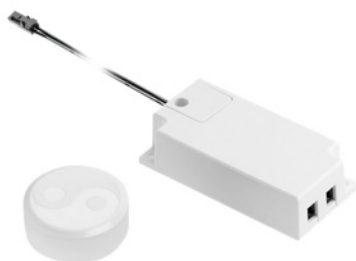

		
AE-WDBP2CCT-10N	biały / white / белый	tworzywo plastic пластик
AE-WDBP2CCT-20N	czarny / black / чёрный	





Włącznik bezdotykowy
Touchless switch
Бесконтактный датчик

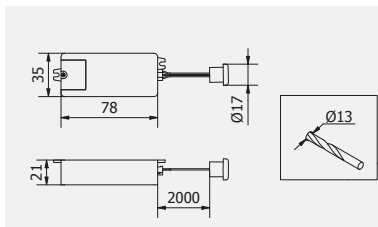

AE-WBEZDC-10S	dwubiegowy two-pole двухфункциональный	tworzywo plastic пластик
AE-WBEZDB-10S*	jednobiegowy single-pole однофункциональный	



Włącznik dotykowy pod śrubę
Touch switch under screw
Сенсорный выключатель под винт

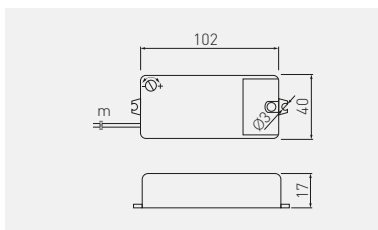

AE-WBEZDK15-10	tworzywo plastic пластмасса



Włącznik z czujnikiem ruchu PIR
Switch with PIR motion detector
Выключатель с датчиком движения PIR

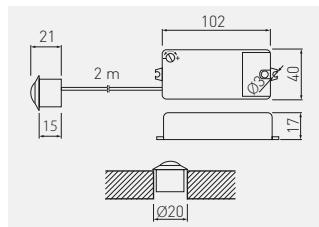



	
AE-WBEZDPIR-10	tworzywo plastic пластмасса

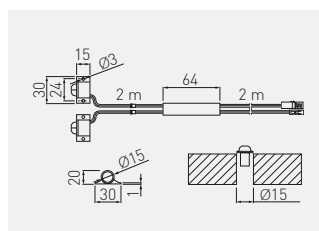

Włącznik z dwoma sensorami ruchu PIR II
Switch with two PIR II motion sensors
Выключатель с двумя датчиками движения PIR II



	
AE-WBEZDPIR2-20	tworzywo plastic пластмасса



Włącznik bezdotykowy uniwersalny 3 w 1
 3 in 1 all-purpose touchless switch
 Бесконтактный выключатель 3 в 1



dimmable



AE-ADCUNI-10

AE-ADBUNI-10

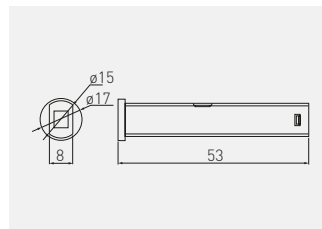

AE-WBBUNI-10DIM	biały / white / белый	tworzywo plastic / пластик
AE-WBCUNI-10DIM	czarny / black / чёрный	



Włącznik dotykowy ściemniający
 Dimmable touch switch
 Выключатель с регулятором яркости



dimmable

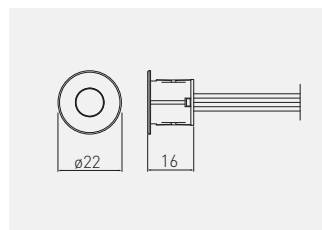

AE-WDSB-10DIM	biały / white / белый	tworzywo plastic / пластик
AE-WDSC-10DIM	czarny / black / чёрный	



Włącznik dotykowy ściemniający
Dimmable touch switch
Выключатель с регулятором яркости

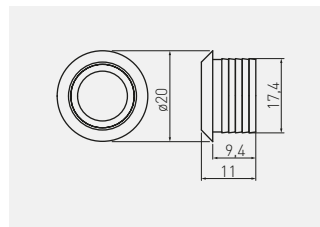

AE-WBEZD-NB	chrom chrome хром	tworzywo plastic пластик



Włącznik podblatowy
Countertop switch
Выключатель под столешницу

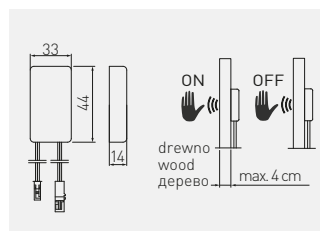

Grubość blatu max. 40 mm
Countertop thickness max. 40 mm
Толщина столешницы макс. 40 мм

AE-WPDRW-00	tworzywo / plastic / пластик



Włącznik do taśm LED montowany w profil
 Switch for LED strips mounted in profile
 Выключатель для ленты LED

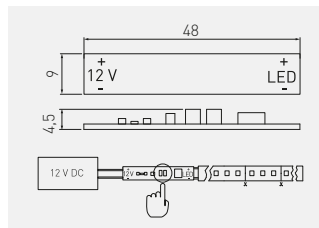

AE-WLPR-60	-	biały white белый	plytka elektroniczna circuit board электронная плата	1000
AE-WLPR-60P2	2 m			500



Włącznik kotykowski
 Switch
 Выключатель кнопочный

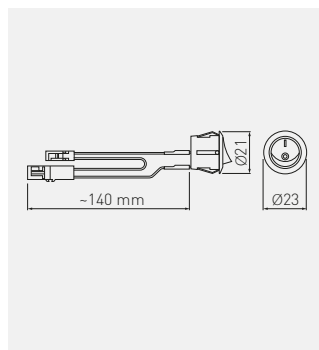

AE-WLB01-10	biały / white / белый	tworzywo plastic пластик
AE-WLC01-20	czarny / black / чёрный	



Przetącnik kotyskowy okrągły
 Round rocker switch
 Выключатель клавишный круглый



AE-WLIP44-15	biały white белый	tworzywo plastic пластмасса



Ściemniacz LED
 LED dimmer
 Светодиодный диммер

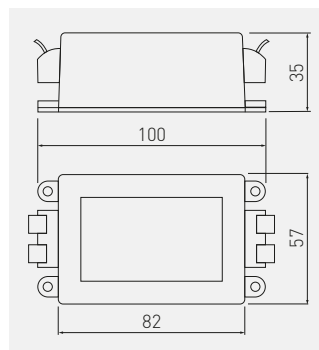

LD-DIMLED-10	czarny / black / чёрный	PC



Włącznik tańcuszkowy

Pull chain switch

Выключатель для бра и торшеров с цепочкой

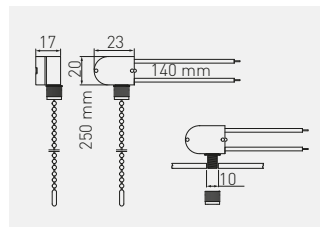

AE-WLLAN1-10	chrom / chrome / хром	tworzywo / plastic / пластик
AE-WLLAN1-90	złoty / gold / золотой	
AE-WLLAN1-20	czarny / black / черный	



Włącznik sznurkowy

Pull cable switch

Шнурочный выключатель



AE-WLSZN1-10	czarny / black / чёрный	polipropylen / polypropylene / полипропилен
--------------	-------------------------	---



Kabel zasilający z wtyczką i włącznikiem
 Cable with plug & switch
 Кабель с вилкой и выключателем

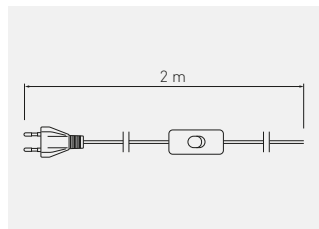

		
LD-KABE2M-00	biały / white / белый	tworzywo / plastic / пластик



Przewód ze złączką mini AMP
 Cable with Mini AMP
 Кабель с соединителем мини-AMP

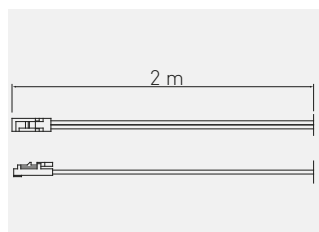

		
LZ-KA2MM-10	czarny / black / чёрный	tworzywo / plastic / пластик





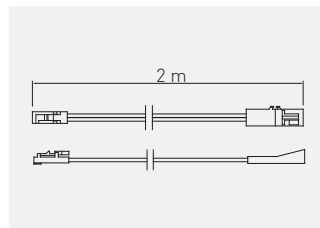





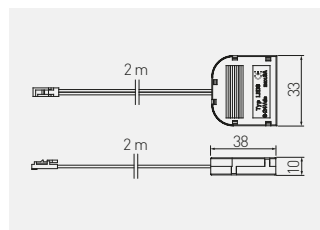



Przewód ze złączkami mini AMP
 Cable with Mini AMP
 Кабель с соединителями мини-AMP



		
LZ-KAPR2M-10	czarny / black / чёрный	tworzywo / plastic / пластик
		
		
		

Złączka do oświetlenia ledowego z dystrybutorem, 3 gniazda
 LED lamp connector with distributor, 3 sockets
 Соединитель LED с распределителем, 3 гнезда



		
LZ-AKZ312-10N	czarny / black / чёрный	tworzywo / plastic / пластик
		
		
		

Złączka do oświetlenia ledowego z dystrybutorem, 6 gniazd
 LED lamp connector with distributor, 6 sockets
 Соединитель LED с распределителем, 6 гнезд

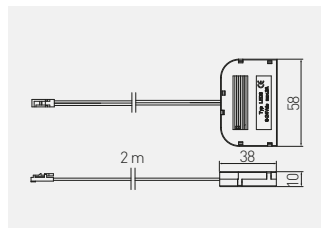

LZ-AKZ612-10N	czarny / black / чёрный	tworzywo / plastic / пластик



Złączka XC11 do taśm LED
 Connector XC11 for LED strips
 Соединитель XC11 для лент LED



LD-ZTL8MM-02N



LD-ZTL8MM-02N600



LD-ZTL10MM-02N



LD-ZTLRGB-04N

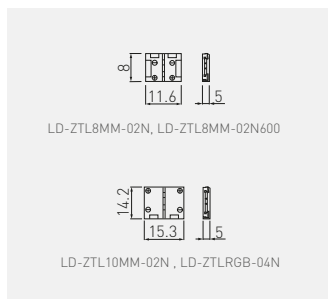

LD-ZTL8MM-02N	8 mm	tworzywo plastic пластик
LD-ZTL8MM-02N600	8 mm, 600 LED	
LD-ZTL10MM-02N	10 mm	
LD-ZTLRGB-04N	RGB	



Złączka XC11 do taśm LED kątowa
 Angular connector XC11 for LED strips
 Угловой соединитель XC11 для лент LED



LD-ZTKT8MM-02N

LD-ZTKT8MM-02N600



LD-ZTKT10MM-02N

LD-ZTKTRGB-02N

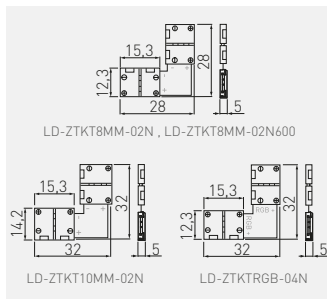

LD-ZTKT8MM-02N	8 mm	tworzywo plastic пластик
LD-ZTKT8MM-02N600	8 mm / 600 LED	
LD-ZTKT10MM-02N	10 mm	
LD-ZTKTRGB-04N	RGB	



Złączka XC11 do taśm LED z przewodem 15 cm
 Connector XC11 with 15 cm cord, for strips
 Соединитель XC11 для лент LED, с проводом 15 см



LD-ZTK8MM-02N

LD-ZTK8MM-02N600

LD-ZTK10MM-02N

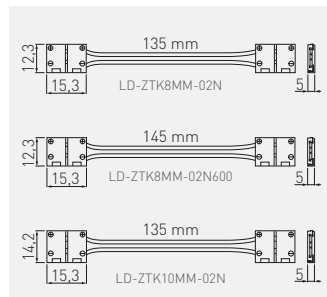

LD-ZTK8MM-02N	8 mm	tworzywo plastic пластик
LD-ZTK8MM-02N600	8 mm / 600 LED	
LD-ZTK10MM-02N	10 mm	



Złącza XC11 do taśm LED z przewodem 2 m
 Connector XC11 with 2 m cord, for LED strips
 Соединитель XC11 для лент LED, с проводом 2 м

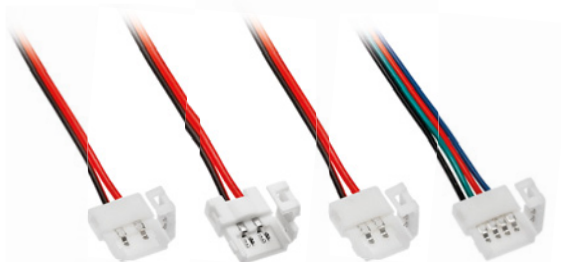

LD-ZTL82M-2N LD-ZTL82M-2N600 LD-ZTL102M-2N LD-ZTLRGB2M-4N

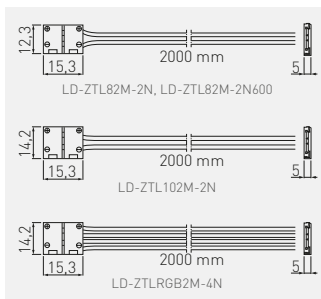

LD-ZTL82M-2N	8 mm	tworzywo plastic пластик	
LD-ZTL82M-2N600	8 mm / 600 LED		
LD-ZTL102M-2N	10 mm		
LD-ZTLRGB2M-4N	RGB		



Złącza XC11 do taśm LED z przewodem 2 m i mini amp
 Connector XC11 with 2 m cord and mini AMP, for LED strips
 Соединитель XC11 для лент LED, с проводом 2 м и мини amp

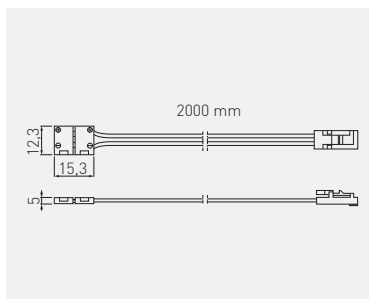

LD-ZTL8MMAMP-02N	8 mm	tworzywo plastic пластик	
LD-ZTL8MMAMP-02N600	8 mm / 600 LED		



Złączka XC11 do taśm LED SLIM
 Connector XC11 for LED strips SLIM
 Соединитель XC11 для лент LED SLIM



LD-ZTLS8MM-02N

LD-ZTKS8MM-02N

LD-ZTLS82M-2N

LD-ZTLS8MMAMP-02N

LD-ZTLS8MM-02N	8 mm	tworzywo plastic пластик
LD-ZTKS8MM-02N		
LD-ZTLS82M-2N		
LD-ZTLS8MMAMP-02N		

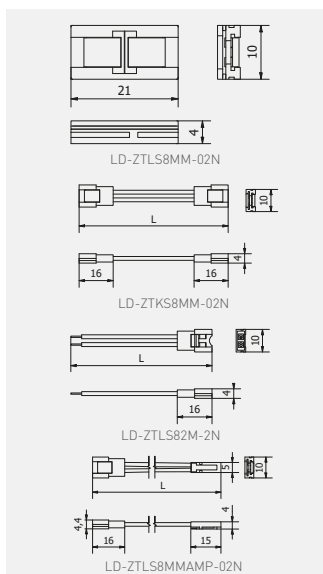

Ładowarka indukcyjna z zasilaczem
 Wireless charger with power supply
 Беспроводное зарядное устройство с блоком питания

360°

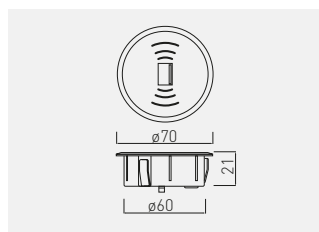

AE-ZUSB-20	czarny / black / чёрный	tworzywo plastic пластмасса



Ładowarka bezprzewodowa, indukcyjna, podblatowa z zasilaczem
 Wireless surface charger, under the countertop mount
 Беспроводное зарядное устройство, под столешницу

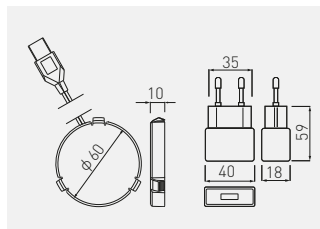

AE-ZLADPOD-20	czarny / black / чёрный	tworzywo plastic / пластик



Ładowarka bezprzewodowa LUX z zasilaczem
 Inductive charger with a power feeder LUX
 Зарядное устройство индукционное с блоком питания LUX

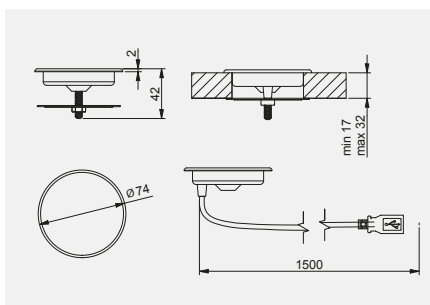

AE-ZLADLUX-40	chrom / chrome / хром	tworzywo plastic / пластик



Gniazdo meblowe wpuszczane PRESTINO
 Recessed power socket PRESTINO
 Мебельная розетка врезная PRESTINO



AE-PB2FPRES-10



AE-PB2FPRES-20



AE-PB2FPRES-53



AE-PB2SPRES-10



AE-PB2SPRES-20



AE-PB2SPRES-53



AE-PB2FPRES-20	USB-A + USB-C DC5V 3A (max 15,0W) DC9V 2A (MAX. 18,0W) DC12V 1.5A (MAX. 18,0W)	2 x french	aluminium, aluminio, Aluminium	aluminium + Plastique, aluminio + plastico, Aluminium + Kunststoff
AE-PB2SPRES-20		2 x schuko		
AE-PB2FPRES-53		2 x french		
AE-PB2SPRES-53		2 x schuko		
AE-PB2FPRES-10		2 x french		
AE-PB2SPRES-10		2 x schuko		

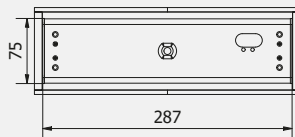
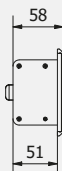
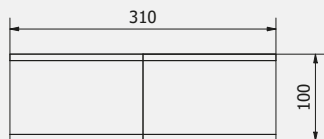



Gniazdo meblowe wpuszczane CHARGER PLUS
 Recessed power socket CHARGER PLUS
 Мебельная розетка врезная CHARGER PLUS



AE-BPW1FACP-10



AE-BPW1SACP-10

AE-BPW1FACP-10	USB A+C 5V/2.4A interchangeable: USB A, HDMI, RJ45	1 x french	biały / white / белый	tworzywo plastic пластик
AE-BPW1FACP-20		1 x french	czarny / black / чёрный	
AE-BPW1SACP-10		1 x schuko	biały / white / белый	
AE-BPW1SACP-20		1 x schuko	czarny / black / чёрный	

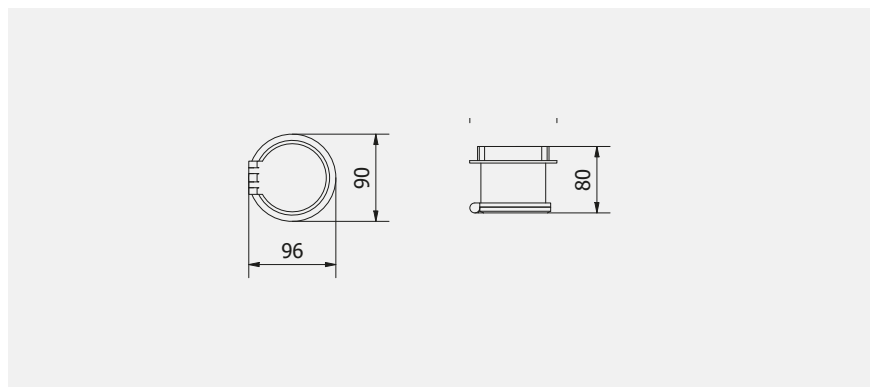



Gniazdo meblowe wpuszczane COMFORT PLUS
 Recessed power socket COMFORT PLUS
 Мебельная розетка врезная COMFORT PLUS



AE-BPW4F120P-10



AE-BPW4S120P-10

AE-BPW4F120P-10	2xUSB 5V/3,1A AC/DC; 5,12,24,220-240V; 50-60Hz	4 x french	biały / white / белый	tworzywo plastic пластик
AE-BPW4F120P-20			czarny / black / чёрный	
AE-BPW4S120P-10		4 x schuko	biały / white / белый	
AE-BPW4S120P-20			czarny / black / чёрный	

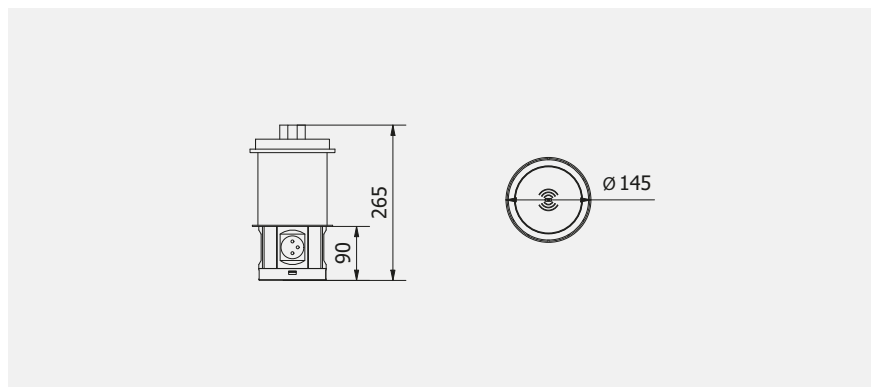



Gniazdo meblowe wpuszczane CAMINO
 Recessed power socket CAMINO
 Мебельная розетка врезная CAMINO



AE-BPW2FCAM-20



AE-BPW2FCAM-10

AE-BPW2FCAM-20	USB-A + USB-C DC5V 3A (max 15,0W) DC9V 2A (MAX. 18,0W) DC12V 1.5A (MAX. 18,0W)	2 x french	czarny / black / чёрный	aluminium tworzywo aluminium plastic алюминий пластик
AE-BPW2SCAM-20		2 x schuko		
AE-BPW2FCAM-10		2 x french	biały / white / белый	
AE-BPW2SCAM-10		2 x schuko		

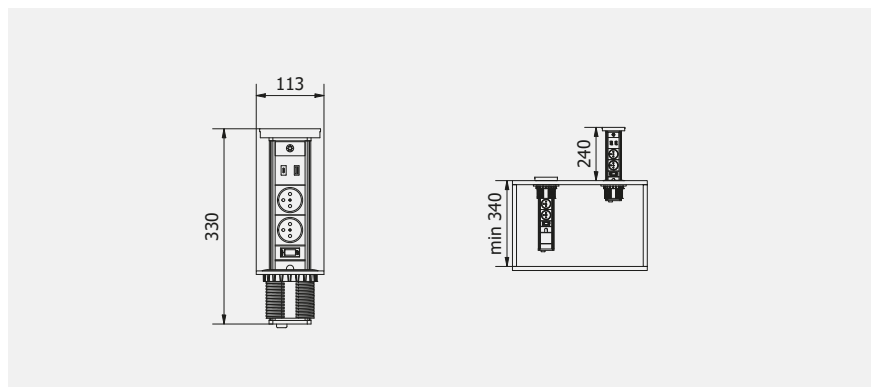



Gniazdo meblowe wpuszczane AVARO PLUS
 Recessed power socket AVARO PLUS
 Мебельная розетка врезная AVARO PLUS



AE-PB1FAVAP-10



AE-PB1SAVAP-10

AE-PB1FAVAP-20	USB-A + USB-C DC5V 3A (max 15,0W) DC9V 2A (MAX. 18,0W) DC12V 1.5A (MAX. 18,0W)	1 x french	czarny / black / чёрный	aluminium tworzywo aluminium plastic алюминий пластик
AE-PB1SAVAP-20		1 x schuko		
AE-PB1FAVAP-53		1 x french	szary / gray / серый	
AE-PB1SAVAP-53		1 x schuko		
AE-PB1FAVAP-10		1 x french	biały / white / белый	
AE-PB1SAVAP-10		1 x schuko		

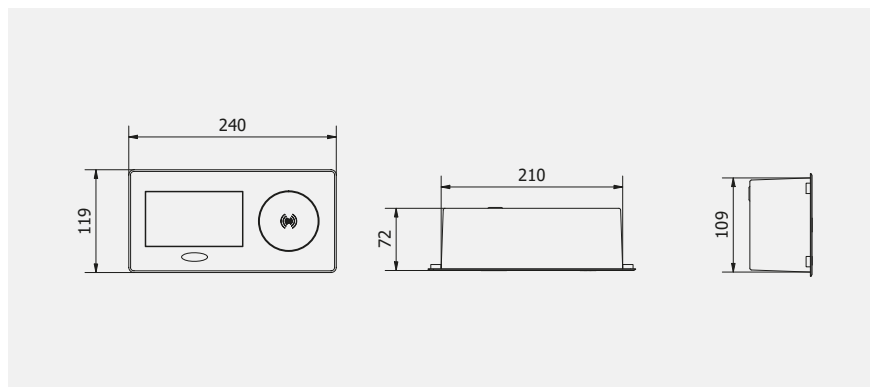



Gniazdo meblowe wpuszczane AVARO
 Recessed power socket AVARO
 Мебельная розетка врезная AVARO



AE-PB1FAVA-10



AE-PB1SAVA-10



AE-PB1FAVA-20	USB A DC5V 2A (MAX. 10,0W)	1 x french	czarny / black / чёрный	aluminium tworzywo, aluminium plastic, алюминий пластик
AE-PB1SAVA-20		1 x schuko		
AE-PB1FAVA-53		1 x french	szary / gray / серый	
AE-PB1SAVA-53		1 x schuko		
AE-PB1FAVA-10		1 x french	biały / white / белый	
AE-PB1SAVA-10		1 x schuko		

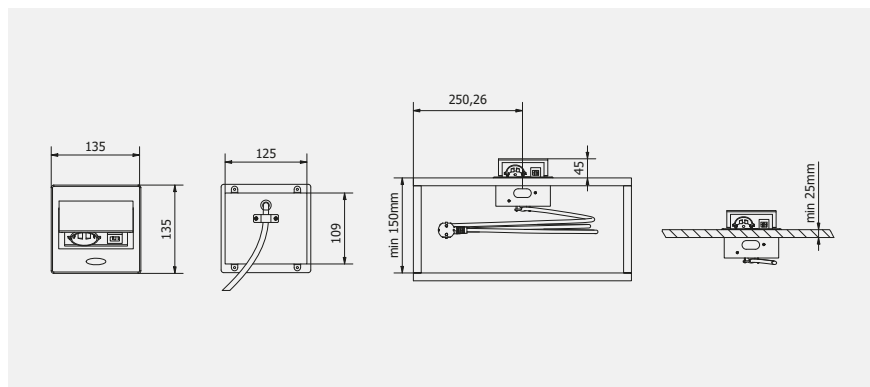



GTV
LIGHTING

GTV
LIGHTING

Gniazdo meblowe wpuszczane CHARGER
 Recessed power socket CHARGER
 Мебельная розетка врезная CHARGER



AE-BPW1S2UCH-80

AE-BPW1U2UCH-80

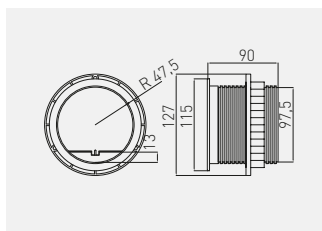

AE-BPW1S2UCH-80	1 x schuko	srebrny silver серебристый	tworzywo plastic пластмасса
AE-BPW1U2UCH-80	1 x french		



Gniazdo meblowe wpuszczane CHARGER MINI
 Recessed power socket CHARGER MINI
 Мебельная розетка врезная CHARGER MINI



AE-BPW1S1UCH-53

AE-BPW1U1UCH-53

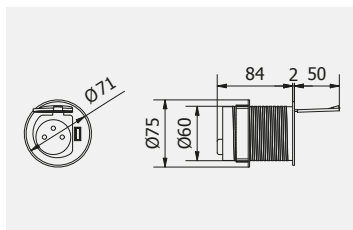

AE-BPW1U1UCH-53	1 x french	aluminium aluminium алюминий	tworzywo plastic пластмасса
AE-BPW1S1UCH-53	1 x schuko		



Gniazdo meblowe wpuszczane SLIDE
 Recessed power socket SLIDE
 Мебельная розетка врезная SLIDE



AE-BPW1U1UCH-51

AE-BPW1S1UCH-51

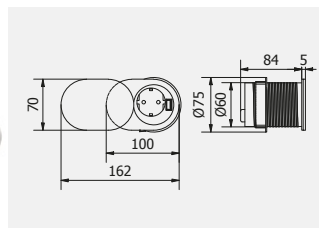

AE-BPW1U1UCH-51	1 x french	USB 5V / 2,4A	aluminium aluminium алюминий	tworzywo plastic пластмасса
AE-BPW1S1UCH-51	1 x schuko			



Gniazdo meblowe wpuszczane COMFORT
 Recessed power socket COMFORT
 Мебельная розетка врезная COMFORT

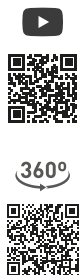

AE-BPW3S100U-53

AE-BPW4U100-53

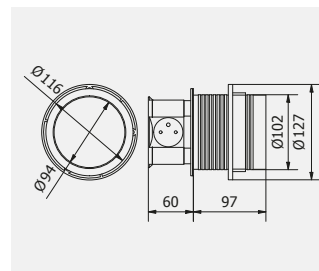

AE-BPW4U100-53	4 x french	-	aluminium aluminium алюминий	aluminium, tworzywo aluminium, plastic алюминий, пластмасса
AE-BPW4S100-53	4 x schuko			
AE-BPW3U100U-53	3 x french	5V USB max. 2A		
AE-BPW3S100U-53	3 x schuko			



Gniazdo meblowe wpuszczane okrągłe $\varnothing 100$

Round recessed power socket $\varnothing 100$

Мебельная розетка врезная круглая $\varnothing 100$

360°



AE-BPW3GU-80



AE-BPW3GU-20

AE-BPW3GU-20	100	3 x french	czarny / black / чёрный	aluminium, tworzywo aluminium, plastic алюминий, пластмасса
AE-BPW3GU-80			srebrny / silver / серебристый	
AE-BPW3GS-20		3 x schuko	czarny / black / чёрный	
AE-BPW3GS-80			srebrny / silver / серебристый	

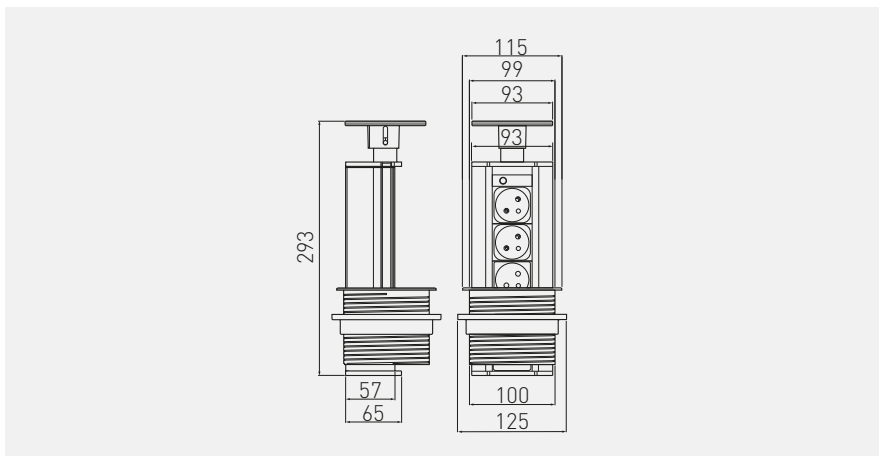



Gniazdo meblowe wpuszczane okrągłe $\varnothing 60$
 Round recessed power socket $\varnothing 60$
 Мебельная розетка врезная круглая $\varnothing 60$

360°



AE-BPW3U60-20



AE-BPW3U60-80



AE-BPW3U60U-20



AE-BPW3U60U-80

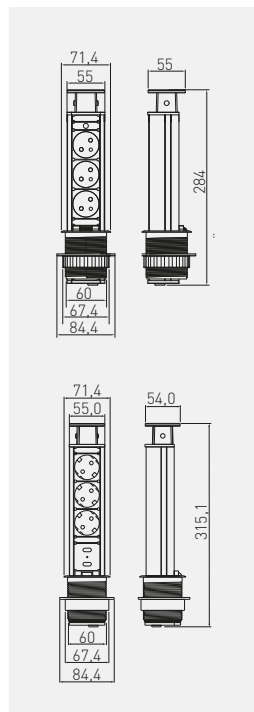

AE-BPW3U60-20	60	3 x french	5V USB max. 2A	czarny / black / чёрный	aluminium, tworzywo aluminium, plastic алюминий, пластмасса
AE-BPW3U60-80				srebrny / silver / серебристый	
AE-BPW3S60-20		3 x schuko		czarny / black / чёрный	
AE-BPW3S60-80				srebrny / silver / серебристый	
AE-BPW3U60U-20		3 x french		czarny / black / чёрный	
AE-BPW3U60U-80				srebrny / silver / серебристый	
AE-BPW3S60U-20		3 x schuko		czarny / black / чёрный	
AE-BPW3S60U-80				srebrny / silver / серебристый	



Gniazdo meblowe wpuszczane prostokątne
Rectangular recessed power socket
Мебельная розетка врезная прямоугольная



AE-PB03GS-53	-	3 x schuko	aluminium aluminium алюминий	stal, tworzywo steel, plastic сталь, пластмасса	
AE-PB03GS-20	-	3 x schuko			
AE-PB03GS-10	-	3 x schuko			
AE-PB03GU-53	-	3 x french			
AE-PBC3GU-53	1,5 m	3 x french			
AE-PBC3GU-20	1,5 m	3 x french	czarny / black / чёрный		
AE-PBC3GU-10	1,5 m	3 x french	biały / white / белый		



Gniazdo meblowe wpuszczane prostokątne
Rectangular recessed power socket
Мебельная розетка врезная прямоугольная



AE-PBU02GS-10	2 x schuko	biały / white / белый		stal, tworzywo steel, plastic сталь, пластмасса	
AE-PBU02GS-20		czarny / black / чёрный			
AE-PBU2GU-10	2 x french	biały / white / белый			
AE-PBU2GU-20		czarny / black / чёрный			
AE-PBU2GU-53		aluminium / aluminium / алюминий			



Gniazdo meblowe wpuszczane SOFT
 Recessed power socket SOFT
 Мебельная розетка врезная SOFT



360°



AE-PBSC3GS-20



AE-PBSUC2GS-20



AE-PBSC3GS-53



AE-PBSUC2GS-53



AE-PBSC3GS-10	3 x schuko	-	biały, white, белый	stal, tworzywo steel, plastic сталь, пластмасса
AE-PBSC3GS-20N			czarny, black, черный	
AE-PBSC3GS-53			aluminium, aluminium, алюминий	
AE-PBSC3GU-10	3 x french		biały, white, белый	
AE-PBSC3GU-20N			czarny, black, черный	
AE-PBSC3GU-53			aluminium, aluminium, алюминий	
AE-PBSUC2GS-10	2 x schuko	5V USB max 2A	biały, white, белый	
AE-PBSUC2GS-20N			czarny, black, черный	
AE-PBSUC2GS-53			aluminium, aluminium, алюминий	
AE-PBSUC2GU-10	2 x french		biały, white, белый	
AE-PBSUC2GU-20N			czarny, black, черный	
AE-PBSUC2GU-53			aluminium, aluminium, алюминий	

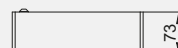



Gniazdo meblowe przepustowe z USB
Through-desk power socket with USB
Мебельная розетка проходная с USB

360°



AE-PBC3GS-53BKS



AE-PBC3GS2U-53BKS

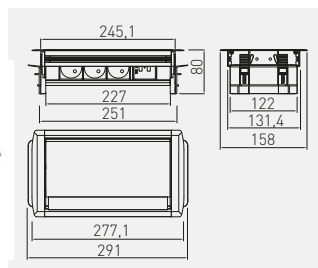

AE-PBC3GS-53BKS	3 x schuko	-	aluminium aluminium алюминий	aluminium, tworzywo aluminium, plastic алюминий, пластмасса
AE-PBC3GS2U-53BKS	3 x french	5V USB max. 2A		



Gniazdo meblowe bez kasety
Furniture power socket without housing
Мебельная розетка без корпуса



AE-PBC3GS-51BK



360°



AE-PBC3GU-51BK

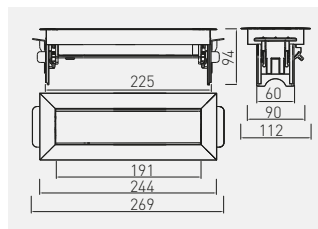

AE-PBC3GS-51BK	3 x schuko	stal szcztokowana brushed steel	stal, aluminium, tworzywo steel, aluminium, plastic
AE-PBC3GU-51BK	3 x french	шлифованная сталь	сталь, алюминий, пластмасса



Gniazdo meblowe kątowe
 Corner furniture power socket
 Мебельная розетка угловая



AE-PBKT4S-80

AE-PBKT3U2U-80

AE-PBKT4U-80	4 x french	-		srebrny silver серебристый	aluminium, tworzywo aluminium, plastic алюминий, пластмасса
AE-PBKT4S-80	4 x schuko				
AE-PBKT3U2U-80	4 x french	5V USB max. 2A			
AE-PBKT3S2U-80	4 x schuko				

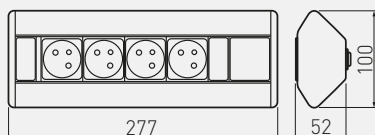

OBJAŚNIENIA IKON / ICONS EXPLANATION / ОПИСАНИЕ ИКОНОК

	indeks index индекс		szerokość width ширина		dotatkowe informacje additional information дополнительная информация
	wysokość prowadnika guide height высота чашки		wymiary (mm) dimensions (mm) размеры (мм)		stopień ochrony IP protection rating IP степень защиты IP
	wkręty zwykłe wood screws саморезы		wymiary (m) dimensions (m) размеры (м)		odległość cięcia cutting distance длина отрезка
	euro wkręty euro screws евро саморезы		grubość thickness толщина		szerokość taśmy strip width ширина ленты
	pokrycie finish покрытие		szerokość zewnętrzna szafki outside width of the cabinet наружная ширина ящика		USB USB USB
	kolor color цвет		materiał material материал		rodzaj gniazda socket type тип гнезда
	obciążenie load нагрузка		wysuw extension выдвижение		moc power номинальный режим
	pojemność capacity емкостность		kształt shape форма	Akcesoria meblowe Furniture accessories Мебельная фурнитура	
	siła oporu strenght сила опоры		strumień świetlny luminous flux номинальный световой поток		zawias nakładany overlay door накладная петля
	długość length длина		długość przewodu wire length длина провода		zawias bliźniaczy twin overlay полунакладная петля
	rozstaw size межцентровое расстояние		ilość diod number of diodes количество диод		zawias wpuszczany inset door вкладная петля
	wysokość height высота		kolor obudowy housing color цвет корпуса		zawias kątowy corner hinge угловая петля
	strata wysuwu extension loss потеря выдвижения		temperatura barwowa światła color temperature температура оттенка света		zawias o szerokim kącie otwarcia wide angle hinge петля с широким углом открывания
	średnica diameter диаметр		kąt świecenia beam angle угол свечения		zawias równoległy parallel hinge петля под фальшпанель (равнолежащая)

	zawias równoległy nakładany parallel hinge for overlay door петля накладная под фальшпанель		SLIDE-ON sposób montażu slide-on slide-on mounting надвижной монтаж slide-on		PUSH push-to-open
	zawias uzupełniający complementary hinge петля для складных дверей		SLOW zawias z mechanizmem cichego domykania hinge with soft closing петля с доводчиком Soft Close		FULL pełny wysuw full extension полное выдвижение
	regulacja adjustment регулировка		zawias ze sprężyną dociągającą hinge with closing spring петля с прижимной пружиной		szuflada standard standard drawer стандартный ящик
	działanie jednostopniowe single action hinge одношаговая петля		zawias samootwierający self-opening hinge петля самооткрывающаяся		szuflada zlewozmywakowa under sink drawer ящик под мойку
	działanie dwustopniowe double action hinge двухшаговая петля		zawias bez sprężyny hinge without spring петля без пружины		szuflada narożna corner drawer ящик угловой
	SPECIAL zawias do zastosowań specjalnych special hinge петля для специальных конструкций		A szuflada niska low drawer низкий ящик		szuflada standardowa standard drawer стандартный ящик
	Ø 35 mm średnica puszki hinge cup diameter диаметр чашки		B szuflada średnia medium drawer средний ящик		szuflada wewnętrzna inner drawer внутренний ящик
	45 mm rozstaw otworów puszek hinge cup drilling spacing межцентровое расстояние отверстий в чашке		C szuflada wysoka high drawer высокий ящик		przewodnica dolnego montażu under mount drawer направляющая нижнего монтажа
	montaż puszek na wkręty do drewna wood screw hinge cup mounting монтаж чашки на саморезы по дереву		regulacja pion i poziom vertical and horizontal adjustment регулировка по ширине и высоте		przewodnica kulkowa ball-bearing slide шариковая направляющая
	montaż przewodnika na wkręty do drewna wood screw mounting plate installation установка ответной планки на саморезы по дереву		opcja wypięcia release option снятие ящика без инструментов		przewodnica rolkowa roller slide роликовая направляющая
	montaż przewodnika na wkręty euro euro screw mounting plate installation установка ответной планки на евровинты		H=83 wysokość boku MB Square drawer side height MB Square высота боковой стенки MB Square		metalbox metalbox металбок
	montaż przewodnika na kolki dowel mount hinge монтаж чашки на саморезы с дюбелями		H=83 wysokość boku MB drawer side height MB высота боковой стенки MB		SLOW cichy domyk quiet shut бесшумное закрытие
	regulacja mimośrodowa eccentric adjustment эксцентриковая регулировка		H=95 wysokość boku AXIS drawer side height AXIS высота боковой стенки AXIS		SELF CLOSING samodociąg self closing доводчик
	x 100 pakowanie packing упаковка		3D dostępna bryła 3D 3D model available есть 3D модель		montaż nasuwany ze sprężynem push mounting with locking device надвижной монтаж с креплением фасада
	CLIP-ON sposób montażu clip-on clip-on mounting быстрый монтаж clip-on		CERTIFICATE 60,000 trwałość tested durability кол-во циклов откр./закрыт.		montaż nakładany put on mounting накладной монтаж



Oświetlenie meblowe Furniture lighting Мебельное освещение

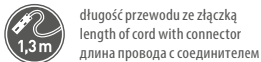
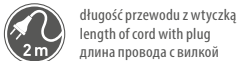
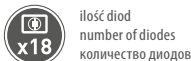
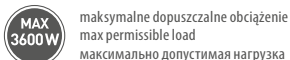
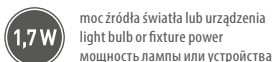
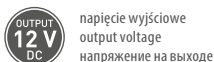
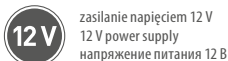
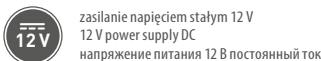
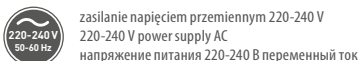
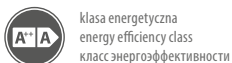



rodzaj złączki
type of connector
тип соединителя



rodzaj złączki
type of connector
тип соединителя



stopień ochrony IP
international protection marking
пылевлагозащита IP



współczynnik oddawania barw
colour rendering index
индекс цветопередачи



współczynnik mocy
power factor
коэффициент мощности



liczb cykli wł./wyt.
switching cycle
количество циклов вкл./выкл.



włącznik dotykowy ściemniający
dimnable touch switch
выключатель с регулятором яркости



oprawa z włącznikiem
fixture with switch
светильник с выключателем



sterowanie pilotem (IR/RF)
remote control (IR/RF)
управление с помощью пульта (ИР/РФ)



włącznik bezdotykowy dwubiegowy
two-pole touchless switch
бесконтактный переключатель / двухфункциональный



włącznik do szafy / jednobiegowy
single-pole touchless switch
переключатель для шкафов / однофункциональный



zasięg czujki ruchu
range of motion sensor
площадь действия сенсора



czas pracy
nominal lifetime
время работы



czas włączania
starting time (max)
время включения



trzonek źródła światła G4
base type G4
тип цоколя G4



temperatura pracy
working temperature
рабочая температура



gniazdo USB
USB port
USB – порт



maksymalne obciążenie gniazd USB
max load USB ports
максимальная нагрузка портов USB



gniazdo UK
UK socket
гнездо UK



ethernet
ethernet port
ethernet – порт



nie współpracuje ze ściemniaczami
non-dimmable
нет возможности подключения диммера



współpracuje ze ściemniaczami
dimmmable
есть возможность подключения диммера



montaż na ścianie / suficie
application: indoor / ceiling mounted
монтаж на стене / потолке



rekomendowana odległość montażu od powierzchni
recommended mounting distance from surfaces
рекомендуется монтаж устройства на расстоянии



średnica otworu montażowego
mounting hole diameter
монтажное отверстие диаметром



akumulator
battery
аккумулятор



Maksymalne obciążenie na jeden kanał
Maximum load per channel
Максимальная нагрузка на один канал



Częstotliwość pracy pilota
Remote control frequency
Частота работы пульта



Maksymalna rozpraszana moc źródeł światła dla profilu rozgrzanego do maksymalnie 65 stopni C, dla wersji z kloszem.
Maximal dissipated power of lamps for heated profiles to 65°C, when applied with lampshades.
Максимальная рассеиваемая мощность источников света для нагреваемого профиля до максимум 65°C, для версии с абажуром.

KOLORY
COLORS
ЦВЕТА



10
biały
white
белый



80
srebrny
silver
серебристый



14
antyczna miedź
antique copper
античная медь



10M
biały mat
white matt
белый матовый



7
antyczne srebro
antique silver
античное серебро



20
czarny
black
чёрный



mleczny
milk
молочный



19
szary mat
grey matt
серый матовый



20M
czarny mat
black matt
чёрный матовый



CS
kremowy
ecru
экрю



2, 52
satyna
satin
сатин



58
wenge
venge
венге



1, 40
chrom
chrome
хром



6, 51
stal szcztokowana
brushed steel
шлифованная сталь



3
mosiądz
brass
латунь



5, 53
aluminium
aluminium
алюминий



11
tytan szcztokowany
brushed titanium
шлифованный титан



4
antyczny mosiądz
antique brass
античная латунь



30
szary
gray
серый



12
czarny chrom
black chrome
чёрный хром



9
antyczny mosiądz
szcztokowany
antique brushed brass
античная шлифованная латунь



osunk
zink – plated
цинковка



13
tytan
titanium
титан



16
złoty mosiądz
golden brass
золотая латунь



22
kość stoniowa
ivory
слоновая кость



52
wiśnia
cherry
вишня



RZ
różowy
pink
розовый



17
brąz
bronze
коричневый



42
grusza
pear
груша



PM
pomarańczowy
orange
оранжевый



50
beż
beige
кремовый



30
brąz
brown
коричневый



15
miedź
copper
медь



7, 31, 732
ciemny brąz
dark brown
темно-коричневый



44
buk
beech
бук



61
ciemny mahoń
dark mahogany
темное красное дерево



41
olcha
alder
ольха



20, 48, 731
mahoń
mahogany
красное дерево



43
jasny brąz
light brown
светло-коричневый



NB
niebieski
blue
синий



51
calvados
calvados
кальвадос



ZL
zielony
green
зеленый

Klasa ochronności na pył, ciała stałe i wodę
Dust, solids & water ingress protection rating
Класс защиты от пыли, твердых тел и воды



IP	Stopień ochrony I Protection rating I Степень защиты I
0	Brak ochrony None Отсутствие защиты
1	Ochrona przed ciałami obcymi statycznymi o wielkości ponad 50 mm. Protection against ingress of > 50 mm bodies. Защита от попадания инородных твердых тел размером более 50 мм.
2	Ochrona przed ciałami stałymi przekraczającymi 12 mm. Protection against ingress of > 12 mm bodies. Защита от попадания инородных твердых тел размером более 12 мм.
3	Ochrona przed ciałami stałymi przekraczającymi 2,5 mm. Protection against ingress of > 2.5 mm bodies. Защита от попадания инородных твердых тел размером более 2,5 мм.
4	Ochrona przed ciałami stałymi przekraczającymi 1 mm. Protection against ingress of > 1 mm bodies. Защита от попадания инородных твердых тел размером более 1 мм.
5	Pyłoodporność Protection against ingress of dust Пылестойкость
6	Pyłoszczelność Dustproof Пылестойкость

IP	Stopień ochrony II Protection rating II Степень защиты II
0	Brak ochrony None Отсутствие защиты
1	Ochrona przed pionowo wpadającymi kroplami wody. Protection against dripping water (vertically falling drops). Защита от вертикально падающих капель воды.
2	Ochrona przed kroplami wody przy przechyleniu do 15°. Protection against dripping water when tilted up to 15°. Защита от капель воды, падающих под углом до 15°.
3	Ochrona przed rozpyloną wodą Protection against spraying water. Защита от распыленной воды.
4	Ochrona przed bryzgami wody Protection against splashing of water. Защита от брызг воды.
5	Ochrona przed strugami wody Protection against water jets Защита от струй воды
6	Ochrona przed falami Protection against powerful water jets (waves) Защита от волн
7	Ochrona przed zanurzeniem Protection against immersion Защита от погружения
8	Ochrona przed głębokim zanurzeniem Protection against deep immersion Защита от глубокого погружения

Klasa ochronności przed porażeniem elektrycznym

Electric shock protection class

Класс защиты от поражения электрическим током

Klasa bezpieczeństwa Safety class Класс безопасности	Symbol Symbol Символ	Wyjaśnienie Definition Пояснение
0	Brak None Нет Keine Nincs	<p>Ochronę przed porażeniem elektrycznym stanowi izolacja podstawowa. W przypadku uszkodzenia izolacji ochronę przeciwporażeniową powinny zapewnić odpowiednio korzystne warunki i środowiskowe oraz położenie urządzenia poza dotykem bezpośrednim.</p> <p>The protection against electric shock relies on basic insulation only. In the event of insulation failure, electric shock protection shall be assured by suitably favourable environmental conditions and locating the equipment beyond the reach of direct touch.</p> <p>Защиту от поражения электрическим током обеспечивает основная изоляция. В случае повреждения изоляции защиту от поражения электрическим током должны обеспечить соответствующие благоприятные условия окружающей среды и размещение оборудования вне зоны прямого контакта.</p>
I		<p>W urządzeniach z I klasą ochronności bezpieczeństwo zapewnione jest przez połączenie wszystkich czynnych przewodzących elementów z przewodem ochronnym lub bezpośrednio z uziemieniem.</p> <p>Class I equipment provides protection by connecting all live conductive parts to a protective wire or directly to earth.</p> <p>В устройствах с I классом защиты безопасность обеспечивается посредством объединения всех действующих проводящих элементов с защитным проводом или непосредственно с заземлением.</p>
II		<p>W urządzeniach z II klasą ochronności bezpieczeństwo zapewnione jest przez zastosowanie izolacji podwójnej lub wzmocnionej, której w danych warunkach środowiskowych i przy napięciu znamionowym uważa się nie do przebicia.</p> <p>Class II equipment provides protection by the use of double or strengthened insulation, which is deemed breakdown-proof under given environmental conditions at the rated voltage.</p> <p>В устройствах с II классом защиты безопасность обеспечивается путем применения двойной или усиленной изоляции, которая в данных условиях окружающей среды и при номинальном напряжении считается непробиваемой.</p>
III		<p>Ochrona przeciwporażeniowa w urządzeniach z III klasy ochronności jest zapewniona przez obniżenie napięcia zasilania do wartości bezpiecznej w danych warunkach środowiskowych.</p> <p>Class III equipment protection against electric shock is provided by reduction of power voltage to a safe limit under given environmental conditions.</p> <p>Защита от поражения электрическим током в устройствах с III классом защиты обеспечивается снижением напряжения питания до безопасного в данных условиях окружающей среды значения.</p>

Indeks

A

		A-HR18-300-10	504	A-LD10-300-90	499	A-LG10FL-300-05	500
A-B63-32	514	A-HR18-300-20M	504	A-LD10-405-05	499	A-LG10FL-300-10	500
A-B63-40	513	A-HR18-300-90	504	A-LD10-405-90	499	A-LG10FL-300-20M	500
A-BUDP-SET	520	A-HR18-300-90RA	503	A-LD10-600-05	499	A-LG10FL-300-90	500
A-BUD-UB	520	A-HR19-300-05	504	A-LD10-600-90	499	A-LG18-170-05	496
A-BUD-UG	520	A-HRS10-170-05	505	A-LD10FL-300-05	501	A-LG18-170-90	496
A-BUD-UM	520	A-HRS10-300-05	505	A-LD10FL-300-10	501	A-LG18-235-05	496
A-BUD-UP	520	A-HRS10-300-90	505	A-LD10FL-300-20M	501	A-LG18-235-90	496
A-BUD-UR	520	A-HRS10-405-05	505	A-LD10FL-300-90	501	A-LG18-300-05	496
A-C18-300-S-05	502, 517, 518	A-HRS10-600-05	505	A-LD18-170-05	497	A-LG18-300-10	496
A-C18-300-S-10	502	A-HRS18-170-05	504	A-LD18-170-90	497	A-LG18-300-20M	496
A-C18-300-S-20M	502	A-HRS18-170-90	504	A-LD18-235-05	497	A-LG18-300-90	496
A-C18-300-S-90	502	A-HRS18-235-05	504	A-LD18-235-90	497	A-LG18-405-05	496
A-DPG-16	507	A-HRS18-235-90	504	A-LD18-300-05	497	A-LG18-405-10	496
A-H16-300-05	502	A-HRS18-300-05	504	A-LD18-300-10	497	A-LG18-405-90	496
A-H16-300-90	502	A-HRS18-300-90	504	A-LD18-300-20M	497	A-LG18-600-05	496
A-H18-300-05	503	A-HRS18-405-05	504	A-LD18-300-90	497	A-LG18-600-90	496
A-H18-300-10	503	A-HRS18-405-90	504	A-LD18-405-05	497	A-LG19-300-05	497
A-H18-300-20M	503	A-HRS18-600-05	504	A-LD18-405-10	497	A-MEVO-170-05	494
A-H18-300-90	503	A-HRS18-600-90	504	A-LD18-405-90	497	A-MEVO-170-10A	494
A-HR10-235-05	505	A-K18-300-05	501	A-LD18-600-05	497	A-MEVO-170-20M	494
A-HR10-235-90	505	A-K18-300-10	501	A-LD18-600-90	497	A-MEVO-170-90	494
A-HR10-300-05	505	A-K18-300-20M	501	A-LD19-300-05	498	A-MEVO-235-05	494
A-HR10-300-10	505	A-K18-300-90	501	A-LG4MOV-300-05	499	A-MEVO-235-10A	494
A-HR10-300-90	505	A-KLP-4	512	A-LG10-170-05	498	A-MEVO-235-20M	494
A-HR10-405-05	505	A-KLP-4-20	512	A-LG10-235-05	498	A-MEVO-235-90	494
A-HR10-405-90	505	A-KR-4	511	A-LG10-235-90	498	A-MEVO-300-05	494
A-HR10-600-05	505	A-KR-4-20	511	A-LG10-300-05	498	A-MEVO-300-10A	494
A-HR10-600-90	505	A-LD4MOV-300-05	500	A-LG10-300-10	498	A-MEVO-300-20M	494
A-HR10FL-300-05	505	A-LD10-170-05	499	A-LG10-300-20M	498	A-MEVO-300-90	494
A-HR10FL-300-10	505	A-LD10-235-05	499	A-LG10-300-90	498	A-MEVO-405-05	494
A-HR10FL-300-20M	505	A-LD10-235-90	499	A-LG10-405-05	498	A-MEVO-405-10	494
A-HR10FL-300-90	505	A-LD10-300-05	499	A-LG10-405-90	498	A-MEVO-405-20M	494
A-HR18-300-05	504	A-LD10-300-10	499	A-LG10-600-05	498	A-MEVO-405-90	494
A-HR18-300-05RA	503	A-LD10-300-20M	499	A-LG10-600-90	498	A-MITO-PLUS	516

A-MPRO-170-05	496	A-R10FORM-270-90	491	A-RD-MITO	516	A-TDEVO2-235-05	495
A-MPRO-170-10	496	A-R10NOV-270-05	491	A-RNOV2-270-05	487	A-TDEVO2-235-90	495
A-MPRO-170-20M	496	A-R10NOV-270-10	491	A-RNOV2-270-10	487	A-TDEVO2-300-05	495
A-MPRO-170-90	496	A-R10NOV-270-20M	491	A-RNOV2-270-20M	487	A-TDEVO2-300-90	495
A-MPRO-235-05	496	A-R10NOV-270-90	491	A-RNOV2-270-90	487	A-TDEVO2-405-05	495
A-MPRO-235-10	496	A-R10TORO-270-05	492	A-SG-MITO	516	A-TDEVO2-405-90	495
A-MPRO-235-20M	496	A-R10TORO-270-90	492	A-SN-ADSET	517, 518	A-TDEVO2-600-05	495
A-MPRO-235-90	496	A-R10TRAFO-270-05	491	A-SN-FSET	517	A-TDEVO2-600-90	495
A-MPRO-300-05	496	A-R10TRAFO-270-90	491	A-SN-HSET1	518	A-TDEVO-170-05	494
A-MPRO-300-10	496	A-R16ERG-220-05	486	A-SN-K19-270-05	517, 518	A-TDEVO-170-10	494
A-MPRO-300-20M	496	A-R16ERG-230-50	486	A-SN-LOFT-200-20MN	521	A-TDEVO-170-20M	494
A-MPRO-300-90	496	A-R16ERG-270-50	486	A-SN-POZ	518	A-TDEVO-170-90	494
A-MPRO-405-05	496	A-R16ERG-270-90	486	A-SN-R19RIV-270-05	517, 518	A-TDEVO-235-05	494
A-MPRO-405-10	496	A-R18CARO-270-05	488	A-SN-SDP-TU	519	A-TDEVO-235-10	494
A-MPRO-405-20M	496	A-R18CARO-270-90	488	A-SN-SOFT-25	517, 518	A-TDEVO-235-20M	494
A-MPRO-405-90	496	A-R18COTE-270-05	489	A-SN-SOFT-40	517, 518	A-TDEVO-235-90	494
A-MSOFT-ADAPT	515	A-R18COTE-270-90	489	A-SN-TDS-405-00	517	A-TDEVO-300-05	494
A-MSOFT-RAMA	514	A-R18ERG-270-05	486	A-SN-TDT-405-00	518	A-TDEVO-300-10	494
A-PG-18	506	A-R18ERG-270-20M	486	A-SN-TG-405-00	517, 518	A-TDEVO-300-20M	494
A-PGR-10	506	A-R18ERG-270-90	486	A-SO-48X4	510	A-TDEVO-300-90	494
A-PGR-10S	507	A-R18GE02-270-05	486	A-SO-48X4-20	510	A-TDEVO-405-05	494
A-PGR-18	506	A-R18LOCA-305-05	490	A-SO-145X4	510	A-TDEVO-405-10	494
A-POZ-MITO	516	A-R18LOCA-305-90	490	A-SO-145X4-10	510	A-TDEVO-405-20M	494
A-PTD	509	A-R18NERO-270-05	489	A-SO-145X4-20	510	A-TDEVO-405-90	494
A-PTG	509	A-R18NERO-270-10	489	A-SOFT-30	514	A-TDEVO-600-05	494
A-PW-RC-DOC	515	A-R18NERO-270-20M	489	A-SOFT-30Z	514	A-TDEVO-600-10	494
A-R4MOV-270-05	490	A-R18NERO-270-90	489	A-SOFT-50	514	A-TDEVO-600-20M	494
A-R10ARCO-270-05	492	A-R18NOVS-270-05	487	A-SOFT-50Z	514	A-TDEVO-600-90	494
A-R10ARCO-270-90	492	A-R18NOVS-270-10	487	A-SP-7X12	511	A-TDPRO-170-05	495
A-R10FALDA-270-05	492	A-R18NOVS-270-20M	487	A-SP-48X7	510	A-TDPRO-170-10	495
A-R10FALDA-270-90	492	A-R18NOVS-270-90	487	A-SP-48X12	511	A-TDPRO-170-20M	495
A-R10FL-270-05	490	A-R18VIS-270-05	488	A-T18-300-05	502	A-TDPRO-170-90	495
A-R10FL-270-10	490	A-R18VIS-270-20M	488	A-T18-300-10	502	A-TDPRO-235-05	495
A-R10FL-270-20M	490	A-R18VIS-270-90	488	A-T18-300-90	502	A-TDPRO-235-10	495
A-R10FL-270-90	490	A-R19NERO-300-05	489	A-TDEVO2-170-05	495	A-TDPRO-235-20M	495
A-R10FORM-270-05	491	A-R19NOVS-300-05	488	A-TDEVO2-170-90	495	A-TDPRO-235-90	495

A-TDPRO-300-05	495	A-TMITO-250-00	516	AE-BPW3S100U-53	615	AE-PBC3GS-53BKS	622
A-TDPRO-300-10	495	A-TMITO-250-05	516	AE-BPW3U60-20	618	AE-PBC3GU-10	619
A-TDPRO-300-20M	495	A-TMITO-300-00	516	AE-BPW3U60-80	618	AE-PBC3GU-20	619
A-TDPRO-300-90	495	A-TMITO-300-05	516	AE-BPW3U60U-20	618	AE-PBC3GU-51BK	622
A-TDPRO-405-05	495	A-USZCZ-CHM4	513	AE-BPW3U60U-80	618	AE-PBC3GU-53	619
A-TDPRO-405-10	495	A-USZCZ-CHM4-20	513	AE-BPW3U100U-53	615	AE-PBKT3S2U-80	623
A-TDPRO-405-20M	495	A-USZCZ-TDEVO2	513	AE-BPW4F120P-10	606	AE-PBKT3U2U-80	623
A-TDPRO-405-90	495	A-USZCZ-U4	512	AE-BPW4F120P-20	606	AE-PBKT4S-80	623
A-TDPRO-600-05	495	A-WD-EVO2	507	AE-BPW4S100-53	615	AE-PBKT4U-80	623
A-TDPRO-600-10	495	A-WD-PRO	508	AE-BPW4S120P-10	606	AE-PBSC3GS-10	620
A-TDPRO-600-20M	495	A-WDR-EVO	508	AE-BPW4S120P-20	606	AE-PBSC3GS-20N	620
A-TDPRO-600-90	495	A-WDR-PRO	509	AE-BPW4U100-53	615	AE-PBSC3GS-53	620
A-TG-170-05	493	A-ZAC-WDEVO2	508	AE-PB1FAVA-10	612	AE-PBSC3GU-10	620
A-TG-170-10	493	A-ZAT-TDEVO2	512	AE-PB1FAVA-20	612	AE-PBSC3GU-20N	620
A-TG-170-20M	493	AE-BPW1FACP-10	604	AE-PB1FAVA-53	612	AE-PBSC3GU-53	620
A-TG-170-90	493	AE-BPW1FACP-20	604	AE-PB1FAVAP-10	610	AE-PBSUC2GS-10	620
A-TG-235-05	493	AE-BPW1S1UCH-51	615	AE-PB1FAVAP-20	610	AE-PBSUC2GS-20N	620
A-TG-235-10	493	AE-BPW1S1UCH-53	614	AE-PB1FAVAP-53	610	AE-PBSUC2GS-53	620
A-TG-235-20M	493	AE-BPW1S2UCH-80	614	AE-PB1SAVA-10	612	AE-PBSUC2GU-10	620
A-TG-235-90	493	AE-BPW1SACP-10	604	AE-PB1SAVA-20	612	AE-PBSUC2GU-20N	620
A-TG-300-05	493	AE-BPW1SACP-20	604	AE-PB1SAVA-53	612	AE-PBSUC2GU-53	620
A-TG-300-10	493	AE-BPW1U1UCH-51	615	AE-PB1SAVAP-10	610	AE-PBU02GS-10	619
A-TG-300-20M	493	AE-BPW1U1UCH-53	614	AE-PB1SAVAP-20	610	AE-PBU02GS-20	619
A-TG-300-90	493	AE-BPW1U2UCH-80	614	AE-PB1SAVAP-53	610	AE-PBU2GU-10	619
A-TG-405-05	493	AE-BPW2FCAM-10	608	AE-PB2FPRES-10	602	AE-PBU2GU-20	619
A-TG-405-10	493	AE-BPW2FCAM-20	608	AE-PB2FPRES-20	602	AE-PBU2GU-53	619
A-TG-405-20M	493	AE-BPW2SCAM-10	608	AE-PB2FPRES-53	602	AE-WBBUNI-10DIM	590
A-TG-405-90	493	AE-BPW2SCAM-20	608	AE-PB2SPRES-10	602	AE-WBCUNI-10DIM	590
A-TG-600-05	493	AE-BPW3GS-20	616	AE-PB2SPRES-20	602	AE-WBEZDB-10S	588
A-TG-600-10	493	AE-BPW3GS-80	616	AE-PB2SPRES-53	602	AE-WBEZDC-10S	588
A-TG-600-20M	493	AE-BPW3GU-20	616	AE-PB03GS-10	619	AE-WBEZDK15-10	588
A-TG-600-90	493	AE-BPW3GU-80	616	AE-PB03GS-20	619	AE-WBEZD-NB	591
A-TG-BUD-200-00	520	AE-BPW3S60-20	618	AE-PB03GS-53	619	AE-WBEZDPIR2-20	589
A-TG-BUD-300-00	520	AE-BPW3S60-80	618	AE-PB03GU-53	619	AE-WBEZDPIR-10	589
A-TMITO-200-00	516	AE-BPW3S60U-20	618	AE-PBC3GS2U-53BKS	622	AE-WDBP1-10N	586
A-TMITO-200-05	516	AE-BPW3S60U-80	618	AE-PBC3GS-51BK	622	AE-WDBP1-20N	586

AE-WDBP2CCT-10N	586	AM-ODB000-60	104	GP-0728-J4-C-04	386	GZ-NORD-1-18	349
AE-WDBP2CCT-20N	586	AM-OWM-DL-GM-10	106	GP-0728-J4-R	386	GZ-NORD-1-20M	349
AE-WDSB-10DIM	590	AM-OWM-DL-GM-30	106	GS-BERGA-1-01	363	GZ-OLBIA-1-04	394
AE-WDSC-10DIM	590	AM-OWM-DL-GM-60	106	GS-BERGA-1-02	363	GZ-PALER-1-07	388
AE-WLB01-10	592	AM-OWM-DL-MG-10	106, 107	GS-BERGA-1-05	363	GZ-POINT-1-06	354
AE-WLC01-20	592	AM-OWM-DL-MG-30	106	GS-BERGA-1-06	363	GZ-POINT-1-18	354
AE-WLIP44-15	593	AM-OWM-DL-MG-60	106	GS-BERGA-1-10	363	GZ-ROYAL3-1-10-03	396
AE-WLLAN1-10	594	AM-OWM-KR-GM-10	106	GS-BERGA-1-12	363	GZ-SONET-1-07	401
AE-WLLAN1-20	594	AM-OWM-KR-GM-30	106	GS-BERGA-1-20M	363	GZ-SONET-1-18	401
AE-WLLAN1-90	594	AM-OWM-KR-GM-60	106	GS-BERGA-1-90	363	GZ-SONET-1-20M	401
AE-WLPR-60	592	AM-OWM-KR-MG-10	106	GZ-71C024-01	402	GZ-SPOT-1-06	336
AE-WLPR-60P2	592	AM-OWM-KR-MG-30	106	GZ-ARDEA-1-09	391	GZ-SPOT-1-18	336
AE-WLSZN1-10	594	AM-OWM-KR-MG-60	106	GZ-CENTO-1-04	400	GZ-SPOT-1-20M	336
AE-WPDRW-00	591	AM-PLA-DLU-0	107	GZ-CENTO-1-07	400	GZ-TERNI-1-01	343, 364
AE-ZLADLUX-40	601	AM-PL-DL-MAG	107	GZ-CENTO-1-14	400	GZ-TERNI-1-02	364
AE-ZLADPOD-20	601	AMR-BP-0715	109	GZ-CENTO-1-20M	400	GZ-TERNI-1-05	364
AE-ZUSB-20	600	AMR-BP-1003	109	GZ-CRPA20-01	405	GZ-TERNI-1-06	364
AM-ADAP0A-10	105	AM-ZAT-A1-10	109	GZ-CRPA25-01	405	GZ-TERNI-1-09	364
AM-ADAP0A-60	105			GZ-CRPA30-01	405	GZ-TERNI-1-10	364
AM-ADAP0B-10	105	B		GZ-CRPA30-03	405	GZ-TERNI-1-12	364
AM-ADAP0B-60	105	BP-SLZIGW-10	451	GZ-CRPA30-A1	405	GZ-TERNI-1-15	364
AM-KRZYZ-KPL	104	BP-SLZIGW-21	451	GZ-CRPA40-01	405	GZ-TERNI-1-16	364
AM-MBSOFT-P2	161			GZ-CRPB20-01	406	GZ-TERNI-1-20M	364
AM-OAM-DL-GM-10	108	E		GZ-CRPB25-01	406	GZ-UDINE-1-01	364
AM-OAM-DL-GM-30	108	EM-SBL065-01-A	228	GZ-CRPB25-A1	406	GZ-UDINE-1-02	364
AM-OAM-DL-GM-60	108	EM-SBL100-01-A	228	GZ-CRPB30-01	406	GZ-UDINE-1-05	364
AM-OAM-DL-MG-10	108	EM-SBL150-01-A	228	GZ-CRPB30-03	406	GZ-UDINE-1-06	364
AM-OAM-DL-MG-30	108			GZ-CRPB30-A1	406	GZ-UDINE-1-10M	364
AM-OAM-DL-MG-60	108	G		GZ-CRPB40-01	406	GZ-UDINE-1-12N	364
AM-OAM-KR-GM-10	108	GA-IMPER-1-02B	402	GZ-CRPB40-A1	406	GZ-UDINE-1-20M	364
AM-OAM-KR-GM-30	108	GA-IMPER-1-11	402	GZ-CRPC30-01	406	GZ-VENICE-1-20M	350
AM-OAM-KR-GM-60	108	GA-IMPER-1-20M	402	GZ-LORENA-1-18	355	GZ-VENICE-1-90	350
AM-OAM-KR-MG-10	108	GA-STRUCTURE-1-20M	358	GZ-LORENA-1-20M	355	GZ-WP1136-04	397
AM-OAM-KR-MG-30	108	GP-0728-J4-A-04	386	GZ-LORENA-1-21	355	GZ-WP1148-04	398
AM-OAM-KR-MG-60	108	GP-0728-J4-A-07	386	GZ-MILAN-32-20M	331	GZ-WP1152-04	398
AM-ODB000-10	104	GP-0728-J4-B	386	GZ-NORD-1-03	349	GZ-WP1155-01	365

GZ-ZH-011-05A	365	KM-00-50-D20	476	KM-RD-75-CF-20	480	KO-SR200-40-OC	273
		KM-0H-40-D20	476	KM-RD-75-SF	480	KO-SR200-50-10	273
		KM-0H-50-D20	476	KM-RD-75-SF-20	480	KO-SR200-50-OC	273
HB-USB-4X-60	303	KM-015030-10	476	KM-SPAIN-40MM-18	481	KO-SR200-60-10	273
		KM-015030-20	476	KM-SPAIN-50MM-18	481	KO-SR200-60-OC	273
		KM-015038-10	476	KO-150B0-01	294	KO-UMC450-01	293
ID-GZ-CRPJ30-01	407	KM-015038-GM	477	KO-150B0-60	294	KO-UMC450-60	293
ID-GZ-CRPJ40-01	407	KM-A035MM-00	477	KO-150B0-E-01	297	KO-WMC450-01	292
ID-RS-E-15696-20M	366	KM-A035MM-30	477	KO-200B0-01	294	KO-WMC450-60	292
ID-RS-E-188128-20M	366	KM-A050MM-00	478	KO-200B0-60	294	KT-WP1147-04	399
ID-RS-E-220160-06	366	KM-A050MM-30	478	KO-200B0-E-01	297	KW-FS0125-01	220
ID-RS-E-220160-20M	366	KM-AH35MM-00	477	KO-300B0-01	296	KW-FS0140-01	220
ID-RS-E-272192-06	366	KM-AH35MM-30	477	KO-300B0-60	296	KW-FS0335-01	221
ID-RS-E-272192-20M	366	KM-AH50MM-00	478	KO-400B0-01	296	KW-FS0350-01	221
ID-RS-E-304224-06	366	KM-AH50MM-30	478	KO-400B0-60	296	KW-FS0375-01	221
ID-RS-E-304224-20M	366	KM-B050MM-00	478	KO-500B0-01	296	KW-FS0425-03	221
ID-RS-E-336256-06	366	KM-B050MM-30	478	KO-500B0-60	296	KW-FS0450-03	221
ID-RS-E-336256-20M	366	KM-B075MM-00	479	KO-SR100-30-10	273	KW-FS0650-01	222
ID-RS-E-368288-06	366	KM-B075MM-30	479	KO-SR100-30-OC	273		
ID-RS-E-368288-20M	366	KM-BH50MM-00	478	KO-SR100-40-10	273	L	
ID-RS-E-400320-06	366	KM-BH50MM-30	478	KO-SR100-40-OC	273	LB-80X100-05	304
ID-RS-E-400320-20M	366	KM-BH75MM-00	479	KO-SR100-50-10t	273	LB-80X100-20	304
		KM-BH75MM-30	479	KO-SR100-50-OC	273	LB-80X160-05	305
		KM-GREYROLL-50mm-BH481		KO-SR100-60-10	273	LB-80X160-20	305
KK-D50-80-06	316	KM-GREYROLL-50mm-ZH481		KO-SR100-60-OC	273	LB-80X280-05	305
KK-D50100-06	316	KM-GREYROLL-75mm-BH481		KO-SR150-30-10	273	LB-80X280-20	305
KK-W60245-M0	315	KM-GREYROLL-75mm-ZH481		KO-SR150-30-OC	273	LB-80X500-05	306
KK-W60245-M1	315	KM-RD-35-CF	479	KO-SR150-40-10	273	LB-80X500-20	306
KK-W60245-M2	315	KM-RD-35-CF-20	479	KO-SR150-40-OC	273	LB-K80X80-05	304
KK-W60245-M6	315	KM-RD-35-SF	479	KO-SR150-50-10	273	LB-K80X80-20	304
KK-W60800-M0	317	KM-RD-35-SF-20	479	KO-SR150-50-OC	273	LD-3SKL-CBN	573
KK-W60800-M1	317	KM-RD-50-CF	480	KO-SR150-60-10	273	LD-3SKL-NBN	573
KK-W80800-D0	317	KM-RD-50-CF-20	480	KO-SR150-60-OC	273	LD-3SKL-ZBN	573
KK-W80800-D1	317	KM-RD-50-SF	480	KO-SR200-30-10	273	LD-2835-24V-300-20-CB	528
KK-W80800-D2	317	KM-RD-50-SF-20	480	KO-SR200-30-OC	273	LD-2835-24V-300-20-NE4	528
KM-00-40-D20	476	KM-RD-75-CF	480	KO-SR200-40-10	273	LD-2835-24V-300-20-ZB	528

LD-2835-24V-600-20-CB	528	LD-3528-300-20-ZB-50	528	LD-CS36CB-53	564	LD-TR24CB-53	567
LD-2835-24V-600-20-NE4	528	LD-3528-300-65-CB	526	LD-CS36NE-53	564	LD-TR24NE-53	567
LD-2835-24V-600-20-ZB	528	LD-3528-300-65-NE4	526	LD-CS36ZB-53	564	LD-TR24ZB-53	567
LD-2835-60-60-20-CCT	527	LD-3528-300-65-ZB	526	LD-DIMLED-10	593	LD-UNF-12V6X12-6X	531
LD-2835-300-20-CB	526	LD-3528-600-20-CB	526	LD-IRUSB-53	571	LD-VA24CB-53	563
LD-2835-300-20-CB-50	528	LD-3528-600-20-CB-50	528	LD-KABE2M-00	595	LD-VA24NE-53	563
LD-2835-300-20-CBN	526	LD-3528-600-20-NE4	526	LD-KLPCB-00N	572	LD-VA24ZB-53	563
LD-2835-300-20-NE4N	526	LD-3528-600-20-NE4-50	528	LD-KLPNB-00N	572	LD-VE15CB-53N	566
LD-2835-300-20-NE4P	526	LD-3528-600-20-ZB	526	LD-KLPZB-00N	572	LD-VE15CBZB-53N	567
LD-2835-300-20-NE4P-50	528	LD-3528-600-20-ZB-50	528	LD-KONMINI-RGB	580	LD-VE15NE-53N	566
LD-2835-300-20-ZB	526	LD-3528-600-65-CB	526	LD-KONML-AD	584	LD-VE15ZB-53N	566
LD-2835-300-20-ZB-50	528	LD-3528-600-65-NE4	526	LD-KONML-MONO	581	LD-WL2457-53	569
LD-2835-300-20-ZBN	526	LD-3528-600-65-ZB	526	LD-KONML-MONO-PAN	582	LD-WZA20W-NW	577
LD-2835-300-65-CB	526	LD-5050-300-20-CB	527	LD-KONML-MONO-PIL	581	LD-WZA36W-NW	577
LD-2835-300-65-CBN	526	LD-5050-300-20-NE4	527	LD-KONML-RGBW	582	LD-WZA60W-NW	577
LD-2835-300-65-NE4N	526	LD-5050-300-20-NE4-50	528	LD-KONML-RGBW-PIL	583	LD-WZA80W-NW	577
LD-2835-300-65-ZB	526	LD-5050-300-20-ZB	527	LD-KONML-WIFI	584	LD-WZA150W-NW	577
LD-2835-300-65-ZBN	526	LD-5050-300-65-CB	527	LD-KONML-WRGB-PAN	583	LD-Z3CSCB-53	568
LD-2835-600-5MM-20-CB	527	LD-5050-300-65-NE4	527	LD-KWP27CB-53	569	LD-ZAC6WDE-RGB	579
LD-2835-600-5MM-20-NE4527		LD-5050-300-65-ZB	527	LD-KWP27ZB-53	569	LD-ZAS09WEC-30	573
LD-2835-600-5MM-20-ZB	527	LD-5630-300-20-CB	527	LD-LU16CB-53	564	LD-ZAS15WEC-30	573
LD-2835-600-20-CB	526	LD-5630-300-20-NE4	527	LD-LU16NE-53	564	LD-ZAS20WEC-30	573
LD-2835-600-20-NE4	526	LD-5630-300-20-NE4-50	528	LD-LU16ZB-53	564	LD-ZAS24PR080W-30	574
LD-2835-600-20-ZB	526	LD-5630-300-20-ZB	527	LD-NF12V6x12-65-CB	531	LD-ZAS30WEC-30	573
LD-2835-600-65-CB	526	LD-5630-300-65-CB	527	LD-NF12V6x12-65-NE	531	LD-ZAS60WEC-30	573
LD-2835-600-65-NE4	526	LD-5630-300-65-NE4	527	LD-NF12V6x12-65-ZB	531	LD-ZAS75W-30	574
LD-2835-600-65-ZB	526	LD-5630-300-65-ZB	527	LD-OBP27CB-53	568	LD-ZAS150-NW	576
LD-3014-1200-20-CB	527	LD-AL24CB-53	566	LD-OBP27ZB-53	568	LD-ZAS350-NW	577
LD-3014-1200-20-NE4	527	LD-AL24NE-53	566	LD-OPD5W0-CB	570	LD-ZASNF-12V6X12-65	531
LD-3014-1200-20-ZB	527	LD-AL24ZB-53	566	LD-OPD9W0-CB	570	LD-ZASPR007W-30	576
LD-3528-300-20-CB	526	LD-BOS1CBWG-53	572	LD-PIRUSB-53	571	LD-ZASPR012W-30	576
LD-3528-300-20-CB-50	528	LD-CHIC16NE-10DIM	571	LD-RA60CB-40N	570	LD-ZASPR016W-30	576
LD-3528-300-20-NE4P	526	LD-CHIC16NE-20DIM	571	LD-RA60ZB-40N	570	LD-ZASPR024W-30	576
LD-3528-300-20-NE4P-50	528	LD-COB12V-20-CB	530	LD-RGB-150-20	527	LD-ZASPR033W-30	576
LD-3528-300-20-NI	526	LD-COB12V-20-NE	530	LD-RGB-150-65	527	LD-ZASPR054W-30	576
LD-3528-300-20-ZB	526	LD-COB12V-20-ZB	530	LD-RGBW-300-20	527	LD-ZASPR065W-30	576

LD-ZASPRO80W-30	576	LMB-KAT38-05	234	MG-MENSA-010	232	MR-RDRO-0000	236
LD-ZASPU15W-30N	578	LMB-KAT38-20M	234	MG-MENSA-030	232	MR-RS025-001	237
LD-ZL5RGB150-00	527, 529	LMB-SZCZ38-05	235	MM-FI20X6X7-PL10-A-1T	228	MR-SPG-UNI-GAL	123
LD-ZSKL15-00N	578	LMB-SZCZ38-20M	235	MM-FI20X6X7-PL20-A-1T	228	MR-SPG-UNI-OC	123
LD-ZTK8MM-02N	598	LO-00-00-001	233	MM-FI20X6X7-PL30-A-1T	228	MR-T1824-KPL	244
LD-ZTK8MM-02N600	598	LO-00-00-003	233	MM-FI20X6X7-PL80-A-1T	228	MR-TDL011-01	215
LD-ZTK10MM-02N	598	LO-M2M-00-125	227	MM-FI20X6X7-ZN-A-1T	228	MR-TH001-01	248
LD-ZTKS8MM-02N	600	LZ-AKZ312-10N	596	MP-054350-10	159	MR-TH002-L01	248
LD-ZTKT8MM-02N	598	LZ-AKZ612-10N	597	MP-054400-10	159	MR-TH002-P01	248
LD-ZTKT8MM-02N600	598	LZ-KA2MM-10	595	MP-054450-10	159	MR-TH004-001	243
LD-ZTKT10MM-02N	598	LZ-KAPR2M-10	596	MP-054450-80	159	MR-TH005-001	242
LD-ZTKTRGB-04N	598			MP-054500-10	159	MR-TH009-001	245
LD-ZTL8MM-02N	597	M		MP-054500-80	159	MR-TH010-001	246
LD-ZTL8MM-02N600	597	MA-MATA-1-10	202	MP-086270-10	159	MR-TH011-001	245
LD-ZTL8MMAMP-02N	599	MA-MATA-1-20	202	MP-086300-10	159	MR-TH016-001	242
LD-ZTL8MMAMP-02N600	599	MA-MATA-1-60	202	MP-086350-10	159	MR-TH018-KPL	243
LD-ZTL10MM-02N	597	MC-J01A-12-01	212	MP-086350-80	159	MR-TH018-L01	249
LD-ZTL82M-2N	599	MC-J01A-12-06	212	MP-086400-10	159	MR-TH018-P01	249
LD-ZTL82M-2N600	599	MC-J01A-16-01	212	MP-086400-80	159	MR-TH019-001	250
LD-ZTL102M-2N	599	MC-J01A-16-06	212	MP-086450-10	159	MR-TH019-003	250
LD-ZTLRGB2M-4N	599	MC-J04A2-14-01	213	MP-086450-80	159	MR-TH024-KPL	244
LD-ZTLRGB-04N	597	MC-J04A2-14-05	213	MP-086500-10	159	MR-TH035-KPL	246
LD-ZTLS8MM-02N	600	MC-J04A2-18-01	213	MP-086500-80	159	MR-TH048-001	251
LD-ZTLS8MMAMP-02N	600	MC-J04A2-22-01	213	MP-086550-10	159	MR-THA12-001	240
LD-ZTLS82M-2N	600	MC-J60A27-01	213	MP-118350-10	159	MR-THB12-001	241
LD-ZWND6W-10	579	MC-J62-01	214	MP-118400-10	159	MR-THQZ1-001	249
LD-ZWND12-10	579	MC-J63-05	210	MP-118450-10	159	MR-WP-010-01	239
LD-ZZAS07PROKD6	575	MC-J65-08-01	211	MP-118500-10	159	MR-WP-011-01	240
LD-ZZAS12PROKD6	575	MC-J65-08-05	211	MP-150270-10	159	MR-WP013-001	241
LD-ZZAS16PROKD6	575	MC-J65-10-01	211	MP-150300-10	159	MR-WP-14-KPL	247
LD-ZZAS24PROKD6	575	MC-J65-10-05	211	MP-150350-10	159	MR-WP-15-KPL	247
LD-ZZAS33PROKD6	575	MC-J65-12-01	211	MP-150400-10	159	MR-WP-028-01	236
LMB-BOCZ38L-05	233	MC-J65-12-05	211	MP-150450-10	159	MR-WP2802-01	252
LMB-BOCZ38L-20M	233	MC-J123-01	211	MP-150500-10	159	MR-WP2804-01	253
LMB-BOCZ38P-05	233	MC-J123-05	211	MP-150550-10	159	MR-WP2806-01	253
LMB-BOCZ38P-20M	233	MC-K135-06-01	212	MR-R0050-001	238	MR-WP2807-20	254

MR-WP2815-01	252	NM-A60870-80N*	459	NM-BD-001-M1B	446	NM-F50710-10	463
MR-WPS01-001	255	NM-A61100-01	459	NM-BD-003-01	438	NM-F50710-20	463
MR-WPS03-001	255	NM-A61100-02	459	NM-BD-003-02	438	NM-F50870-01	463
MR-WPZ002-01	238	NM-A61100-05	459	NM-BD-100-01	439	NM-F50870-06	463
MR-WPZ003-01	239	NM-A61100-06	459	NM-BD-100-02	439	NM-F50870-10	463
MR-WPZ006-01	251	NM-A61100-10N*	459	NM-BD-100-05	439	NM-F50870-20	463
MR-WPZ023-01	254	NM-A61100-20	459	NM-BD-100-06	439	NM-G60710-01N	461
MR-ZSL011-01	215	NM-A80710-01	460	NM-BD-150-01	438	NM-G60710-02N	461
		NM-A80710-02	460	NM-BD-150-02	438	NM-G60710-05N	461
		NM-A80710-03	460	NM-BD-712-M1	446	NM-G60710-06N	461
NM-46R710-05	469	NM-A80710-05	460	NM-BD727-100	444	NM-G60710-10N	461
NM-46R820-05	469	NM-A80710-06	460	NM-BD-739-05	444	NM-G60710-20N	461
NM-60R710-05	469	NM-A80710-10	460	NM-BD-762-01	440	NM-G60710-80N	461
NM-60R710-06	469	NM-A80710-20	460	NM-BD-762-05	440	NM-G60820-01N	461
NM-60R710-20	469	NM-A80710-80	460	NM-BD-780-M1	439	NM-G60820-05N	461
NM-60R820-05	469	NM-A80870-01	460	NM-BD-780-M2	439	NM-G60820-06N	461
NM-A60710-01	459	NM-A80870-02	460	NM-BD-780-M5	439	NM-G60820-10N*	461
NM-A60710-02	459	NM-A80870-03	460	NM-BD867-100	440	NM-G60820-20N	461
NM-A60710-05	459	NM-A80870-05	460	NM-BD868-100	441	NM-G61100-01N	461
NM-A60710-06	459	NM-A80870-06	460	NM-BD868-150	441	NM-G61100-20N	461
NM-A60710-10N	459	NM-A80870-10	460	NM-BD869-150	441	NM-INDUSTRIA-H20-710X	
NM-A60710-20	459	NM-A80870-20	460	NM-DAK27-060	445	820-20M	470
NM-A60710-80N	459	NM-A80870-80	460	NM-DAK27-080	445	NM-INDUSTRIA-H40-710X	
NM-A60820-01	459	NM-ARTO-10-2R304-20M	468	NM-DAK27-100	445	820-20M	470
NM-A60820-02	459	NM-ARTO-10-2R406-20M	468	NM-DAK27-120	445	NM-INDUSTRIA-P20-710X	
NM-A60820-05	459	NM-ARTO-10-2R711-20M	468	NM-DAK27-150	445	820-20M	472
NM-A60820-06	459	NM-ARTO-10-3R304-20M	466	NM-DAP77-60	442	NM-INDUSTRIA-P40-710X	
NM-A60820-10N*	459	NM-ARTO-10-3R406-20M	466	NM-DAP77-100	442	820-20M	472
NM-A60820-20	459	NM-ARTO-10-3R711-20M	466	NM-DAP77-150	442	NM-INDUSTRIA-P80-710X	
NM-A60820-80N	459	NM-ARTO-12-2R304-20M	468	NM-DPA20-100	454	820-20M	472
NM-A60870-01*	459	NM-ARTO-12-2R406-20M	468	NM-DPA20-100W	454	NM-INDUSTRIA-T20-710X	
NM-A60870-02*	459	NM-ARTO-12-2R711-20M	468	NM-DPA20-150	454	820-20M	473
NM-A60870-05*	459	NM-ARTO-12-3R304-20M	466	NM-DPA20-150W	454	NM-INDUSTRIA-T40-710X	
NM-A60870-06*	459	NM-ARTO-12-3R406-20M	466	NM-DPD20-100	453	820-20M	473
NM-A60870-10N*	459	NM-ARTO-12-3R711-20M	466	NM-F50710-01	463	NM-INDUSTRIA-X20-710X	
NM-A60870-20*	459	NM-BAHIA40-150-01	442	NM-F50710-06	463	820-20M	474
						NM-INDUSTRIA-X40-710X	

820-20M	474	NM-STGY135-150-01	447	OC-A0660-06	298	PA-GLAXKT-AL	560
NM-INDUSTRIA-X80-710X		NM-STOMP-100-01	448	OC-A0680-06	298	PA-GLAXMIC3M-AL	545
820-20M	474	NM-STOMP-120-10	448	OC-E0707D-CZ	301	PA-GLAXMIC-AL	545
NM-KL-DPA-20	455	NM-STOMP-120-20	448	OM-OBK150-20B	318	PA-GLAXMICNK3M-AL	541
NM-KL-DPL-20	454	NM-STOMP-130-01	448	OM-OBK175-20	318	PA-GLAXMICNK-AL	541
NM-MDN926-01	449	NM-STOMP-130-06	448	OM-OBO300-05	318	PA-GLAXMNBWDW3M19-AL	553
NM-MDN927-01	449	NM-STOMP-130-20	448	OM-OBO400-05	318	PA-GLAXMNBWDW3M-AL	553
NM-MDN941-01	450	NM-STOMP-150-01	448			PA-GLAXMNBWJW3M19-AL	552
NM-MDN-D4-01	448	NM-STOMP-160-01	448	P		PA-GLAXMNBWJW3M-AL	552
NM-MLA-50-75	455	NM-STOMP-160-06	448	PA-0241-35-50	378	PA-GLAXMNK3M-AL	542
NM-MLA-65-85	456	NM-STOMP-160-20	448	PA-0242-35-50	378	PA-GLAXMNK3M-AL-10	542
NM-MLA-85-125	456	NM-STOPKA-M6	452	PA-0242-35-50-06	378	PA-GLAXMNK3M-AL-20M	542
NM-MLA-95-145	457	NM-STOPKSZESTK-M6	452	PA-0242-35-50-20M	378	PA-GLAXMNK-AL	542
NM-MLA-125-195	457	NM-WPJ22-D20	450	PA-0243-35-50	379	PA-GLAXMNK-AL-10	542
NM-MLA-KL	458	NM-X-LINE40710-01	464	PA-0243-35-50-06	379	PA-GLAXMNK-AL-20M	542
NM-MUFAWB-00	453	NM-X-LINE40710-10	464	PA-0243-35-50-20M	379	PA-GLAXMNK-AL-90	542
NM-MUFAWK-00	453	NM-X-LINE40710-20	464	PA-CPGLAXAH-00	532, 534,	PA-GLAXMNKW-AL	544
NM-NACK27651-06	445			536, 538, 540		PA-GLAXMNKW-AL-10	544
NM-S60710-01A	462	O		PA-CPGLAXAV-00	532, 534,	PA-GLAXMNKW-AL-20M	544
NM-S60710-02A	462	OC-2PV340-02-18	299	536, 538, 540		PA-GLAXMNKW-AL-90	544
NM-S60710-05A	462	OC-2PV345-02-18	299	PA-CPGLAXL-00	532, 534,	PA-GLAXMPK-AL	554
NM-S60710-06A	462	OC-2PV350-02-18	299	536, 538, 540		PA-GLAXMW-AL	547
NM-S60710-10A	462	OC-2PV360-02-18	299	PA-GLAX3M-AL	546	PA-GLAXMW-AL-10	547
NM-S60710-20A	462	OC-2PV360-02-18A	299	PA-GLAX3M-AL-10	546	PA-GLAXMW-AL-20M	547
NM-S60820-01A	462	OC-2PV370-02-18	299	PA-GLAX3M-AL-20M	546	PA-GLAXMW-AL-90	547
NM-S60820-02A	462	OC-2PV380-02-18	299	PA-GLAX-AL	546	PA-GLAXNBD3M16-AL	558
NM-S60820-05A	462	OC-2PV380-02-18A	299	PA-GLAX-AL-10	546	PA-GLAXNBD3M19-AL	558
NM-S60820-06A	462	OC-2PV390-02-18	299	PA-GLAX-AL-20M	546	PA-GLAXNBD3M-AL	558
NM-S60820-10A	462	OC-A0150-06	298	PA-GLAX-AL-90	546	PA-GLAXNBDW3M16-AL	559
NM-S60820-20A	462	OC-A0160-06	298	PA-GLAXDR-AL	548	PA-GLAXNBDW3M19-AL	559
NM-SQ40ADJ-060	443	OC-A0170-06	298	PA-GLAXGKL3M-00C	532	PA-GLAXNBDW3M-AL	559
NM-SQ40ADJ-100	443	OC-A0180-06	298	PA-GLAXGKS3M-00C	534	PA-GLAXNB3M16-AL	556
NM-SQA100-01	443	OC-A0190-06	298	PA-GLAXGKW3M-00C	536	PA-GLAXNB3M19-AL	556
NM-SQA150-01	443	OC-A0350K-06	300	PA-GLAXGKWK3M-00C	538	PA-GLAXNB3M-AL	556
NM-STGY135-100-01	447	OC-A0450-06	300	PA-GLAXGKZK3M-00C	540	PA-GLAXNBWJW3M16-AL	557
NM-STGY135-130-01	447	OC-A0460D-06	301	PA-GLAXKT3M-AL	560	PA-GLAXNBWJW3M19-AL	557

PA-GLAXNBW3M-AL	557	PA-OSMLGLAXMO-00	542	PA-VELLO-L4M-05	380	PA-ZASGLAXNKKT-10	551
PA-GLAXNK3M-AL	543	PA-OSMLGLAXM03M-00	532,	PA-VELLO-L4M-06	380	PA-ZASGLAXNKKT-20M	551
PA-GLAXNK-AL	543	534, 536, 538, 540		PA-VELLO-L4M-10	380	PA-ZASGLAXNKKT-90	551
PA-GLAXNKKT3M-AL	551	PA-OSMLGLAXSO-00	549	PA-VELLO-L4M-20	380	PA-ZASGLAXNKKTT-00	551
PA-GLAXNKKT3M-AL-10	551	PA-OSMLGLAXT-00	551	PA-VELLO-TD3M-05	385	PA-ZASGLAXRAD-00	549
PA-GLAXNKKT3M-AL-20M551		PA-OSMLGLAXT3M-00	532,	PA-VELLO-TD3M-06	385	PA-ZASVELLO-CN-05	382
PA-GLAXNKKT-AL	551	534, 536, 538, 540		PA-VELLO-TD3M-10	385	PA-ZASVELLO-CN-06	382
PA-GLAXNKKT-AL-10	551	PA-OSTRGLAX-00	543,	PA-VELLO-TD3M-20M	385	PA-ZASVELLO-CN-10	382
PA-GLAXNKKT-AL-20M	551	546, 548, 549, 550, 551,		PA-VELLO-TJ3M-05	384	PA-ZASVELLO-CN-20M	382
PA-GLAXNKKT-AL-90	551	555, 560, 561		PA-VELLO-TJ3M-06	384	PA-ZASVELLO-CP-05	382
PA-GLAXRAD-AL	549	PA-OSTRGLAX3M-00	543,	PA-VELLO-TJ3M-10	384	PA-ZASVELLO-CP-06	382
PA-GLAXREG1-AL	555	546, 550, 551, 556, 557,		PA-VELLO-TJ3M-20M	384	PA-ZASVELLO-LNL-05	380
PA-GLAXREG2-AL	555	558, 559, 560		PA-ZASGLAX-00	546	PA-ZASVELLO-LNL-06	380
PA-GLAXWN3M-AL	550	PA-OSTRGLAXM-00	542,	PA-ZASGLAX-10	546	PA-ZASVELLO-LNL-10	380
PA-GLAXWN3M-AL-06	550	544, 547, 554		PA-ZASGLAX-20M	546	PA-ZASVELLO-LNL-20M	380
PA-GLAXWN3M-AL-10	550	PA-OSTRGLAXM3M-00	542,	PA-ZASGLAX-90	546	PA-ZASVELLO-LNP-05	380
PA-GLAXWN3M-AL-20M	550	552, 553		PA-ZASGLAXDR-00	548	PA-ZASVELLO-LNP-06	380
PA-GLAXWN16-AL	550	PA-ROZGLAX-53	548	PA-ZASGLAXKT-00	560	PA-ZASVELLO-LNP-10	380
PA-GLAXWN19-AL	550	PA-ROZGLAXP-53	548	PA-ZASGLAXMIC-00	545	PA-ZASVELLO-LNP-20M	380
PA-GLAXWN-AL	550	PA-SPRGLAXM-00	542, 544,	PA-ZASGLAXMICNK-00	541	PA-ZASVELLO-LPL-05	380
PA-GLAXWPKT-AL	561	549		PA-ZASGLAXMNK-00	542	PA-ZASVELLO-LPL-06	380
PA-OSMLGLAX-00	543,	PA-SPRGLAXMIC-00	541, 551	PA-ZASGLAXMNK-20M	542	PA-ZASVELLO-LPL-10	380
546, 548, 549, 550, 551,		PA-USZGLAX-00N	550	PA-ZASGLAXMNK-90	542	PA-ZASVELLO-LPL-20M	380
555, 560, 561		PA-USZGLAX-10N	550	PA-ZASGLAXMNK-00	542	PA-ZASVELLO-LPP-05	380
PA-OSMLGLAX3M-00543, 546,		PA-VELLO-C3M-05	382	PA-ZASGLAXMNKO-00	542	PA-ZASVELLO-LPP-06	380
550, 551, 556, 557, 558,		PA-VELLO-C3M-06	382	PA-ZASGLAXMNKW-00	544	PA-ZASVELLO-LPP-10	380
559, 560		PA-VELLO-C3M-10	382	PA-ZASGLAXMNKW-10	544	PA-ZASVELLO-LPP-20M	380
PA-OSMLGLAXM-00	542, 544,	PA-VELLO-C3M-20M	382	PA-ZASGLAXMNKW-20M	544	PA-ZASVELO-CP-10	382
547, 554		PA-VELLO-C4M-05	382	PA-ZASGLAXMNKW-90	544	PA-ZASVELO-CP-20M	382
PA-OSMLGLAXM3M-00	532,	PA-VELLO-C4M-06	382	PA-ZASGLAXMW-00	547	PA-ZAWGLAXDR-00	548, 549
534, 536, 538, 540, 542,		PA-VELLO-C4M-10	382	PA-ZASGLAXMW-10	547	PA-ZGLAXKTOMZ-00	563
552, 553		PA-VELLO-C4M-20M	382	PA-ZASGLAXMW-20M	547	PA-ZGLAXMNKOMZ-00	562
PA-OSMLGLAXMIC-00N	541,	PA-VELLO-L3M-05	380	PA-ZASGLAXMW-90	547	PA-ZGLAXOMZ-00	562
545		PA-VELLO-L3M-06	380	PA-ZASGLAXMWK-00	547	PB-0FPO18-250	130
PA-OSMLGLAXMIC3M-00N		PA-VELLO-L3M-10	380	PA-ZASGLAXNK-00	543	PB-0FPO18-300	130
541, 545		PA-VELLO-L3M-20M	380	PA-ZASGLAXNKKT-00	551	PB-0FPO18-350	130
PA-OSMLGLAXMK-00	542, 547						
PA-OSMLGLAXMK3M-00	532,						
534, 536, 538, 540							

PB-0FPO18-400	130	PB-45-002010-60A	281	PB-AXISPRO-KPL350D1	164	PB-AXISPRO-RELKW350-10
PB-0FPO18-450	130	PB-45-MF2X15-60A	285	PB-AXISPRO-KPL400A	163	169
PB-0FPO18-500	130	PB-45-MF002X20-60A283, 287		PB-AXISPRO-KPL400A1	163	PB-AXISPRO-RELKW400 169
PB-0FPO18-550	130	PB-45-MF2X34-60A	288	PB-AXISPRO-KPL400B	163	PB-AXISPRO-RELKW400-10
PB-0FPO18-600	130	PB-45-MF202X10-60A	283	PB-AXISPRO-KPL400B1	163	169
PB-0SHX-250-A	126	PB-45-MF342X17-60A	288	PB-AXISPRO-KPL400C	164	PB-AXISPRO-RELKW450 169
PB-0SHX-270-A	126	PB-91024160V	289	PB-AXISPRO-KPL400C1	164	PB-AXISPRO-RELKW450-10
PB-0SHX-300-A	126	PB-91104100B5-A	290	PB-AXISPRO-KPL400D	164	169
PB-0SHX-350-A	126	PB-91114100B5-A	290	PB-AXISPRO-KPL400D1	164	PB-AXISPRO-RELKW500 169
PB-0SHX-400-A	126	PB-91164100B5-A	290	PB-AXISPRO-KPL450A	163	PB-AXISPRO-RELKW500-10
PB-0SHX-450-A	126	PB-91634100B5V-A	290	PB-AXISPRO-KPL450A1	163	169
PB-0SHX-500-A	126	PB-91644100B5V-A	290	PB-AXISPRO-KPL450B	163	PB-AXISPRO-RELKW550 169
PB-0SHX-550-A	126	PB-93004162601	290	PB-AXISPRO-KPL450B1	163	PB-AXISPRO-RELKW550-10
PB-0SHX-600-A	126	PB-AXISPRO-KPL69-450-10		PB-AXISPRO-KPL450C	164	169
PB-3D0SHX18-250-PRO	124	165		PB-AXISPRO-KPL450C1	164	PB-AXISPRO-WEWMOCA 165
PB-3D0SHX18-300-H	125	PB-AXISPRO-KPL69-450-60		PB-AXISPRO-KPL450D	164	PB-AXISPRO-WEWMOCA1165
PB-3D0SHX18-300-PRO	124	165		PB-AXISPRO-KPL450D1	164	PB-AXISPRO-WEWMOCB 166
PB-3D0SHX18-350-H	125	PB-AXISPRO-KPL69-500-10		PB-AXISPRO-KPL500A	163	PB-AXISPRO-WEWMOCB1166
PB-3D0SHX18-350-PRO	124	165		PB-AXISPRO-KPL500A1	163	PB-AXISPRO-WEWMOCC 166
PB-3D0SHX18-400-H	125	PB-AXISPRO-KPL69-500-60		PB-AXISPRO-KPL500B	163	PB-AXISPRO-WEWMOCC1166
PB-3D0SHX18-400-PRO	124	165		PB-AXISPRO-KPL500B1	163	PB-AXISPRO-WEWMOCD 167
PB-3D0SHX18-450-H	125	PB-AXISPRO-KPL300A	163	PB-AXISPRO-KPL500C	164	PB-AXISPRO-WEWMOCD1167
PB-3D0SHX18-450-PRO	124	PB-AXISPRO-KPL300A1	163	PB-AXISPRO-KPL500C1	164	PB-AXISPRO-ZESWEW-A1
PB-3D0SHX18-500-H	125	PB-AXISPRO-KPL300B	163	PB-AXISPRO-KPL500D	164	AXISPRO 167
PB-3D0SHX18-500-PRO	124	PB-AXISPRO-KPL300B1	163	PB-AXISPRO-KPL500D1	164	PB-AXISPRO-ZESWEW-A
PB-3D0SHX18-550-H	125	PB-AXISPRO-KPL300C	164	PB-AXISPRO-KPL550A	163	AXISPRO 167
PB-3D0SHX18-550-PRO	124	PB-AXISPRO-KPL300C1	164	PB-AXISPRO-KPL550A1	163	PB-AXISPRO-ZESWEW-B1
PB-3D0SHX18-600-PRO	124	PB-AXISPRO-KPL300D	164	PB-AXISPRO-KPL550B	163	AXISPRO 168
PB-45-002X15-60A	284	PB-AXISPRO-KPL300D1	164	PB-AXISPRO-KPL550B1	163	PB-AXISPRO-ZESWEW-B
PB-45-002X20-60A	282	PB-AXISPRO-KPL350A	163	PB-AXISPRO-KPL550C	164	AXISPRO 168
PB-45-0010X3-60A	281	PB-AXISPRO-KPL350A1	163	PB-AXISPRO-KPL550C1	164	PB-AXISPRO-ZESWEW-C1
PB-45-202X10-60A	282, 286	PB-AXISPRO-KPL350B	163	PB-AXISPRO-KPL550D	164	AXISPRO 168
PB-45-400MF-2X16-60A	280	PB-AXISPRO-KPL350B1	163	PB-AXISPRO-KPL550D1	164	PB-AXISPRO-ZESWEW-C
PB-45-450-2X20-60A	286	PB-AXISPRO-KPL350C	164	PB-AXISPRO-RELKW300	169	AXISPRO 168
PB-45-450MF202X10-60A	287	PB-AXISPRO-KPL350C1	164	PB-AXISPRO-RELKW300-10		PB-AXISPRO-ZESWEW-D1
PB-45-600MF-2X27-60A	289	PB-AXISPRO-KPL350D	164	169		AXISPRO 169
				PB-AXISPRO-RELKW350	169	PB-AXISPRO-ZESWEW-D

AXISPRO	169	PB-D-KPL250A1	183	PB-D-KPL550A1	183	PB-D-REL2500	185
PB-D-BXSIDE45B	192	PB-D-KPL250B	184	PB-D-KPL550B	184	PB-D-REL3000	185
PB-D-BXSIDE45B-10	192	PB-D-KPL250B1	184	PB-D-KPL550B1	184	PB-D-REL3500	185
PB-D-BXSIDE45C	193	PB-D-KPL250C	184	PB-D-KPL550C	184	PB-D-REL4000	185
PB-D-BXSIDE45C-10	193	PB-D-KPL250C1	184	PB-D-KPL550C1	184	PB-D-REL4500	185
PB-D-BXSIDE50B	192	PB-D-KPL300A	183	PB-D-LR-00-0	190	PB-D-REL5000	185
PB-D-BXSIDE50B-10	192	PB-D-KPL300A1	183	PB-D-LR-00-10	190	PB-D-REL5500	185
PB-D-BXSIDE50C	193	PB-D-KPL300B	184	PB-D-MATRYCA	181, 195	PB-D-RELCOV	190
PB-D-BXSIDE50C-10	193	PB-D-KPL300B1	184	PB-D-MBSTAB-00	197	PB-D-RELCOV-10	190
PB-D-BXSIDEKW25C	178	PB-D-KPL300C	184	PB-D-MHG04	196	PB-D-RELKW350	172
PB-D-BXSIDEKW25C-10	178	PB-D-KPL300C1	184	PB-D-MHG04-KW	180	PB-D-RELKW350-10	172
PB-D-BXSIDEKW30C	178	PB-D-KPL350A	183	PB-D-N2R0-00	179, 193	PB-D-RELKW400	172
PB-D-BXSIDEKW30C-10	178	PB-D-KPL350A1	183	PB-D-N2R0-01	179, 193	PB-D-RELKW400-10	172
PB-D-BXSIDEKW35C	178	PB-D-KPL350B	184	PB-D-P20250A	183	PB-D-RELKW450	172
PB-D-BXSIDEKW35C-10	178	PB-D-KPL350B1	184	PB-D-P20300A	183	PB-D-RELKW450-10	172
PB-D-BXSIDEKW40C	178	PB-D-KPL350C	184	PB-D-P20300C	184	PB-D-RELKW500	172
PB-D-BXSIDEKW40C-10	178	PB-D-KPL350C1	184	PB-D-P20350A	183	PB-D-RELKW500-10	172
PB-D-BXSIDEKW45C	178	PB-D-KPL400A	183	PB-D-P20350C	184	PB-D-RELKW550	172
PB-D-BXSIDEKW45C-10	178	PB-D-KPL400A1	183	PB-D-P20400A	183	PB-D-RELKW550-10	172
PB-D-BXSIDEKW50C	178	PB-D-KPL400B	184	PB-D-P20400C	184	PB-D-RP-1100	188
PB-D-BXSIDEKW50C-10	178	PB-D-KPL400B1	184	PB-D-P20450A	183	PB-D-RP-1100-10	188
PB-D-BXSIDEKW55C	178	PB-D-KPL400C	184	PB-D-P20450C	184	PB-D-S2R0-00	179, 194
PB-D-BXSIDEKW55C-10	178	PB-D-KPL400C1	184	PB-D-P20500A	183	PB-D-S2R0-01	179, 194
PB-D-CONBXSID	191	PB-D-KPL450A	183	PB-D-P20500C	184	PB-D-UCHWEW	189
PB-D-CONBXSIDE-10	191	PB-D-KPL450A1	183	PB-D-P20550C	184	PB-D-UCHWEW-10	189
PB-D-CONREL	191	PB-D-KPL450B	184	PB-D-P20STAB	161	PB-D-ULE-500	198
PB-D-CONREL-10	191	PB-D-KPL450B1	184	PB-D-PRZEGLP	192	PB-D-W2R0-00	180, 194
PB-D-CONREL-KW	176	PB-D-KPL450C	184	PB-D-PRZEGLP-10	192	PB-D-W2R0-01	180, 194
PB-D-CONREL-KW-10	176	PB-D-KPL450C1	184	PB-D-PRZEGLP-KW	177	PB-D-WEWMOCA	185
PB-D-D2R0-00	177, 195	PB-D-KPL500A	183	PB-D-PRZEGLP-KW-10	177	PB-D-WEWMOCA1	185
PB-D-D2R0-01	177, 195	PB-D-KPL500A1	183	PB-D-REL300-10	185	PB-D-WEWMOCA-KW	173
PB-D-KPL68-450-10	197	PB-D-KPL500B	184	PB-D-REL350-10	185	PB-D-WEWMOCA-KW-10	173
PB-D-KPL68-450-80	197	PB-D-KPL500B1	184	PB-D-REL400-10	185	PB-D-WEWMOCB	186
PB-D-KPL68-500-10	197	PB-D-KPL500C	184	PB-D-REL450-10	185	PB-D-WEWMOCB1	186
PB-D-KPL68-500-80	197	PB-D-KPL500C1	184	PB-D-REL500-10	185	PB-D-WEWMOCB-KW	173
PB-D-KPL250A	183	PB-D-KPL550A	183	PB-D-REL550-10	185	PB-D-WEWMOCB-KW-10	173

PB-D-WEWMOCC	187	PB-KW-KPL250A	171	PB-KW-KPL550A	171	PD-GAM060-N10	113
PB-D-WEWMOCC1	187	PB-KW-KPL250A1	171	PB-KW-KPL550A1	171	PD-GAM060-N60	113
PB-D-WEWMOCC-KW	174	PB-KW-KPL250B	171	PB-KW-KPL550B	171	PD-GAM080-N02	113
PB-D-WEWMOCC-KW-10	174	PB-KW-KPL250B1	171	PB-KW-KPL550B1	171	PD-GAM080-N10	113
PB-D-WEWORG-A	188	PB-KW-KPL250C	172	PB-KW-KPL550C	172	PD-GAM080-N60	113
PB-D-WEWORG-A-10	188	PB-KW-KPL250C1	172	PB-KW-KPL550C1	172	PD-GAM100-N02	113
PB-D-WEWORG-B	188	PB-KW-KPL300A	171	PB-KW-KPL600A	171	PD-GAM100-N10	113
PB-D-WEWORG-B-10	188	PB-KW-KPL300A1	171	PB-KW-KPL600A1	171	PD-GAM100-N60	113
PB-D-WEWORGKW-A	175	PB-KW-KPL300B	171	PB-KW-KPL600B	171	PD-GAM120-N02	113
PB-D-WEWORGKW-A-10	175	PB-KW-KPL300B1	171	PB-KW-KPL600B1	171	PD-GAM120-N10	113
PB-D-WEWORGKW-B	176	PB-KW-KPL300C	172	PB-KW-KPL600C	172	PD-GAM120-N60	113
PB-D-WEWORGKW-B-10	176	PB-KW-KPL300C1	172	PB-KW-KPL600C1	172	PD-GAM150-N02	113
PB-D-WEWSZKLC	186	PB-KW-KPL350A	171	PB-SZABLON-AXIS-MB	103,	PD-GAM150-N10	113
PB-D-WEWSZKLC-10	186	PB-KW-KPL350A1	171	199		PD-GAM150-N60	113
PB-D-ZESWEW-C	187	PB-KW-KPL350B	171	PB-WSPCOK	129	PD-GNE012-50-10M	112
PB-D-ZESWEW-C-10	187	PB-KW-KPL350B1	171	PD-ECGDL-060	122	PD-GNE012-50-60	112
PB-D-ZESWEWKW-C	174	PB-KW-KPL350C	172	PD-ECGDL-080	122	PD-GNE012-60-10M	112
PB-D-ZESWEWKW-C-10	174	PB-KW-KPL350C1	172	PD-ECGDL-150	122	PD-GNE012-60-60	112
PB-D-ZLE-450	198	PB-KW-KPL400A	171	PD-G0050-N02	114	PD-GNE012-80-10M	112
PB-D-ZLE-500	198	PB-KW-KPL400A1	171	PD-G0050-N03	115	PD-GNE012-80-60	112
PB-D-ZNACZ-0	181, 196	PB-KW-KPL400B	171	PD-G0060-N02	114	PD-GPD01-001	117
PB-D-ZR-00-0	189	PB-KW-KPL400B1	171	PD-G0060-N03	115	PD-GPD02-002	117
PB-D-ZR-00-10	189	PB-KW-KPL400C	172	PD-G0080-N02	114	PD-GPD03-005	117
PB-D-ZR-KW-00	175	PB-KW-KPL400C1	172	PD-G0080-N03	115	PD-LIFTNEW-LIGHT-10	110
PB-D-ZR-KW-10	175	PB-KW-KPL450A	171	PD-G0100-N02	114	PD-LIFTNEW-LIGHT-80	110
PB-G10HX300-H	131	PB-KW-KPL450A1	171	PD-G0100-N03	115	PD-LIFTNEW-MEDIUM-10110	
PB-G10HX-350	131	PB-KW-KPL450B	171	PD-G0120-N02	114	PD-LIFTNEW-MEDIUM-80110	
PB-G10HX-450	131	PB-KW-KPL450B1	171	PD-G0120-N03	115	PD-LIFTNEW-STRONG-10110	
PB-G10HX-500	131	PB-KW-KPL450C	172	PD-G0150-N02	114	PD-LIFTNEW-STRONG-80110	
PB-G10HX-550	131	PB-KW-KPL450C1	172	PD-G0150-N03	115	PD-LIFTNEW-STRONG-PLUS-10	
PB-GCHX18-300-H	127	PB-KW-KPL500A	171	PD-G60160-02	116	110	
PB-GCHX18-350-H	127	PB-KW-KPL500A1	171	PD-G80160-02	116	PD-LIFT-P20-LIGHT-10	110
PB-GCHX18-400-H	127	PB-KW-KPL500B	171	PD-GAM050-N02	113	PD-LIFT-P20-LIGHT-80	110
PB-GCHX18-450-H	127	PB-KW-KPL500B1	171	PD-GAM050-N10	113	PD-LIFT-P20-MEDIUM-10110	
PB-GCHX18-500-H	127	PB-KW-KPL500C	172	PD-GAM050-N60	113	PD-LIFT-P20-MEDIUM-80110	
PB-GCHX18-550-H	127	PB-KW-KPL500C1	172	PD-GAM060-N02	113	PD-LIFT-P20-STRONG-10110	

PD-LIFT-P20-STRONG-80110		PG-ST6083-10A	264	PK-0-H45-350	141	PK-0H45350GX2	147
PD-LIFT-P20-STRONG-		PG-ST6083-20	278	PK-0-H45-400	141	PK-0H45350GX2-A	148
-PLUS-10	110	PG-ST6083-60	264	PK-0-H45-450	141	PK-0H45350HK	146
PD-LIFT-P20-STRONG-		PG-ST83115-10	278	PK-0-H45-500	141	PK-0H45400GX1	145
-PLUS-80	110	PG-ST83115-10A	264	PK-0-H45-550	141	PK-0H45400GX2	147
PD-MDLIFT-P1-D	120	PG-ST83115-60	264	PK-0-H45-600	141	PK-0H45400GX2-A	148
PD-MDLIFT-P2-D	121	PG-ST8311520	278	PK-0-H45-700	141	PK-0H45400HK	146
PD-MD-ZB-01-KPL	103	PK-0-000-027	154	PK-0-H53-300	132	PK-0H45450GX1	145
PD-MD-ZB-04-KPL	103	PK-0H27-3000	153	PK-0-H53-350	132	PK-0H45450GX2	147
PD-MINILIFTNEW-LIGHT	111	PK-0H27-3500	153	PK-0-H53-400	132	PK-0H45450GX2-A	148
PD-MINILIFTNEW-LIGHT-20		PK-0H27-4000	153	PK-0-H53-450	132	PK-0H45450HK	146
111		PK-0H27-4500	153	PK-0-H53-500	132	PK-0H45500GX1	145
PD-MINILIFTNEW-MEDIUM		PK-0H27-5000	153	PK-0-H53-550	132	PK-0H45500GX2	147
111		PK-0H30-2500	151	PK-0-H53-600	132	PK-0H45500GX2-A	148
PD-MINILIFTNEW-MEDIUM-20		PK-0H30-2500-A	152	PK-0-H53-650	132	PK-0H45500HK	146
111		PK-0H30-3000	151	PK-0-H53-700	132	PK-0H45550GX1	145
PD-MINILIFTNEW-STRONG		PK-0H30-3000-A	152	PK-0-H53-750	132	PK-0H45550GX2	147
111		PK-0H30-3500	151	PK-0-H53-800	132	PK-0H45550GX2-A	148
PD-MINILIFTNEW-STRONG-20		PK-0H30-3500-A	152	PK-0-H53-900	132	PK-0H45550HK	146
111		PK-0H30-4000	151	PK-0-H53-1000	132	PK-0H45600GX1	145
PD-PD000-001	118	PK-0H30-4000-A	152	PK-0-H53-1100	132	PK-0H45600GX2	147
PD-PD000-001B	119	PK-0H30-4500	151	PK-0H17182XP	155	PK-0H45600GX2-A	148
PG-AL4560-20	278	PK-0-H35-2500	149	PK-0H17214XP	155	PK-0H45600HK	146
PG-AL6083-20	278	PK-0-H35-2500L	150	PK-0H17246XP	155	PK-0H45650GX1	145
PG-AL8311520	278	PK-0-H35-3000	149	PK-0H17278XP	155	PK-0H45650GX2	147
PG-GA4560-10	277	PK-0-H35-3000L	150	PK-0H17310XP	155	PK-0H45650GX2-A	148
PG-GA4560-20	277	PK-0-H35-3500	149	PK-0H17342XP	155	PK-0H45650HK	146
PG-GA6083-10	277	PK-0-H35-3500L	150	PK-0H17406XP	155	PK-0H45700GX1	145
PG-GA6083-20	277	PK-0-H35-4000	149	PK-0H17438XP	155	PK-0H45700GX2	147
PG-GA83115-10	277	PK-0-H35-4000L	150	PK-0H45250GX1	145	PK-0H45700GX2-A	148
PG-GA8311520	277	PK-0-H35-4500	149	PK-0H45250HK	146	PK-0H45700HK	146
PG-ST4560-10	278	PK-0-H35-4500L	150	PK-0H45300GX1	145	PK-0H45750HK	146
PG-ST4560-10A	264	PK-0-H35-5000	149	PK-0H45300GX2	147	PK-L-H45-250	136
PG-ST4560-20	278	PK-0-H35-5000L	150	PK-0H45300GX2-A	148	PK-L-H45-250-A	138
PG-ST4560-60	264	PK-0-H45-250	141	PK-0H45300HK	146	PK-L-H45-300	136
PG-ST6083-10	278	PK-0-H45-300	141	PK-0H45350GX1	145	PK-L-H45-300-A	138

PK-L-H45-300-GX	139	PK-PRO-H45-400	142	PM-PLFI60-30	307	PP-LUK-00-01	217
PK-L-H45-350	136	PK-PRO-H45-450	142	PM-PLFI60-43	307	PP-LUK-00-02	217
PK-L-H45-350-A	138	PK-PRO-H45-500	142	PM-PLFI60-45	307	PP-LUK-00-05	217
PK-L-H45-350-GX	139	PK-PRO-H45-550	142	PM-PLFI60-47	307	PP-MP0055-01	203
PK-L-H45-400	136	PK-PRO-H45-600	142	PM-PLFI60-49	307	PP-MP0055-02	203
PK-L-H45-400-A	138	PK-PRO-H45-650	142	PM-PLFI60-50	307	PP-MP0055-05	203
PK-L-H45-400-GX	139	PK-S-H45-250	140	PM-PLFI60-51	307	PP-MP0055-06	203
PK-L-H45-450	136	PK-S-H45-300	140	PP-00GS02-01	204	PP-NEO-20M	434
PK-L-H45-450-A	138	PK-S-H45-350	140	PP-00GS02-02	204	PP-NW09X90B	216
PK-L-H45-450-GX	139	PK-S-H45-400	140	PP-00GS02-05	204	PP-NW10X100B	216
PK-L-H45-500	136	PK-S-H45-450	140	PP-00GS02-06	204	PP-NW10X145B	216
PK-L-H45-500-A	138	PK-S-H45-500	140	PP-00GS03-01	205	PP-NW12X120B	216
PK-L-H45-500-GX	139	PK-S-H45-550	140	PP-00GS03-02	205	PP-NW14X120B	216
PK-L-H45-550	136	PK-S-H45-600	140	PP-00GS03-05	205	PP-NW14X140B	216
PK-L-H45-550-A	138	PK-S-H45-650	140	PP-00GS03-06	205	PP-NW14X165B	216
PK-L-H45-550-GX	139	PK-S-H45-700	140	PP-00GS04-01	205	PP-P04570-20	276
PK-L-H45-600	136	PM-LBFI60-01	306	PP-00GS04-02	205	PP-P80110-20	276
PK-L-H45-600-A	138	PM-LBFI60-02	306	PP-00GS04-05	205	PP-PMONT0D-22	223
PK-L-H45-600-GX	139	PM-LBFI60-05	306	PP-00GS04-06	205	PP-PMONT0M-01	222
PK-L-P20-H45-300	134	PM-LBFI60-06	306	PP-BAR-20M	436	PP-PMONT0M-07	222
PK-L-P20-H45-350	134	PM-LBFI80-01	306	PP-BELT-20M	430	PP-PMONT0M-08	222
PK-L-P20-H45-400	134	PM-LBFI80-02	306	PP-DP0105-06	204	PP-PMONT0M-22	222
PK-L-P20-H45-450	134	PM-LBFI80-05	306	PP-DP0105-01	204	PP-ROD-20M	436
PK-L-P20-H45-500	134	PM-LBFI80-06	306	PP-DP0105-02	204	PP-S0L003-01T	208
PK-L-P20-H45-550	134	PM-NAR1004-10	224	PP-DP0105-05	204	PP-S0L012-01T	209
PK-L-P20-H45-600	134	PM-NAR1004-11	224	PP-FLAT-20M	430	PP-SMART-000	216
PK-P-H45-300-GX	144	PM-NAR1004-19	224	PP-GALA-20M	432	PP-SP0075-01	203
PK-P-H45-350-GX	144	PM-PFMH50-24	232	PP-GINO-20M	432	PP-SP0075-02	203
PK-P-H45-400-GX	144	PM-PFMH50-25	232	PP-GL-A48-01	206	PP-SP0075-05	203
PK-P-H45-450-GX	144	PM-PFMH51-10	232	PP-GL-B48-01	206	PP-SP0075-06	203
PK-P-H45-500-GX	144	PM-PFMH55-25	232	PP-GL-CGP-01	207	PP-SPL001-01	215
PK-P-H45-550-GX	144	PM-PFMH61-10	232	PP-GL-DR5-01	214	PP-TREE-20M	437
PK-P-H45-600-GX	144	PM-PFMH64-25	232	PP-GL-E410-01	207	PP-WIRE-20M	437
PK-PRO-H45-250	142	PM-PLFI60-05	307	PP-HS0006-01	209	PR-0B-250-10	156
PK-PRO-H45-300	142	PM-PLFI60-10	307	PP-HS2710-01	210	PR-0B-250-18	156
PK-PRO-H45-350	142	PM-PLFI60-20	307	PP-INGRID-20M	434	PR-0B-300-10	156

PR-0B-300-10-Z	157	RR-CH-OW-000	235	RS-400320-01	366	UA-00-337096	345
PR-0B-300-18	156	RS-156096-01	366	RS-400320-02	366	UA-00-337096-20M	345
PR-0B-350-10	156	RS-156096-02	366	RS-400320-05	366	UA-00-337128	345
PR-0B-350-10-Z	157	RS-156096-05	366	RS-400320-06	366	UA-00-337128-20M	345
PR-0B-350-18	156	RS-156096-06	366	RS-400320-14	366	UA-00-337160	345
PR-0B-350-18-Z	157	RS-156096-14	366	RS-SZ-400-10	160	UA-00-337160-20M	345
PR-0B-400-10	156	RS-188128-01	366	RS-SZ-450-10	160	UA-00-337192	345
PR-0B-400-10-Z	157	RS-188128-02	366	RS-SZ-500-10	160	UA-00-337192-20M	345
PR-0B-400-18	156	RS-188128-05	366	RS-TRIES-96-06	368	UA-00-337224	345
PR-0B-450-10	156	RS-188128-06	366	RS-TRIES-128-06	368	UA-00-337224-20M	345
PR-0B-450-10-Z	157	RS-188128-14	366	RS-TRIES-160-06	368	UA-00-337256	345
PR-0B-450-18	156	RS-220160-01	366	RS-TRIES-192-06	368	UA-00-337256-20M	345
PR-0B-450-80-Z	157	RS-220160-02	366	RS-TRIES-256-06	368	UA-00-337320	345
PR-0B-500-10	156	RS-220160-05	366	RS-TRIES-320-06	368	UA-00-337320-20M	345
PR-0B-500-18	156	RS-220160-06	366			UA-00-338128	345
PR-0B-550-10	156	RS-220160-14	366	S		UA-00-338160	345
PR-0B-550-18	156	RS-272192-01	366	SB-A60x72-20M	475	UA-00-340128	346
PR-0B-600-10	156	RS-272192-02	366	SB-A60X72-80	475	UA-00-340160	346
PR-0B-600-18	156	RS-272192-05	366	SZ-005-00-01-AT	229	UA-00-340192	346
PU-KEY027-20	302	RS-272192-06	366	SZ-005-00-01T	229	UA-00-340224	346
PU-KEY027-60	302	RS-272192-14	366	SZ-008-00-01-AT	229	UA-00-340256	346
PU-KEYM27-20	302	RS-304224-01	366	SZ-008-00-01T	229	UA-00-340320	346
PU-KEYM27-60	302	RS-304224-02	366			UA-00-347128	346
PU-PKO-00-20	303	RS-304224-05	366	U		UA-00-347160	346
PU-PKO-00-60	303	RS-304224-06	366	UA-00-313128	340	UA-00-347192	346
		RS-304224-14	366	UA-00-313160	340	UA-00-347224	346
R		RS-336256-01	366	UA-00-313192	340	UA-00-347256	346
RR-161030H01	237	RS-336256-02	366	UA-00-319096	341	UA-00-347320	346
RR-161230H01	237	RS-336256-05	366	UA-00-319128	341	UA-01-326096-V1	369
RR-250730H01	237	RS-336256-06	366	UA-00-319160	341	UA-01-326128-V1	369
RR-250830H01	237	RS-336256-14	366	UA-00-326096-05	369	UA-01-326160	369
RR-250930H01	237	RS-368288-01	366	UA-00-326096-20M	369	UA-18-128146	340
RR-251030H01	237	RS-368288-02	366	UA-00-326128-05	369	UA-18-160178	340
RR-401230H01	237	RS-368288-05	366	UA-00-326128-20M	369	UA-18-192210	340
RR-501030H01	237	RS-368288-06	366	UA-00-326160	369	UA-18-224242	340
RR-501230H01	237	RS-368288-14	366	UA-00-326160-20M	369	UA-18-256274	340

UA-18-320338	340	UA-B0-337160	339	UA-HEXI-60	372	UA-LIND-224-496-20M	371
UA-18-400418	340	UA-B0-337192	339	UA-HEXI96-01	372	UA-LIND-256-296-01	371
UA-A18128-01	340	UA-B0-337224	339	UA-HEXI96-05	372	UA-LIND-256-296-05	371
UA-A18160-01	340	UA-B0-337256	339	UA-HEXI96-10M	372	UA-LIND-256-296-18	371
UA-A18192-01	340	UA-B0-337320	339	UA-HEXI96-18	372	UA-LIND-256-296-20M	371
UA-A18224-01	340	UA-B31109601*	338	UA-HEXI96-20M	372	UA-LIND-256-596-01	371
UA-A18256-01	340	UA-B31112801	338	UA-HEXI96-60	372	UA-LIND-256-596-05	371
UA-A18320-01	340	UA-B31116001	338	UA-HEXI160-01	372	UA-LIND-256-596-18	371
UA-AA-114-05	339	UA-B31119201	338	UA-HEXI160-05	372	UA-LIND-256-596-20M	371
UA-ARS096-20	323	UA-B31122401	338	UA-HEXI160-10M	372	UA-LIND-320-396-01	371
UA-ARS128-20	323	UA-B31125601	338	UA-HEXI160-18	372	UA-LIND-320-396-05	371
UA-ARS160-20	323	UA-B31128801*	338	UA-HEXI160-20M	372	UA-LIND-320-396-18	371
UA-ARS192-20	323	UA-B31132001	338	UA-HEXI160-60	372	UA-LIND-320-396-20M	371
UA-ARS224-20	323	UA-B31148001*	338	UA-HEXI192-01	372	UA-LIND-352-796-01	371
UA-ARS256-20	323	UA-DOPPIO192-01	341	UA-HEXI192-05	372	UA-LIND-352-796-05	371
UA-ARS320-20	323	UA-DOPPIO416-01	341	UA-HEXI192-10M	372	UA-LIND-352-796-18	371
UA-ARSG30-20	323	UA-HEXA-32-01	374	UA-HEXI192-18	372	UA-LIND-352-796-20M	371
UA-B0-311096	338	UA-HEXA-32-05	374	UA-HEXI192-20M	372	UA-PICADO-224-496-01	376
UA-B0-311096-20M	338	UA-HEXA-32-10M	374	UA-HEXI192-60	372	UA-PICADO-224-496-05	376
UA-B0-311128	338	UA-HEXA-32-18	374	UA-HEXI256-01	372	UA-PICADO-224-496-18	376
UA-B0-311128-20M	338	UA-HEXA-32-20M	374	UA-HEXI256-05	372	UA-PICADO-224-496-20M	376
UA-B0-311160	338	UA-HEXA-96-01	374	UA-HEXI256-10M	372	UA-PICADO-256-296-01	376
UA-B0-311160-20M	338	UA-HEXA-96-05	374	UA-HEXI256-20M	372	UA-PICADO-256-296-05	376
UA-B0-311192	338	UA-HEXA-96-10M	374	UA-HEXI290-18	372	UA-PICADO-256-296-18	376
UA-B0-311192-20M	338	UA-HEXA-96-18	374	UA-HEXI290-60	372	UA-PICADO-256-296-20M	376
UA-B0-311224	338	UA-HEXA-96-20M	374	UA-HEXI320-01	372	UA-PICADO-256-596-01	376
UA-B0-311224-20M	338	UA-HEXA-192-01	374	UA-HEXI320-05	372	UA-PICADO-256-596-05	376
UA-B0-311256	338	UA-HEXA-192-05	374	UA-HEXI320-10M	372	UA-PICADO-256-596-18	376
UA-B0-311256-20M	338	UA-HEXA-192-10M	374	UA-HEXI320-20M	372	UA-PICADO-256-596-20M	376
UA-B0-311288	338	UA-HEXA-192-18	374	UA-HEXI360-18	372	UA-PICADO-320-396-01	376
UA-B0-311288-20M*	338	UA-HEXA-192-20M	374	UA-HEXI360-60	372	UA-PICADO-320-396-05	376
UA-B0-311320	338	UA-HEXI-01	372	UA-HEXI-3500-05	372	UA-PICADO-320-396-18	376
UA-B0-311320-20M	338	UA-HEXI-05	372	UA-HEXI-3500-20M	372	UA-PICADO-320-396-20M	376
UA-B0-311480	338	UA-HEXI-10M	372	UA-LIND-224-496-01	371	UA-PICADO-352-796-01	376
UA-B0-311480-20M*	338	UA-HEXI-18	372	UA-LIND-224-496-05	371	UA-PICADO-352-796-05	376
UA-B0-337128	339	UA-HEXI-20M	372	UA-LIND-224-496-18	371	UA-PICADO-352-796-18	376

UA-PICADO-352-796-20M	376	UM-STAR-ZT	408	UZ-05-096-02	359	UZ-133128-20M	328
UA-STRUCTURE-128-20M	358	UM-TWITT-SZ	408	UZ-05-096-05	359	UZ-334128-06	330
UA-STRUCTURE-192-20M	358	UM-TWITT-ZL	408	UZ-05-128-01	359	UZ-334160-06	330
UA-TREX-32-50-05	377	UM-UNICORN-RZ	411	UZ-05-128-02	359	UZ-334192-06	330
UA-TREX-32-50-20M	377	UP-WP0728-BB	386	UZ-05-128-05	359	UZ-334256-06	330
UA-TREX-96-150-05	377	UP-WP0728-BK	386	UZ-06-128-01	360	UZ-334320-06	330
UA-TREX-96-150-20M	377	UP-WP0728-BR	386	UZ-06-128-02	360	UZ-336128-06	330
UA-TREX-224-250-05	377	UP-WP0728-BX	386	UZ-06-128-05	360	UZ-336160-06	330
UA-TREX-224-250-20M	377	UP-WP0728-P0	387	UZ-07-096-01	360	UZ-336192-06	330
UA-TREX-320-350-05	377	UP-WP0728-PA-04	387	UZ-07-096-02	360	UZ-336256-06	330
UA-TREX-320-350-20M	377	UP-WP0728-PA-07	387	UZ-07-096-05	360	UZ-336320-06	330
UA-TREX-3500-05	377	UP-WP0728-PB	387	UZ-10-096-N04	389	UZ-336416-06	330
UA-TREX-3500-20M	377	UP-WP0728-PC-04	387	UZ-12-096-04	389	UZ-336480-06	330
UM-BLOCK-CZ	408, 429	UP-WP0728-PK	387	UZ-12-096-04N	389	UZ-682128-06	331
UM-BLOCK-NB	408	UP-WP0728-PR	387	UZ-12-096-20M	389	UZ-682160-06	331
UM-BLOCK-ZL	408	UP-WP0728-PX	387	UZ-13-096-01	361	UZ-682192-06	331
UM-BUTTON-NB	408	UZ-00B224-01	370	UZ-13-096-02	361	UZ-682224-06	331
UM-BUTTON-SZ	408	UZ-00B224-02	370	UZ-13-096-05	361	UZ-682256-06	331
UM-CLOUD-NB	408	UZ-00B224-05	370	UZ-14-096-01	362	UZ-682320-06	331
UM-CLOUD-SZ	408	UZ-00B224-10	370	UZ-14-096-02	362	UZ-682416-06	331
UM-CROWN-RZ	408	UZ-00B224-20	370	UZ-14-096-05	362	UZ-682480-06	331
UM-FLAMING-RZ	408	UZ-00B226-01	370	UZ-14-128-01	362	UZ-819096-01	334
UM- FLAMING-SZ	408	UZ-00B226-02	370	UZ-14-128-02	362	UZ-819096-02	334
UM-HEART-RZ	408	UZ-00B226-05	370	UZ-14-128-05	362	UZ-819096-05	334
UM-KID-C-001	410	UZ-00B226-10	370	UZ-40-032-01	327	UZ-819096-06	334
UM-KID-D-001	410	UZ-00B226-20	370	UZ-40-032-02	327	UZ-819096-07	334
UM-KID-E-001	410	UZ-01-096-01	359	UZ-40-032-05	327	UZ-819096-10	334
UM-KID-I-002	410	UZ-01-096-02	359	UZ-40-032-06	327	UZ-819096-12	334
UM-KID-P-001	410	UZ-01-096-05	359	UZ-40-032-20M	327	UZ-819096-14	334
UM-KID-Q-001	410	UZ-01-128-01	359	UZ-55-025-05	327	UZ-819096-20	334
UM-KID-U-001	410	UZ-01-128-02	359	UZ-60-032-01	328	UZ-819128-01	334
UM-KID-W-001	411	UZ-01-128-05	359	UZ-71C096-01	402	UZ-819128-02	334
UM-KID-X-001	411	UZ-02C064-01	403	UZ-133128-01	328	UZ-819128-05	334
UM-KID-Z-001	411	UZ-02C096-01	403	UZ-133128-02	328	UZ-819128-06	334
UM-STAR-NB	408	UZ-02CF27-01	403	UZ-133128-05	328	UZ-819128-07	334
UM-STAR-RZ	408	UZ-05-096-01	359	UZ-133128-06	328	UZ-819128-10	334

UZ-819128-12	334	UZ-819256-16	334	UZ-BAGIO-160-01	325	UZ-CAMAI-96-09	362
UZ-819128-14	334	UZ-819256-20	334	UZ-BAGIO-160-04	325	UZ-CAMAI-96-10M	362
UZ-819128-15	334	UZ-819320-01	334	UZ-BAGIO-160-05	325	UZ-CAMAI-96-12	362
UZ-819128-16	334	UZ-819320-02	334	UZ-BAGIO-160-06	325	UZ-CAMAI-96-20M	362
UZ-819128-20	334	UZ-819320-05	334	UZ-BAGIO-160-07	325	UZ-CAMAI-96-90	362
UZ-819160-01	334	UZ-819320-06	334	UZ-BAGIO-160-11	325	UZ-CAMAI-128-01	362
UZ-819160-02	334	UZ-819320-07	334	UZ-BAGIO-160-15	325	UZ-CAMAI-128-02	362
UZ-819160-05	334	UZ-819320-10	334	UZ-BAGIO-160-20M	325	UZ-CAMAI-128-06	362
UZ-819160-06	334	UZ-819320-12	334	UZ-BAGIO-160-90	325	UZ-CAMAI-128-09	362
UZ-819160-07	334	UZ-819320-14	334	UZ-BAGIO-192-01	325	UZ-CAMAI-128-10M	362
UZ-819160-10	334	UZ-819320-20	334	UZ-BAGIO-192-04	325	UZ-CAMAI-128-12	362
UZ-819160-12	334	UZ-ABIAT-128-04	393	UZ-BAGIO-192-05	325	UZ-CAMAI-128-20M	362
UZ-819160-14	334	UZ-ACERA-96-04	394	UZ-BAGIO-192-06	325	UZ-CAMAI-128-90	362
UZ-819160-15	334	UZ-ADRIN-96-04	393	UZ-BAGIO-192-07	325	UZ-CAPRI-96-01	333
UZ-819160-16	334	UZ-ALATR-128-04	387	UZ-BAGIO-192-11	325	UZ-CAPRI-96-02	333
UZ-819160-20	334	UZ-ANCON-128-01	326	UZ-BAGIO-192-15	325	UZ-CAPRI-96-05	333
UZ-819192-01	334	UZ-ANCON-128-05	326	UZ-BAGIO-192-20M	325	UZ-CAPRI-96-06	333
UZ-819192-02	334	UZ-ANCON-128-06	326	UZ-BAGIO-192-90	325	UZ-CAPRI-96-20M	333
UZ-819192-05	334	UZ-ANCON-192-01	326	UZ-BAGIO-320-01	325	UZ-CAPRI-128-01	333
UZ-819192-06	334	UZ-ANCON-192-05	326	UZ-BAGIO-320-04	325	UZ-CAPRI-128-02	333
UZ-819192-07	334	UZ-ANCON-192-06	326	UZ-BAGIO-320-05	325	UZ-CAPRI-128-05	333
UZ-819192-10	334	UZ-ANCON-256-01	326	UZ-BAGIO-320-06	325	UZ-CAPRI-128-06	333
UZ-819192-12	334	UZ-ANCON-256-05	326	UZ-BAGIO-320-07	325	UZ-CAPRI-128-20M	333
UZ-819192-14	334	UZ-ANCON-256-06	326	UZ-BAGIO-320-11	325	UZ-CAPRI-160-01	333
UZ-819192-15	334	UZ-ARCH096-AEB	392	UZ-BAGIO-320-15	325	UZ-CAPRI-160-02	333
UZ-819192-16	334	UZ-ARDEA-96-09	391	UZ-BAGIO-320-20M	325	UZ-CAPRI-160-05	333
UZ-819192-20	334	UZ-AREZO-96-04	392	UZ-BAGIO-320-90	325	UZ-CAPRI-160-06	333
UZ-819256-01	334	UZ-BAGIO-128-01	325	UZ-CALABRIA160-01	347	UZ-CAPRI-160-20M	333
UZ-819256-02	334	UZ-BAGIO-128-04	325	UZ-CALABRIA160-06	347	UZ-CAPRI-192-01	333
UZ-819256-05	334	UZ-BAGIO-128-05	325	UZ-CALABRIA192-01	347	UZ-CAPRI-192-02	333
UZ-819256-06	334	UZ-BAGIO-128-06	325	UZ-CALABRIA192-06	347	UZ-CAPRI-192-05	333
UZ-819256-07	334	UZ-BAGIO-128-07	325	UZ-CALABRIA224-01	347	UZ-CAPRI-192-06	333
UZ-819256-10	334	UZ-BAGIO-128-11	325	UZ-CALABRIA224-06	347	UZ-CAPRI-192-20M	333
UZ-819256-12	334	UZ-BAGIO-128-15	325	UZ-CAMAI-96-01	362	UZ-CAPRI-256-01	333
UZ-819256-14	334	UZ-BAGIO-128-20M	325	UZ-CAMAI-96-02	362	UZ-CAPRI-256-02	333
UZ-819256-15	334	UZ-BAGIO-128-90	325	UZ-CAMAI-96-06	362	UZ-CAPRI-256-05	333

UZ-CAPRI-256-06	333	UZ-FABRICIO-192-20M	351	UZ-G0-256-06	348	UZ-GENUA128-02	347
UZ-CAPRI-256-20M	333	UZ-FABRICIO-320-18	351	UZ-G1-128-01	348	UZ-GENUA128-05	347
UZ-CAPRI-320-01	333	UZ-FABRICIO-320-20M	351	UZ-G1-128-05	348	UZ-GENUA128-20M	347
UZ-CAPRI-320-02	333	UZ-FIORD-32-05	377	UZ-G1-128-06	348	UZ-GENUA160-01	347
UZ-CAPRI-320-05	333	UZ-FIORD-32-06	377	UZ-G1-128-13	348	UZ-GENUA160-02	347
UZ-CAPRI-320-06	333	UZ-FIORD-32-18	377	UZ-G1-128-20M	348	UZ-GENUA160-05	347
UZ-CAPRI-320-20M	333	UZ-FIORD-32-20M	377	UZ-G1-160-01	348	UZ-GENUA160-20M	347
UZ-CLEO-128-01	336	UZ-FLAVIO-96-01	344	UZ-G1-160-05	348	UZ-KATAN-320-01	326
UZ-CLEO-128-05	336	UZ-FLAVIO-96-06	344	UZ-G1-160-06	348	UZ-KATAN-320-12	326
UZ-CLEO-128-06	336	UZ-FLAVIO-96-16	344	UZ-G1-160-13	348	UZ-LUCCA128-01	405
UZ-CLEO-160-01	336	UZ-FLAVIO-96-20M	344	UZ-G1-160-20M	348	UZ-LUCCA160-01	405
UZ-CLEO-160-05	336	UZ-FLAVIO-128-01	344	UZ-G1-192-01	348	UZ-LUCCA192-01	405
UZ-CLEO-160-06	336	UZ-FLAVIO-128-06	344	UZ-G1-192-05	348	UZ-MARSA-64-07	395
UZ-CLEO-192-01	336	UZ-FLAVIO-128-16	344	UZ-G1-192-06	348	UZ-MARSA-64-09	395
UZ-CLEO-192-05	336	UZ-FLAVIO-128-20M	344	UZ-G1-192-13	348	UZ-MARSA-64-10M	395
UZ-CLEO-192-06	336	UZ-FLAVIO-160-01	344	UZ-G1-192-20M	348	UZ-MARSA-64-11	395
UZ-COM0096-01	404	UZ-FLAVIO-160-06	344	UZ-G1-256-01	348	UZ-MARSA-64-15	395
UZ-COM0128-01	404	UZ-FLAVIO-160-16	344	UZ-G1-256-05	348	UZ-MARSA-64-18	395
UZ-COM0160-01	404	UZ-FLAVIO-160-20M	344	UZ-G1-256-06	348	UZ-MARSA-64-20M	395
UZ-CRA14-128	403	UZ-FLOW-128-06	356	UZ-G1-256-13	348	UZ-MILAN-128-01	331
UZ-CRA14-192	403	UZ-FLOW-128-20M	356	UZ-G1-256-20M	348	UZ-MILAN-128-05	331
UZ-CRA14-320	403	UZ-FLOW-128-90	356	UZ-G1-320-01	348	UZ-MILAN-128-06	331
UZ-E6-096-01	369	UZ-FLOW-192-06	356	UZ-G1-320-05	348	UZ-MILAN-128-20M	331
UZ-E6-096-05	369	UZ-FLOW-192-20M	356	UZ-G1-320-06	348	UZ-MILAN-256-01	331
UZ-E6-096-06	369	UZ-FLOW-192-90	356	UZ-G1-320-13	348	UZ-MILAN-256-05	331
UZ-E6-128-01	369	UZ-G0-128-01	348	UZ-G1-320-20M	348	UZ-MILAN-256-06	331
UZ-E6-128-05	369	UZ-G0-128-05	348	UZ-G1-416-01	348	UZ-MILAN-256-20M	331
UZ-E6-128-06	369	UZ-G0-128-06	348	UZ-G1-416-05	348	UZ-MODEN-128-01	329
UZ-E6-160-01	369	UZ-G0-160-01	348	UZ-G1-416-06	348	UZ-MODEN-128-05	329
UZ-E6-160-05	369	UZ-G0-160-05	348	UZ-G2-160-01	324	UZ-MODEN-128-06	329
UZ-E6-160-06	369	UZ-G0-160-06	348	UZ-G2-160-06	324	UZ-MODEN-128-20M	329
UZ-EVER-128-20M	353	UZ-G0-192-01	348	UZ-G2-160-20M	324	UZ-MODEN-160-01	329
UZ-EVER-128-90	353	UZ-G0-192-05	348	UZ-G2-224-01	324	UZ-MODEN-160-05	329
UZ-FABRICIO-128-18	351	UZ-G0-192-06	348	UZ-G2-224-06	324	UZ-MODEN-160-06	329
UZ-FABRICIO-128-20M	351	UZ-G0-256-01	348	UZ-G2-224-20M	324	UZ-MODEN-160-20M	329
UZ-FABRICIO-192-18	351	UZ-G0-256-05	348	UZ-GENUA128-01	347	UZ-MODEN-192-01	329

UZ-MODEN-192-05	329	UZ-OCTAVIO-160-06	332	UZ-TH096128-01	344	UZ-WP1146-04	397
UZ-MODEN-192-06	329	UZ-OCTAVIO-160-18	332	UZ-TH096128-05	344	UZ-Z10096-01	361
UZ-MODEN-192-20M	329	UZ-OCTAVIO-160-20M	332	UZ-TH096128-06	344	UZ-Z10096-02	361
UZ-MONA-128-01-10	322	UZ-OCTAVIO-192-01	332	UZ-TH160192-01	344	UZ-Z10096-05	361
UZ-MONA-128-01-20	322	UZ-OCTAVIO-192-06	332	UZ-TH160192-05	344	UZ-Z10096-20M	361
UZ-MONA-192-01-10	322	UZ-OCTAVIO-192-18	332	UZ-TH160192-06	344	UZ-Z10128-01	361
UZ-MONA-192-01-20	322	UZ-OCTAVIO-192-20M	332	UZ-TH288320-01	344	UZ-Z10128-02	361
UZ-MONA-256-01-10	322	UZ-OLBIA-96-04	394	UZ-TH288320-06	344	UZ-Z10128-05	361
UZ-MONA-256-01-20	322	UZ-OLBIA-128-04	394	UZ-TIVOL-192-01	324	UZ-Z10128-20M	361
UZ-MONZA16-10	322	UZ-OTTO-128-06	352	UZ-TIVOL-192-12	324		
UZ-MONZA160-06	322	UZ-OTTO-128-20M	352	UZ-TIVOL-192-13	324	W	
UZ-MONZA160-10	322	UZ-OTTO-128-90	352	UZ-TIVOL-320-01	324	WA-MALAG-A0-01	420
UZ-MONZA160-20	322	UZ-OTTO-160-06	352	UZ-TIVOL-320-12	324	WA-MALAG-A0-02	420
UZ-MONZA256-06	322	UZ-OTTO-160-20M	352	UZ-TIVOL-320-13	324	WA-MALAG-A0-05	420
UZ-MONZA256-10	322	UZ-OTTO-160-90	352	UZ-VASTO-96-09	388	WA-MALAG-A0-20	420
UZ-MONZA256-20	322	UZ-PALER-96-07	388	UZ-VASTO-128-09	388	WA-MALAG-B0-01	421
UZ-MONZA384-06	322	UZ-PALER-128-07	388	UZ-VENICE-128-20M	350	WA-MALAG-B0-02	421
UZ-MONZA384-10	322	UZ-PRATO-160-01	338	UZ-VENICE-128-90	350	WA-MALAG-B0-05	421
UZ-MONZA384-20	322	UZ-PRATO-160-06	338	UZ-VITO-160-01	342	WA-MALAG-B0-20	421
UZ-NORD-128-03	349	UZ-PRATO-320-01	338	UZ-VITO-160-05	342	WB-073024-01	217
UZ-NORD-128-18	349	UZ-PRATO-320-06	338	UZ-VITO-160-07	342	WB-073024-06	217
UZ-NORD-128-20M	349	UZ-REN096-04A	399	UZ-VITO-160-12	342	WB-073025-01	218
UZ-NORD-160-03	349	UZ-RETRIS-128-04	390	UZ-VITO-160-16	342	WB-073025-06	218
UZ-NORD-160-18	349	UZ-RETRIS-128-07	390	UZ-VITO-160-20M	342	WB-073026-01	218
UZ-NORD-160-20M	349	UZ-RETRIS-128-20M	390	UZ-VITO-288-01	342	WB-073026-06	218
UZ-NORD-192-03	349	UZ-ROYAL1-96-10-03	396	UZ-VITO-288-05	342	WB-WS-12-010	219
UZ-NORD-192-18	349	UZ-ROYAL2-96-10-03	396	UZ-VITO-288-07	342	WB-WS-18-010	219
UZ-NORD-192-20M	349	UZ-ROYAL3-96-10-03	396	UZ-VITO-288-12	342	WB-WS-18-020	219
UZ-NORD-320-03	349	UZ-ROYAL4-96-03	396	UZ-VITO-288-16	342	WB-WS-18-060	219
UZ-NORD-320-18	349	UZ-ROYAL5-96-10-03	396	UZ-VITO-288-20M	342	WB-WS-24-010	220
UZ-NORD-320-20M	349	UZ-ROYAL5-128-10-03	396	UZ-WERON-96-04	391	WB-WS-24-020	220
UZ-OCTAVIO-128-01	332	UZ-SIENNA096-01	404	UZ-WERON-96-09	391	W-CUSTOMI-60L450	200
UZ-OCTAVIO-128-06	332	UZ-SIENNA128-01	404	UZ-WERON-96-12	391	W-CUSTOMI-60L500	200
UZ-OCTAVIO-128-18	332	UZ-SIENNA160-01	404	UZ-WERON-128-04	391	W-CUSTOMI-80L450	201
UZ-OCTAVIO-128-20M	332	UZ-STEP-160-07	355	UZ-WERON-128-09	391	W-CUSTOMI-80L500	201
UZ-OCTAVIO-160-01	332	UZ-STEP-160-20M	355	UZ-WERON-128-12	391	WG-KOSZ60-10	257

WG-KOSZ60-60	257	WG-POBUWM80-60	260	KPL-1T	231	WM-STAR-NB	429
WG-KOSZ70-10	257	WG-POBUWM90-10	260	WK-CAM-15-DOW63X39-		WM-STAR-RZ	429
WG-KOSZ70-60	257	WG-POBUWM90-60	260	KPL-1T	231	WM-STAR-ZT	429
WG-KOSZ80-10	257	WG-PRZEG60-10	261	WK-CAM-15-DOW63X45-		WM-UNICORN-RZ	429
WG-KOSZ80-60	257	WG-PRZEG60-60	261	KPL-1T	231	W-WK060-BP-10	271
WG-KOSZ90-10	257	WG-PRZEG70-10	261	WK-CF0750-01	231	W-WK060-BP-60	270
WG-KOSZ90-60	257	WG-PRZEG70-60	261	WK-CF6450-01	231	W-WK070-BP-10	271
WG-KOSZM60-10	256	WG-PRZEG80-10	261	WK-D0320-001*	229	W-WK070-BP-60	270
WG-KOSZM60-60	256	WG-PRZEG80-60	261	WK-D0325-001*	229	W-WK080-BP-10	271
WG-KOSZM70-10	256	WG-PRZEG90-10	261	WK-D0330-001*	229	W-WK080-BP-60	270
WG-KOSZM70-60	256	WG-PRZEG90-60	261	WK-D0416-001	229	W-WK090-BP-10	271
WG-KOSZM80-10	256	WG-RDRO-10	263	WK-D0425-001*	229	W-WK090-BP-60	270
WG-KOSZM80-60	256	WG-RDRO-60	263	WK-D0430-001	229	W-WKRP-BP-10	272
WG-KOSZM90-10	256	WG-RDRP-10	263	WK-D0440-001	229	W-WKRP-BP-60	272
WG-KOSZM90-60	256	WG-RDRP-60	263	WK-D0460-001	229	W-WKRP-VE-10	272
WG-KOSZR60-10	258	WG-RRPSET-A-10	263	WK-D3516-001	229	W-WKRP-VE-60	272
WG-KOSZR60-60	258	WG-RRPSET-A-60	263	WK-D3530-001	229	W-WOBU60-BP-10	267
WG-KOSZR70-10	258	WG-RRPSET-B-10	263	WK-DOW63X31G-D	230	W-WOBU60-BP-60	266
WG-KOSZR70-60	258	WG-RRPSET-B-60	263	WK-DOW63X35B-D	230	W-WOBU70-BP-10	267
WG-KOSZR80-10	258	WG-WSP0D60	262	WK-DOW63X39-D	230	W-WOBU70-BP-60	266
WG-KOSZR80-60	258	WG-WSP0D60-10	262	WK-DOW63X45B-D	230	W-WOBU80-BP-10	267
WG-KOSZR90-10	258	WG-WSP0D60-60	262	WK-SZ-AS-400-10	202	W-WOBU80-BP-60	266
WG-KOSZR90-60	258	WG-WSP0D70	262	WK-SZ-AS-400-60	202	W-WOBU90-BP-10	267
WG-POBUW60-10	259	WG-WSP0D70-10	262	WK-SZ-AS-500-10	202	W-WOBU90-BP-60	266
WG-POBUW60-60	259	WG-WSP0D70-60	262	WK-SZ-AS-500-60	202	W-WSPD60-BP-10	269
WG-POBUW70-10	259	WG-WSP0D80	262	WK-SZ-AS-600-10	202	W-WSPD60-BP-60	268
WG-POBUW70-60	259	WG-WSP0D80-10	262	WK-SZ-AS-600-60	202	W-WSPD70-BP-10	269
WG-POBUW80-10	259	WG-WSP0D80-60	262	WK-SZ-AS-800-10	202	W-WSPD70-BP-60	268
WG-POBUW80-60	259	WG-WSP0D90	262	WK-SZ-AS-800-60	202	W-WSPD80-BP-10	269
WG-POBUW90-10	259	WG-WSP0D90-10	262	WK-SZ-AS-900-10	202	W-WSPD80-BP-60	268
WG-POBUW90-60	259	WG-WSP0D90-60	262	WK-SZ-AS-900-60	202	W-WSPD90-BP-10	269
WG-POBUWM60-10	260	WK-CAM-15-12-D	230	WM-BALL-CZ-B	429	W-WSPD90-BP-60	268
WG-POBUWM60-60	260	WK-CAM-15-13-D	230	WM-BLOCK-NB	429	WW-WSD250-01B	276
WG-POBUWM70-10	260	WK-CAM-15-DOW63X31-		WM-BLOCK-ZL	429	WW-WSD300-01B	276
WG-POBUWM70-60	260	KPL-1T	231	WM-CLOUD-NB	429	WW-WSD350-01B	276
WG-POBUWM80-10	260	WK-CAM-15-DOW63X35-		WM-CLOUD-SZ	429	WW-WSD400-01B	276

WW-WSD450-01B	276	WZ-B0-K23-04	416	WZ-E-018-02	422	WZ-TOLED-B0-05	412
WW-WSD500-01B	276	WZ-B0-K23-05	416	WZ-E-018-05	422	WZ-TOLED-B0-06	412
WW-WSL250-01	275	WZ-B0-K23-06	416	WZ-E-018-06	422	WZ-TOLED-B0-20M	412
WW-WSL300-01	275	WZ-B0-K23-07	416	WZ-E-018-20M	422	WZ-TOLED-C0-01	413
WW-WSL350-01	275	WZ-B0-K23-20	416	WZ-K23-D1-01	417	WZ-TOLED-C0-02	413
WW-WSL400-01	275	WZ-B0-K24-01	418	WZ-K23-D1-02	417	WZ-TOLED-C0-05	413
WW-WSL450-01	275	WZ-B0-K24-02	418	WZ-K23-D1-05	417	WZ-TOLED-C0-06	413
WW-WSL500-01	275	WZ-B0-K24-03	418	WZ-K23-D1-06	417	WZ-TOLED-C0-20M	413
WW-WSL000-01	274	WZ-B0-K24-04	418	WZ-K23-E1-01	417	WZ-WALENCIA-01	414
WW-WSP000-01	274	WZ-B0-K24-05	418	WZ-K23-E1-05	417	WZ-WALENCIA-06	414
WW-WSP00-01	274	WZ-B0-K24-07	418	WZ-K23-E1-06	417	WZ-WALENCIA-20M	414
WW-WUBR00-01	275	WZ-B0-K24-20	418	WZ-K2201-01	415		
WW-ZWBUT2-10	277	WZ-C0-K24-01	420	WZ-K2201-06	415	Z	
WW-ZWBUT2-20	277	WZ-C0-K24-02	420	WZ-K2201-CZ	415	ZC-GTV-12-00	102
WZ-00-K24-04	428	WZ-C0-K24-03	420	WZ-K2202-01	415	ZC-GTV-14-00	102
WZ-804-20-01	411	WZ-C0-K24-04	420	WZ-K2202-06	415	ZK-FORCE-KPL	225
WZ-804-20-05	411	WZ-C0-K24-05	420	WZ-K2202-CZ	415	ZK-FORZA-ZAS-KPL-010	227
WZ-804-20-06	411	WZ-C0-K24-20	420	WZ-MADRYT-04	424	ZK-FORZA-ZAS-KPL-020	227
WZ-A0-K23-01	416	WZ-CAPITAL-18	425	WZ-MADRYT-07	424	ZK-FORZA-ZAW-KPL	226
WZ-A0-K23-02	416	WZ-CAPITAL-20M	425	WZ-MADRYT-15	424	ZK-R1-KPL-10	226
WZ-A0-K23-03	416	WZ-CORDOBA-01	414	WZ-MADRYT-20M	424	ZK-ZAW-R0-10	225
WZ-A0-K23-04	416	WZ-CORDOBA-06	414	WZ-MALAG-C0-01	421	ZK-ZAW-R0-30	225
WZ-A0-K23-05	416	WZ-CORDOBA-20M	414	WZ-MALAG-C0-02	421	ZM-CNHC07BR2	77
WZ-A0-K23-06	416	WZ-CORUNA-D-04	422	WZ-MALAG-C0-05	421	ZM-CNHC08BR2	77
WZ-A0-K23-07	416	WZ-CORUNA-D-07	422	WZ-MALAG-C0-20	421	ZM-CNHC09BR2	76
WZ-A0-K23-20	416	WZ-CORUNA-D-17	422	WZ-ORVIE-A0-09	427	ZM-DCHC07-3DBEO	70
WZ-A0-K24-01	418	WZ-CORUNA-D-20M	422	WZ-ORVIE-B0-09	427	ZM-DCHC07-3DZEO	70
WZ-A0-K24-02	418	WZ-CORUNA-M-04	423	WZ-SCTYLPR-BWK	224	ZM-DCHC08-3DBEO	69
WZ-A0-K24-03	418	WZ-CORUNA-M-07	423	WZ-SCTYLPR-WK	224	ZM-DCHC08-3DZEO	69
WZ-A0-K24-04	418	WZ-CORUNA-M-17	423	WZ-TOLED-A0-01	412	ZM-DCHC09-3DBEO	69
WZ-A0-K24-05	418	WZ-CORUNA-M-20M	423	WZ-TOLED-A0-02	412	ZM-DCHC09-3DZEO	69
WZ-A0-K24-07	418	WZ-CRAFT-04	426	WZ-TOLED-A0-05	412	ZM-ECHC07-3DBEO	75
WZ-A0-K24-20	418	WZ-CRAFT-07	426	WZ-TOLED-A0-06	412	ZM-ECHC07BEO	72
WZ-B0-K23-01	416	WZ-CRAFT-15	426	WZ-TOLED-A0-20M	412	ZM-ECHC07H04-BE	74
WZ-B0-K23-02	416	WZ-CRAFT-20M	426	WZ-TOLED-B0-01	412	ZM-ECHC07ZEO	72
WZ-B0-K23-03	416	WZ-E-018-01	422	WZ-TOLED-B0-02	412	ZM-ECHC08-3DBEO	75

ZM-ECHC08BEO	72	ZM-INHC080ZE0	78	ZP-CIG-170ZE	98	ZP-KTK90H6ZE	89
ZM-ECHC08H04-BE	73	ZM-INHC090BEO	78	ZP-CIG-17UZE	98	ZP-P07H045BE	94
ZM-ECHC08ZE0	72	ZM-INHC090ZE0	78	ZP-CIG-190ZE	98	ZP-POH045BEO	94
ZM-ECHC09-3DBEO	74	ZM-KT45H2-BE	88	ZP-CIG-19UZE	98	ZP-POH045ZE0	94
ZM-ECHC09BEO	70	ZM-OT-Standard	67	ZP-CIHC070ZE	96	ZP-RALUH2-00	99
ZM-ECHC09H04-BE	73	ZM-SZABLON-ZAW	103	ZP-CIHC080ZE	95	ZP-SKR-00-80	102
ZM-ECHC09ZE0	70	ZN-OT-heavy	67	ZP-CIHC090ZE	95	ZT-HF-01-D00	100, 101
ZM-HCKT30-BE-S	79	ZP-BICN070BEO	87	ZP-COCA450-BE	91	ZZ-16-103-01-S	311
ZM-HCKT30-ZE-S	79	ZP-BICN070ZE0	87	ZP-COCA450-BE-F	92	ZZ-20-103-01-S	311
ZM-HCKT45-3DBEO-S	80	ZP-BICN072BEO	87	ZP-COCA450-ZE	91	ZZ-30-103-01-S	311
ZM-HCKT45-BE-S	80	ZP-BICN072ZE0	87	ZP-COCA7450-BE	91	ZZ-B0-105-01-S	310
ZM-HCKT45-ZE-S	80	ZP-BICN080BEO	87	ZP-COCA7450-BE-F	93	ZZ-BA-SK0-01-S	313
ZM-HCKT90-3DBEO-S	81	ZP-BICN080ZE0	87	ZP-COCA8450-BE	91	ZZ-BA-SK0-PR	313
ZM-HCKT90-BE-S	81	ZP-BICN082BEO	87	ZP-COCA8450-BE-F	92	ZZ-C1-288-01-S	314
ZM-HCKT90-ZE-S	81	ZP-BICN082ZE0	87	ZP-CONL07-BE	86	ZZ-C5-288-01-S	314
ZM-HCKT155BE	82	ZP-BICN090BEO	86	ZP-CONL07-ZE	86	ZZ-C6-288-01-S	314
ZM-HCKT155ZE	82	ZP-BICN090ZE0	86	ZP-CONL08-BE	85	ZZ-C8-288-01-S	314
ZM-HCKT165-3DBEO-S	83	ZP-BICN092BEO	86	ZP-CONL08-ZE	85	ZZ-CF-138-01	309
ZM-HCKT165BE-S	82	ZP-BICN092ZE0	86	ZP-CONL09-BE	85	ZZ-G0-328-01-S	313
ZM-HCKT165ZE-S	82	ZP-BIDI07-3DBEO	84	ZP-CONL09-ZE	85	ZZ-KLMASTER	309
ZM-HCKTK90-ZE	81	ZP-BIDI08-3DBEO	84	ZP-JUNIOR-00	101	ZZ-KM-138-01-S	308
ZM-HCPR007H04-BE-2BAG68		ZP-BIDI09-3DBEO	83	ZP-KT30H2-BE	88	ZZ-M0-201-01-S	312
ZM-HCPR007H04-ZE-2BAG68		ZP-CIBI7H0ZE	97	ZP-KT45H2-ZE	88	ZZ-SP-105-05	314, 515
ZM-HCPR008H04-BE-2BAG68		ZP-CIBI8H0ZE	97	ZP-KT90H2-BE	89	ZZ-SP-KLMASTER	314
ZM-HCPR008H04-ZE-2BAG68		ZP-CIBI9H0ZE	96	ZP-KT90H2-ZE	89	ZZ-SZ-409-01-S	311
ZM-HCPR009H04-BE-2BAG67		ZP-CIG-070ZE	98	ZP-KT135H2BE	90	ZZ-Z0-202-01-S	312
ZM-HCPR009H04-ZE-2BAG67		ZP-CIG-07UZE	98	ZP-KT135H2ZE	90	ZZ-ZN-138-01	308
ZM-HCRALU9BE	99	ZP-CIG-090ZE	98	ZP-KT165H2BE	90	ZZ-ZN-338-01-S	310
ZM-INHC070BEO	79	ZP-CIG-09UBE	98	ZP-KT165H2ZE	90		
ZM-INHC070ZE0	79	ZP-CIG-09UZE	98	ZP-KT0270-BE	100		
ZM-INHC080BEO	78	ZP-CIG-09UZE	98	ZP-KTK90H6BE	89		

Niniejszy katalog produktów został przygotowany przez GTV Poland. Poprzez ciągłe udoskonalanie swojej oferty, zgodnie z wymogami rynkowymi i prawnymi, GTV Poland zastrzega sobie prawo do wprowadzania zmian w przedstawionym asortymencie. Prezentowana publikacja nie jest ofertą w rozumieniu Kodeksu Cywilnego. Rzeczywiste produkty mogą odbiegać od poglądowych zdjęć i rysunków zamieszczonych w publikacji. GTV Poland zastrzega sobie prawo do zmian i błędów w druku.

This product catalogue has been prepared by GTV Poland. Constantly improving its products so as to follow market and legal requirements, GTV Poland reserves the right to introduce changes in the presented product range. The present publication does not constitute an offer within the meaning of the Civil Code. The real products can differ from the example photographs and drawings in the publication. GTV Poland reserves the right to make changes and printing errors.

Данный каталог был создан компанией GTV Poland. В соответствии с действующим законодательством и требованиями рынка, компания GTV Poland оставляет за собой право вносить изменения в ассортимент предлагаемого товара. Данная публикация носит информационно-ознакомительный характер и не является коммерческим предложением в понимании права. Компания не несет ответственности за возможные цветовые расхождения, опечатки и неточности.



ul. Przejazdowa 21
05-800 Pruszków
Poland

 +48 22 44 47 272

 +48 22 44 47 366
+48 22 44 47 331

 +48 22 44 47 391

 +48 22 44 47 379

 +420 591 160 091

 +48 22 444 73 24
+48 22 444 73 07

 +375 291 504 626
+48 22 44 47 523

 +48 22 44 47 524
+48 735 201 464

 +48 22 4447 525

 +48 22 44 47 297
+48 539 770 636

 тел: 8-495-640 15 88

 GTV Croatia d.o.o
Kovinska 4a, 10000 Zagreb
Hrvatska
+ 385 1 798 8089

 GTV Czech Distribution s.r.o.
CTPark Ostrava, Na Rovince 879
720 00 Ostrava-Hrabová
Česká republika
+420 591 160 092
+420 727 800 362
+420 725 715 142

 GTV España Herrajes e Iluminación,
S.L., Avenida Aragón 30, Planta 8
46021 Valencia (España)
+ 34 960 468 666
+ 48 22 444 73 77

fax: +48 22 444 75 01

e-mail: info@gtv.com.pl

www.gtv.com.pl

Follow us on

